



2026 Owner's Manual

# ***OPEN TRAIL***



## 2026 Owner's Manual

### DISCLAIMER

Many of the features and appliances described in this manual might not be reflected in the actual motorhome purchased, depending on the options and models selected by the motorhome owner. All items, materials, instructions, and guidance described in this manual are as accurate as possible at the time of printing. However, due to Tiffin Motorhomes' ongoing and dedicated commitment to excellence, improvement of Tiffin's motorhomes is a continuing process. Consequently, Tiffin Motorhomes reserves the right to make substitutions and improvements in its makes and models of motorhomes without prior notification. Substitutions of comparable or better materials, finishes, appliances, instrumentation, and instruction might be made at any time it is deemed prudent to provide the customer with the best possible motorhome, meeting the customer's requirements.

Copyright © by Tiffin Motorhomes, Inc. - all rights reserved.

Tiffin Motorhomes, Inc. ©  
105 2nd St. NW  
Red Bay, AL 35582  
Phone: 256-356-8661

Tiffin Motorhomes – “Made To Move You”

Fax: 256-356-8219  
Email: [customersupport@tiffinmotorhomes.com](mailto:customersupport@tiffinmotorhomes.com)  
[www.tiffinmotorhomes.com](http://www.tiffinmotorhomes.com)

<b>GENERAL INFORMATION .....</b>	<b>8</b>
Welcome to a life of “roughing it smoothly” .....	9
About This Manual: .....	9
Delivery: .....	9
Dealer Responsibilities:.....	10
Customer Responsibilities: .....	10
Reporting Safety Defects (USA):.....	10
Reporting Safety Defects (Canada):.....	11
Signalement Des Defauts De Securite A Transport Canada Pour Les Proprietaies Canadiens: .....	11
Tiffin Motorhomes Limited Warranty:.....	12
Warranty Service:.....	12
Owner’s Information Package: .....	12
Customer Relations:.....	13
Safety Messages:.....	13
<b>SAFETY INSTRUCTIONS.....</b>	<b>14</b>
Safety Considerations: .....	15
General Warnings: .....	15
Pre-Departure Checklist: .....	16
Driving Safety:.....	16
Carbon Monoxide Warning:.....	18
CO Detector: .....	18
Fire Safety:.....	20
Fire Extinguisher: .....	20
Smoke Detector: .....	21
Electrical: .....	21
Loading: Refer to towing section .....	21
Maintenance: .....	22
<b>APPLIANCES.....</b>	<b>23</b>
Refrigerator: .....	24

Cooktop:.....	25
Microwave/Air Fryer: .....	25
Air Conditioning System/Heat Pump: .....	26
Water Heater: .....	27
<b>CABINETS &amp; FURNITURE.....</b>	<b>28</b>
Cabinets: .....	29
Counter Tops: .....	29
Stainless Steel Sink with Hide-Away Faucet: .....	30
L-Shaped Sofa with Dinette & Convertible Jackknife Bed: .....	31
Dual Twin Beds/Converts to King:.....	32
<b>CHASSIS FEATURES .....</b>	<b>34</b>
Performance: .....	35
Load Adaptive Electronic Stability:.....	35
Suspension: .....	35
Brakes: .....	36
Tires and Wheels: .....	36
<b>ELECTRICAL FEATURES.....</b>	<b>38</b>
General Information: .....	39
Power Source Transition Procedure:.....	39
Shore Power: .....	40
Batteries: .....	40
Inverter:.....	41
Battery Disconnect Switch: .....	42
120 – VOLT AC (VAC) Receptacles:.....	42
Ground Fault Circuit Interrupt (GFCI) Receptacles:.....	43
Circuit Breakers:.....	43
Firefly Integrations Mira Module: .....	44
Solar Controller: .....	45
Starlink Mini: .....	45
<b>EXTERIOR FEATURES.....</b>	<b>52</b>
Towing Hitch: .....	53

Loading and Towing Tips: .....	53
Vehicle Loading & Weight Guidelines:.....	54
Calculating Vehicle & Load Weights:.....	55
Motion-Sensor Lights in Cargo Bay: .....	55
Running Boards:.....	56
<b>INTERIOR FEATURES.....</b>	<b>57</b>
Flooring: .....	58
Ceiling:.....	58
Window Treatments:.....	59
<b>PLUMBING &amp; BATH FEATURES .....</b>	<b>60</b>
Shower: .....	61
Shower Exhaust Fan: .....	61
Shower Operation:.....	62
Water Pump:.....	63
Sewer Bay: .....	64
Sewer Bay System Overview:.....	65
City Water Connections:.....	65
Run Hot and Cold Fixtures from Fresh Water Tank:.....	66
Sanitizing Hot and Cold Fixtures and Freshwater Tank:.....	66
Sanitizing Hot and Cold Fixtures Only (Not Freshwater Tank):.....	67
Toilet:.....	67
Waste Water Disposal:.....	69
Sewer Connection and Camping:.....	69
<b>AWNINGS, VENTS, AND DOORS .....</b>	<b>71</b>
Windows: .....	72
Power Awning:.....	73
Batwing Awning:.....	74
Vents: .....	75
<b>DRIVING YOUR OPEN TRAIL .....</b>	<b>76</b>
Driving Features:.....	77
Driver and Passenger Seat Controls:.....	78

Driver & Passenger Heated Seats:.....	79
Active Distance Assist: .....	80
Hazard Warning Lights:.....	80
Attention Assist: .....	81
Traffic Sign Assist: .....	81
Active Lane-Keeping Assist:.....	81
High Beam Assist: .....	82
Side View Cameras:.....	82
Audio System:.....	83
Dashboard Climate Control: .....	84
Owl-Ready – Pre-Wired for Always-On Wolfbox Rearview Camera: .....	<b>Error! Bookmark not defined.</b>
<b>MAINTENANCE WASHING AND DRYING .....</b>	<b>86</b>
Washing:.....	87
Seals: .....	87
Proper Sealants For Application:.....	87
Roof Care & Maintenance: .....	88
Moisture Maintenance:.....	88
Interior Care: .....	88
Condensation:.....	88
Fabrics:.....	89
Walls & Ceiling:.....	89
Dashboard: .....	89
Woodwork & Floors: .....	90
Countertops: .....	90
Accessories:.....	90
Detectors:.....	90
Routine Maintenance Schedules:.....	91
Winterizing: .....	92
De-Winterizing: .....	93
Tire & Safety Information:.....	93
Safety First Basic Tire Maintenance:.....	94

Finding Your Van’s Recommended Tire Pressure and Load Limits:	94
Understanding Tire Pressure and Load Limits: .....	94
Checking Tire Pressure: .....	94
Steps For Maintaining Proper Tire Pressure: .....	95
Tire Size: .....	95
Tire Tread: .....	95
Tire Balance and Wheel Alignment: .....	96
Tire Rotation: .....	96
Tire Repair: .....	96
Information on Passenger Tires: .....	96
Vehicle Load Limits: .....	97
Cargo Capacities: .....	97
How Overloading Affects Your Open Trail and Tires: .....	97
Tire Safety Tips: .....	97
Tire Pressure: .....	98
Frequency of Checking Tire Inflation Pressures: .....	98
Tire Wear, Balance, and Wheel Alignment: .....	99
Tire Cleaning: .....	99
<b>MAINTENANCE &amp; DATA CHART .....</b>	<b>100</b>
RV Owner’s Data Sheet: .....	101
RV Owner’s Maintenance Record: .....	102
RV Owner’s Maintenance Record: .....	103
RV Owner’s Maintenance Record: .....	104

# ***OPEN TRAIL***

## GENERAL INFORMATION

---

### Chapter

# 1

## Welcome to a life of “roughing it smoothly”



Tiffin Motorhomes is thrilled to welcome you to the adventure of Open Trail travel, where every journey unfolds into an unforgettable experience. With your Tiffin-built Open Trail, you are stepping into a world of endless possibilities, where comfort meets freedom on the open road. Designed with innovation and reliability in mind, your coach provides all the conveniences of home, allowing you to explore new destinations while enjoying the familiarity of a well-crafted living space. Whether you're embarking on a weekend getaway or a cross-country expedition, the Open Trail is your gateway to spontaneous discoveries and meaningful adventures. As you set forth, know that every mile traveled will weave into a story worth sharing, adding to the

legacy of exploration that defines the Tiffin experience.

Before venturing out on your next great expedition, take the time to explore the Open Trail owner's manual, ensuring you have a thorough understanding of your Open Trail's operations and capabilities. From its innovative features to its seamless functionality, every aspect of your coach is designed to enhance your travel experience. Additionally, working closely with your dealer will provide deeper insights into the specific details of your motorhome, ensuring that you maximize its potential on every journey. Preparation and knowledge are key to a smooth and enjoyable ride, so familiarize yourself with all aspects of your Tiffin-built Open Trail. Then, when the road calls, you'll be ready to answer, equipped with confidence, excitement, and the spirit of adventure that makes every trip uniquely yours. Let the adventure begin!

And remember, **“Wherever you go, we go.”**

### About This Manual:

Carefully read through this manual to understand how everything in your Tiffin Open Trail works.

The instructions included are meant to serve as a guide and in no way extend the responsibilities of Tiffin Motorhomes beyond the standard written warranty. The descriptions, illustrations, and specifications in this manual were correct at the time of printing and Tiffin Motorhomes reserves the right to change specifications or design without notice, and without incurring the obligation to install the same on products previously manufactured.

Many of the instruction sheets and manuals for the various appliances inside your Tiffin Open Trail have been incorporated into this manual for your convenience.

### Delivery:

Throughout the entire manufacturing process, your Tiffin Open Trail has been regularly inspected by our qualified personnel to ensure that you receive the finest product of the highest quality. However, the final inspection at our factory is not the last one. The pre-delivery inspection and system check that your dealer performs are the final inspections before you receive your new Tiffin Open Trail. Your dealer is also available to assist you in understanding the warranties and completing the necessary forms to activate the warranties for the various appliances and accessories installed in your Tiffin Open Trail.

## Dealer Responsibilities:

1. **A pre-delivery inspection and systems check is performed to ensure a thorough inspection of the Tiffin Open Trail and the proper operation of all factory-installed components.**
2. **A customer walk-through is performed to familiarize the buyer with the Tiffin Open Trail, its systems and components, and their proper and safe operation.**
3. **Delivery of the Owner's Information Package, which contains warranty cards and registrations for the vehicle and all factory-installed components from other vendors and suppliers to Tiffin Motorhomes. The detailed operation and maintenance instructions on these components are also included in this package.**
4. **Assisting the customer in completing the registration forms to avoid loss of warranty coverage. The dealer will review the limited-warranty provisions with the customer to stress the importance of completing the warranty cards and registration forms for the components in the Tiffin Open Trail to enable the manufacturers to receive them within the prescribed time limits.**
5. **Providing the customer with information regarding warranty and non-warranty work on the vehicle and its separately warranted components.**

## Customer Responsibilities:

The customer is responsible for regular and proper maintenance of the Tiffin Open Trail. Properly maintaining your Tiffin Open Trail will prevent conditions arising from neglect that are not covered by your Tiffin Motorhomes limited warranty. The maintenance guidelines in this manual and any other applicable manuals must be followed. It is your responsibility and obligation to return the vehicle to an authorized dealer for repairs and service.

To assist you in avoiding problems with your Tiffin Open Trail, Tiffin Motorhomes recommends that you do the following:

1. **Read the warranty. Go over it thoroughly with your dealer to make sure you understand all the terms and conditions of the warranty.**
2. **Inspect the Open Trail; do not accept delivery until you have gone through the motorhome with the authorized Tiffin Motorhomes dealer.**
3. **Ask questions about anything you do not fully understand about your Open Trail. Tiffin Motorhomes is here to serve you and ensure that you have all the information necessary for the safe and enjoyable use of your new Tiffin Open Trail.**
4. **When you are taking delivery, set an appointment for adjustments. This appointment must be within two weeks after you accept delivery.**
5. **You are responsible for using your Tiffin Open Trail in a responsible, safe manner. Take the time to familiarize yourself with the proper operation of the unit before you attempt to use it.**

## Reporting Safety Defects (USA):

575.6(a)(2)(i) At the time a motor vehicle manufactured on or after September 1, 1990, is delivered to the first purchaser for purposes other than resale, the manufacturer shall provide to

the purchaser, in writing in the English language and not less than 10-point type, the following statement in the owner's manual, or. If there is no owner's manuals, on a one-page document:

If you believe that your vehicle has a defect which could cause a crash or could cause injury or death, you should immediately inform the National Highway Traffic Safety Administration (NHTSA) in addition to notifying Tiffin Motorhomes.

If NHTSA receives similar complaints, it may open an investigation, and if it finds that a safety defect exists in a group of vehicles, it may order a recall and remedy campaign. However, NHTSA cannot become involved in individual problems between you, your dealer, or Tiffin Motorhomes.

To contact NHTSA, you may either call the Vehicle Safety Hotline toll-free at 1-888-327-4236 (TTY: 1-800-424-9153); go to <http://www.safercar.gov>; or write to: Administrator, NHTSA, 1200 New Jersey Avenue, S.E., Washington, DC 20590. You can also obtain other information about motor vehicle safety from <http://www.safercar.gov>.

(ii) The manufacturer shall specify in the table of contents of the owner's manual the location of the statement in 575.6(a)(2)(i). The heading in the table of contents shall state "Reporting Safety Defects."

### **Reporting Safety Defects (Canada):**

Vehicles domiciled in Canada that are thought to have a defect that could cause a crash, injury, or death, should immediately be reported to Transport Canada and Tiffin Motorhomes at 1-256-356-8661.

If Transport Canada receives similar complaints, it may open an investigation; if it finds that a safety defect exists in a group of vehicles, it may order a recall and remedy campaign. However, Transport Canada cannot become involved in individual problems between you, your dealer, or Tiffin Motorhomes.

To contact Transport Canada, call the Defect Investigation and Recall Division toll-free in Canada at 1-800-333-0510 or 1-819-994-3328 in the Gatineau-Ottawa area or internationally.

#### **By Mail:**

**Transport Canada – ASFAD  
330 Sparks Street  
Ottawa, ON  
K1A0N5**

### **Signalement Des Defauts De Securite A Transport Canada Pour Les Proprietaires Canadiens:**

Si vous pensez que votre véhicule présente un défaut lié à la sécurité, vous devez immédiatement en informer Transports Canada (TC) ainsi que Tiffin Motorhomes, Inc.

Si Transports Canada reçoit des plaintes similaires, il pourrait ouvrir une enquête à ce sujet. Si le Ministère constate l'existence d'un défaut de sécurité au sein d'un groupe de véhicules, il pourrait ordonner une campagne de rappel et de réparation.

Toutefois, Transports Canada ne peut pas intervenir en cas des problèmes individuels entre vous, votre concessionnaire ou Tiffin Motorhomes, Inc.

Vous pouvez communiquer avec Transports Canada par l'un des moyens suivants:

Par telephone: 819-994-3328 (région de Gatineau-Ottawa ou international)

Numéros sans frais: 1-800-333-0510 (au Canada)

Par la poste:

Transports Canada – ASFAD  
330, rue Sparks  
Ottawa (Ontario)  
K1A 0N5

Vous pouvez également consulter le site Web de Transports Canada à [tc.canada.ca](http://tc.canada.ca) pour remplir en ligne un formulaire de plainte de défauts.

Visit [www.tiffinmotorhomes.com](http://www.tiffinmotorhomes.com) for access to related materials.

## Tiffin Motorhomes Limited Warranty:

The Tiffin Motorhomes limited warranty is provided to you by your authorized Tiffin Motorhomes dealer during the pre-delivery inspection. When you inquire about your Tiffin Motorhomes warranty, refer to this document. If you require an additional copy of the warranty or other information, contact:

Tiffin Motorhomes, Inc.  
105 2nd St. NW • Red Bay, AL 35582  
Phone: 256-356-8661  
Email: [info@tiffinmotorhomes.com](mailto:info@tiffinmotorhomes.com)

Visit [www.tiffinmotorhomes.com](http://www.tiffinmotorhomes.com) for access to related materials.

## Warranty Service:

This Limited Warranty applies exclusively to the Open Trail model and extends for a duration of two (2) years or twenty-four thousand (24,000) miles, whichever occurs first, from the date of purchase by the first retail purchaser. Warranty coverage is expressly limited to specified components and does not include, under any circumstances, coverage for structural integrity or delamination.

To remain eligible for warranty benefits, the purchaser is required to ensure proper use and maintenance of the Tiffin Open Road in accordance with the guidelines provided by Tiffin Motorhomes. This Limited Warranty shall be rendered null and void in the event of misuse, neglect, or any unauthorized alterations or modifications to the product.

In the event that a covered issue arises during the warranty period, the purchaser must promptly contact Tiffin Motorhomes through authorized channels to seek resolution. Claims submitted outside the specified warranty term or for excluded issues, including structural integrity or delamination, will not be honored under the terms of this Limited Warranty.

## Owner's Information Package:

The Owner's Information Package includes valuable documents about your Tiffin Open Trail and its components and systems. By consulting the booklets and instruction manuals included in the Owner's Information Package, you will learn how to operate, maintain, and troubleshoot these

items safely and effectively. The Tiffin Motorhomes Owner’s Manual does not cover every possible detail of equipment—standard and/or optional—installed on or in your vehicle.

As with all valuable documentation, keep them in a safe, secure place for your later use and consultation. When you complete and mail to the respective manufacturers any warranty/guaranty registration cards, make a photocopy of both sides of each card before mailing, and keep the photocopy in your permanent records for your Tiffin Open Trail.

### Customer Relations:

If you wish to schedule maintenance or service, or order parts, you must notify your local authorized Tiffin Motorhomes dealership to set up an appointment. If you are unsure of the location of your nearest authorized Tiffin Motorhomes dealership, access the Tiffin Motorhomes website at [www.tiffinmotorhomes.com](http://www.tiffinmotorhomes.com), and then click on the “Locate Dealer” button, then enter the appropriate search criteria, such as state and retail sales, and then click on the red ball located on the map to find dealer information in that area.

### Safety Messages:

Note that several labels listed in this manual represent items that need your attention. The Danger, Warning, Caution, and Notice labels alert you to precautions that might help you to avoid damage to your Tiffin Open Trail, its equipment, or your personal safety. Read and follow them carefully.

	<b>WARNING</b>
WARNING indicates a hazardous situation, which, if not avoided, could result in death or serious personal injury, or damage to the equipment.	

	<b>CAUTION</b>
CAUTION indicates a hazardous situation, which, if not avoided, could result in minor or moderate personal injury, or damage to the equipment.	

	<b>DANGER</b>
DANGER indicates a hazardous situation, which, if not avoided, will result in death or serious personal injury, and damage to the equipment.	

<b>NOTICE</b>
NOTICE is used to address practices not related to personal injury, or damage to the equipment.

# ***OPEN TRAIL***

## **SAFETY INSTRUCTIONS**

---

### **Chapter**

# **2**

## Safety Considerations:

Before using your Tiffin Open Tail, especially for the first time or after a long period of non-use, read all the instructions in the Owner's Manual and the chassis-manufacturer's manual thoroughly. There are several safety considerations that you must be aware of and follow while your Open Trail is in motion. These safety considerations, as well as others meant to preclude any damage to the motorhome, are listed in this chapter. Besides the driver, it would be helpful for the passengers to be familiar with these safety considerations and precautions too.

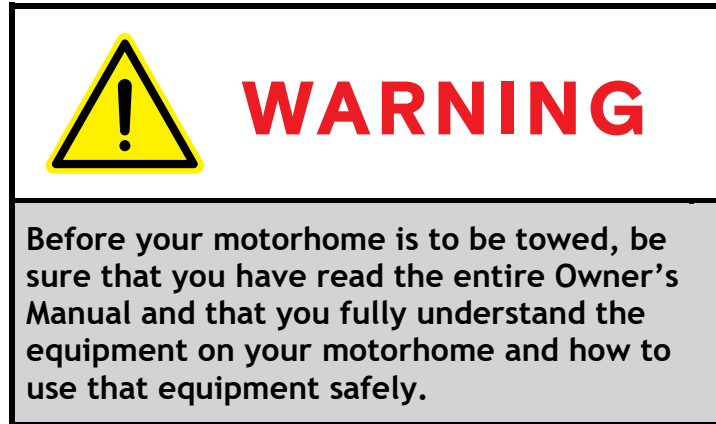

## General Warnings:

In general, several "common-sense" safety precautions must be taken every time the Tiffin Open Trail is to be used on the road. These precautions include:

- Only seats with seat belts must be used while the motorhome is in motion; the seat belts should be worn by all people (driver and passengers) in the motorhome at that time.
- While the motorhome is moving, lock all seats in the forward-facing position to provide maximum safety for the users.
- While the motorhome is moving, no one (e.g., young children) inside should ever stand or kneel on the seats.
- In most states, it is the law that seat belts must be used (fastened snugly about the chest and hip areas) anytime the motorhome is in motion, to provide desired protection in the event of a crash.
- Any fire extinguishers must be inspected monthly to ensure that each extinguisher is properly charged and ready for operation.
- Any smoke and/or carbon monoxide (CO)/liquid propane (LP) alarms must be regularly inspected and tested. If being used for the first time, the smoke and/or CO alarm must be properly activated and fresh batteries installed before the motorhome is placed into service. Never sleep in a motorhome not having functional smoke and/or CO alarms.
- While the motorhome is moving, the sleeping facilities are not to be used.
- Never leave the driver's seat unattended while the motorhome is in motion.

## Pre-Departure Checklist:

For your continued safety and convenience, the following is a representative “checklist” designed to ensure your safety while driving:

- ✓ Clean all windows, mirrors, and light lenses (front, back, and sides) to ensure that you can “see” and “be seen.”
- ✓ Reposition any mirrors or other fixtures to provide an unobstructed view (front, back, and sides) from the driver’s seat.
- ✓ Remove or secure all loose fixtures (e.g., awnings, flags, antennas, portable lights) to keep them from falling from the motorhome when the vehicle is in motion.
- ✓ Make a “walk-around” visual inspection of the motorhome to note any irregularities (e.g., loose trim) or problems (e.g., low tires), correct noted problems accordingly.
- ✓ Check all exterior storage-compartment doors to make sure they are properly latched. If need be, check inside all exterior compartments to make sure that all cargo and equipment are properly secured so that they do not work loose and become hazards during sudden starts and stops.
- ✓ Check the tires for proper inflation (i.e., cold-inflation pressure: 50 psi). If the Tiffin Open Trail has not been used recently, make sure that the “cold inflation” pressure is maintained. If the motorhome has recently been used, make sure that the “hot inflation” pressure (see the tire-manufacturer’s literature to determine appropriate “hot inflation” pressure) is maintained on each axle. Not all axles require the same tire pressure.
- ✓ Examine wheel lug nuts to ensure their proper tightness. If any lug nuts are found to be loose, first check the fit of the wheel to the hub to make sure the wheel is mounted properly, which would produce a “wobbly” wheel when the motorhome is in motion and then tighten the lug nuts.
- ✓ Check all fluid levels (e.g., engine oil, transmission fluid, coolant, power-steering fluid, brake fluid, battery fluid [if applicable], windshield-washer solvent) to ensure that correct levels are maintained. Fill any low reservoirs, as needed.
- ✓ DO NOT SUBSTITUTE any other fluids for specified oils, transmission fluid, brake fluid, or other hydraulic fluids—substitutions are not acceptable and can void warranties.
- ✓ Before starting the Open Trail engine, make sure all lines (e.g., water, sewer) and electrical power cords are disconnected and properly stowed.
- ✓ Check all interior doors (e.g., shower, microwave, refrigerator, etc.) to ensure that they are locked and/or secure. Make sure that all large items are stored away and secure (e.g., coffee pots, corning ware, etc.).



## Driving Safety:

Various adjustments must be made to ensure the driver’s comfort and the safety of the motorhome before starting and moving the motorhome; these include:

- Do not attempt to adjust the driver’s seat while the vehicle is moving.

- Do not adjust the tilt steering while the vehicle is moving.
- The driver must be familiar with all gauges, instruments, switches, and indicators on the instrument panel (Figure 2-1) before driving.
- Do not operate the cruise-control function during any extreme weather situations (e.g., snow, ice, sleet, heavy rain), when road conditions are hazardous (icy, snowy, winding roads, city traffic), when a constant speed of the Open Trail is not possible, or if traffic conditions do not warrant such.
- Avoid driving the motorhome through any standing water. If deep enough, such water can wet the brake pads and cause fading of the brakes (i.e., loss of braking power) and lead to excessive sliding or pulling to one side or the other.



Figure 2-1: Driver Instrument Panel

	CAUTION
<p><b>DO NOT overextend either shade as this might block the view of the road.</b></p>	

- NEVER use any other “burning” equipment (e.g., charcoal grills, wood stoves, butane lights, propane lights) inside the motorhome. Doing so might cause fires and/or asphyxiation.

	WARNING
<p><b>Any portable, fuel-burning equipment (e.g., charcoal, propane, butane, wood) must not be used inside the motorhome. Any use of such equipment inside the motorhome might readily cause fires and/or asphyxiation by carbon-monoxide poisoning. Moreover, such unauthorized use will probably invalidate your motorhome insurance policy.</b></p>	

## Carbon Monoxide Warning:

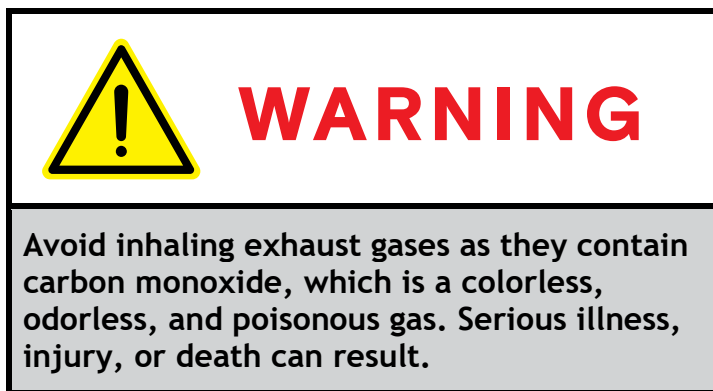

A properly maintained engine exhaust and ventilation system is the best way to protect against carbon monoxide's entry into the vehicle. Tiffin Motorhomes recommends that the exhaust system and body be inspected by a qualified Tiffin Motorhome service center:

- Each time the vehicle is serviced for an oil change.
- Whenever a change in the sound of the exhaust system is noticed.
- Whenever the exhaust system, underbody, or rear of the vehicle is damaged.

To allow proper operation of the vehicle's ventilation system, always keep the front ventilation inlet grill clear of obstructions.

Do not occupy a parked vehicle with the engine running for an extended time, and do not run the engine in confined areas, such as a garage.

Your motorhome is equipped with a combination CO/Gas Alarm (Figure 2-2). This alarm combines a single compact system that detects both Carbon Monoxide (CO) and Propane (LPG) gas. It will detect carbon monoxide gas from any combustion source such as from the furnace, oven/range, water heater, refrigerator, chassis engine, and generator engine.

### CO Detector:

To activate the CO sensor on this detector for the first time, remove the sensor activation strip, if it was not removed during the pre-delivery inspection.

If the alarm persists in re-arming and giving further alarms, ventilate the motorhome by opening the doors and windows. If the leak cannot be readily found after the ventilation process is concluded, then take the motorhome to a qualified service technician.

The CO detector is a powerful combined alarm that detects Carbon Monoxide (CO)). This detector uses the latest microprocessor technology combined with two electronic self-cleaning sensors that operate independently of each other. The combined unit can detect both CO and explosive gases simultaneously.

Carbon monoxide (CO) is a colorless, odorless, tasteless gas, which, when breathed, bonds to the hemoglobin in the red blood cells and, thus, drastically reduces or blocks the transfer of oxygen from the lungs to the rest of the body.

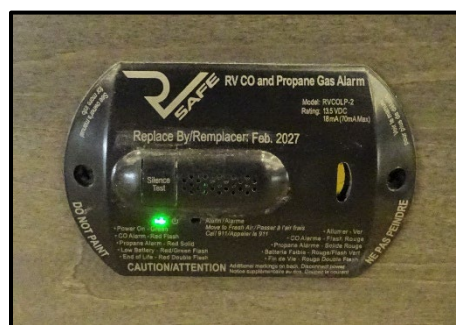

Figure 2-2: CO Detector

In sufficient concentrations, CO kills by asphyxiation. In lesser amounts, CO makes the victim groggy, lethargic, and unable to think clearly or quickly.

CO is one of the products of combustion for many materials including petroleum-based products (e.g., gasoline, diesel fuel, propane, butane, etc.). Since many of the appliances and the engines associated with the motorhome produce CO in their normal operations, it is necessary to ensure that CO levels do not rise to dangerous levels within the motorhome. In sufficiently high concentrations, CO can kill in minutes.

The people most susceptible to CO poisoning are unborn babies, small children, pregnant women, senior citizens, and people with cardiovascular or respiratory problems.

Consequently, it is prudent to check the CO monitor regularly for normal operation and to remain aware of the symptoms of CO poisoning, which include dizziness, nausea, vomiting, muscular twitching, throbbing in the temples, incoherent thinking and speech, weakness, sleepiness, and intense headaches.

If any of these symptoms are experienced in the motorhome, IMMEDIATELY evacuate the motorhome and seek medical help. Shut down the motorhome and do not attempt to operate it again until the sources of the CO are located and fixed.



**DANGER**

**Carbon monoxide gas—derived from products of combustion of diesel fuel, and other petroleum-based products—is a deadly gas that can kill motorhome occupants, if allowed to accumulate in sufficient concentration. Ensure that all engine operations are not restricted tailpipes and exhaust ports should not be blocked or restricted in any way. Additionally, any accumulation of exhaust gases outside or underneath the vehicle must be avoided as it might enter the motorhome through windows or vents—be careful of how and where the motorhome is parked to avoid such conditions. Regularly monitor outside conditions to ensure that all exhaust gases can readily be dissipated and not enter the motorhome inadvertently.**



## DANGER

Never sleep in a Van when the engine is running—engine exhaust fumes could enter the Van and cause disability or death. Regularly check the exhaust system to note any leakage sites and, if found, discontinue use of the Van until they are repaired by a competent, qualified service technician. Do not attempt repairs on the exhaust system yourself and do not modify (temporarily or permanently) the exhaust system at all.

### Fire Safety:

As with any enclosed system containing the three required conditions for fire (i.e., combustible materials, oxygen, and ignition sources), there will exist the possibility of fire inside the motorhome. Tiffin Motorhomes has taken every precaution and design practice to minimize or negate this possibility, but the final determination rests with the owner and user of the motorhome. Hence, the owners, users, and their guests must be aware of basic fire-safety practices and procedures, and those features that Tiffin Motorhomes has provided for fire safety.

### Fire Extinguisher:

The Tiffin Open Trail is equipped with a fire extinguisher (Figure 2-3) located in the entrance door stairwell. The extinguisher is rated for both Class B (i.e., grease, gasoline, diesel fuel, flammable liquids) and Class C (i.e., electrical) services.

Read and understand the accompanying owner's manual on the extinguisher (found in your Owner's Information Package) and remember the location of the extinguisher. These types of fire extinguishers are pressurized mechanical devices and require that appropriate care be used in their safe storage and use. The owner's manual will provide necessary guidance for the proper storage, handling, and use of the extinguishers.

Prudent preventive maintenance suggests monthly inspection of any fire extinguisher to ensure that it is sufficiently pressurized (i.e., the needle on the gauge is in the "normal" zone) and that the mechanical components are not blocked in any way.

**DO NOT test a fire extinguisher by partially discharging the unit**—this will cause a loss of pressure and might lodge some fire-retardant materials in the valve mechanism and cause the extinguisher to continue to vent slowly down to zero pressure. If an extinguisher is ever partially used, continue its use until the unit is completely discharged. Then, have the fire extinguisher fully recharged at an appropriate service center (call any fire department for information on having an extinguisher recharged in that locality).



Figure 2-3: Fire Extinguisher

**DO NOT** wait to recharge an empty fire extinguisher; you will never know when it might be needed.

Should a fire occur inside or around the motorhome, evacuate the motorhome quickly and calmly—do not panic. In the event of heavy smoke or extensive flames, keep low (crawl if you must), and make your way to the nearest exit (door, emergency window) and leave. If the fire involves a fuel source (e.g., diesel fuel, LP gas), consider the probability of an explosion and move sufficiently far away to minimize personal harm. If possible, immediately place a call to the local fire department (or ask someone nearby to do so) to report the fire. Consider the cause and the consequences of the fire and the risks associated with possibly fighting the fire yourself before trying to extinguish it.

**DO NOT** expose yourself or others to unnecessary danger.

## Smoke Detector:

The Tiffin Open Trail is equipped with a battery-operated smoke detector (Figure 2-4) located on the ceiling in the living area of the motorhome.

The smoke detector must be tested on a weekly basis, before each trip, and after any period of storage of the motorhome.

If a low-battery condition is noted or the alarm “chirps” to indicate a low-battery condition, immediately replace the battery. Tiffin Motorhomes recommends that you keep replacement batteries in the motorhome for any in-transit replacements so that the smoke-alarm capability is never compromised.

**DO NOT disable the smoke detector** for any transient, false alarm (e.g., cooking smoke, dusty furnace, tobacco smoke). Ventilate the motorhome with fresh air and the alarm will reset on its own.

## Electrical:

- Careless handling of electrical components can be fatal. Never touch or use electrical components or appliances while feet are bare, hands are wet or standing in water.
- Improper grounding of the vehicle can cause personal injury.
- Do not attach an extension cord to the utility power cord.
- Do not use any electrical device that has had the ground pin removed.
- Avoid overloading electrical circuits. Replace fuses or circuit breakers with those of the same size and amperage rating only. NEVER use a higher rated fuse or breaker.

## Loading: Refer to towing section

- Store or secure all loose items inside the motorhome before traveling. Possible overlooked items such as canned goods or small appliances on the countertop, or freestanding furniture can become dangerous projectiles during a sudden stop.
- Be aware of GVWR, GAWR, and individual load limit on each tire or set of duals.
- Never load the motorhome in excess of the gross vehicle weight rating or the gross axle weight rating for either axle.



Figure 2-4: Smoke Detector

## Maintenance:

- Do not remove the radiator cap while the engine and radiator are still hot. Always check the coolant level visually using the see-through coolant reservoir.
- NEVER get beneath a vehicle that is held up by a jack only.
- Do not mix different construction types of tires on the vehicle. Replace tires with the exact size, type, and load range.

# ***OPEN TRAIL***

## APPLIANCES

---

### Chapter

# 3

## Refrigerator:

The Tiffin Open Trail is equipped with a Dometic 10.5 cu. ft. refrigerator (Figure 3-1), designed for convenience and versatility. Its spacious interior provides ample storage for perishables, ensuring you have everything you need for your journey. With efficient cooling performance, this refrigerator maintains optimal temperatures while operating solely on electric power, offering reliability whether you're parked or on the move.

Before using your new refrigerator for the first time, it is essential to prepare it properly to ensure optimal performance and hygiene. Begin by thoroughly cleaning both the interior and exterior with a damp cloth. This step helps remove any residual manufacturing dust and ensures a sanitary environment for your stored food items. A clean refrigerator not only maintains food quality but also prevents any unwanted odors from developing.

Several factors can influence the cooling efficiency of your refrigerator. The ambient temperature, especially when the vehicle is exposed to direct sunlight, plays a significant role in determining how quickly the unit reaches its optimal cooling level. Additionally, the amount of food being stored and the frequency of door openings can impact the refrigerator's ability to maintain consistent temperatures. Keeping these factors in mind will help ensure efficient operation and food preservation.

When using the refrigerator for the first time, you might notice a mild odor, which is completely normal. This scent will dissipate after a few hours, especially if the living space is well-ventilated. Ensuring proper airflow around the refrigerator can further enhance its cooling ability. Additionally, before setting off on your journey, it's crucial to park your vehicle on a level surface, particularly when first filling the refrigerator. This step helps the cooling system function correctly and stabilizes the temperature distribution throughout the unit.

Once the refrigerator is switched on, the freezer compartment should begin cooling within approximately an hour. However, it may take a few hours for the refrigerator to reach its optimal operating temperature. To allow the system to stabilize and perform efficiently, avoid storing food items in the refrigerator for the first 12 hours. Following these guidelines will help ensure that your refrigerator operates smoothly, keeping your perishables fresh and ready for your travels.

### Operating the Refrigerator

#### Turning the Refrigerator On:

- Press and hold the control knob for 2 seconds.
- The refrigerator will start using the most recent settings.

#### Switching Off the Refrigerator:

- Press and hold the control knob for 4 seconds.
- A beep sound will indicate that the refrigerator has switched off.



Figure 3-1: Dometic Refrigerator



Figure 3-2: Control Knob

## Cooktop:

The TIFFIN Open Trail comes equipped with a powerful single-burner induction cooktop (Figure 3-3), bringing effortless precision and efficiency to your cooking experience.

To use a single burner induction cooktop effectively, begin by placing induction-compatible cookware with a ferrous base on the cooktop surface. Since induction technology utilizes electromagnetic energy to directly heat the cookware rather than the cooktop itself, it is essential to use pots and pans specifically designed for induction cooking. Once the cookware is positioned, activate the cooktop and select the desired temperature or power level using the control panel. The cooking process is precise and efficient, ensuring rapid heating and energy conservation.



Figure 3-3: Induction Cooktop

After use, allow the cooktop to cool before proceeding with cleaning. To maintain its functionality and appearance, wipe the smooth glass surface with a soft, damp cloth or sponge to remove spills and residue. For more stubborn stains, apply a mild cleaning solution or a mixture of vinegar and baking soda. Avoid using abrasive materials that could scratch the surface. Lastly, ensure the cooktop is thoroughly dried before storage or further use to preserve its sleek design and optimal performance.

## Microwave/Air Fryer:

The Tiffin Open Trail features a 1.1 Cu. Ft. Convection SMART AIR-FRY Built-in Microwave (Figure 3-4) in stainless steel, designed for efficient and versatile cooking. This microwave combines convection cooking with air-frying technology, allowing users to bake, broil, roast, reheat, and grill with precision. The SMART Air-Fry function rapidly circulates hot air around food, achieving a crispy, golden-brown finish without the need for excess oil.

### Control Panel Overview

The microwave features an LED display (Figure 3-5) with touch-sensitive buttons for easy navigation. Below are the key buttons and their functions:

#### 1. **Power Level Button**

Adjusts the microwave's power settings.

Choose from 10 adjustable power levels for different cooking needs.

#### 2. **Air-Fry Button**

Activates the SMART Air-Fry function.

Rapidly circulates hot air to crisp food without excess oil.

#### 3. **Convection Cooking Button**

Enables convection mode for baking, broiling, roasting, and grilling.



Figure 3-4: Convection Smart Air-Fry Microwave

Uses a fan to distribute heat evenly.

#### 4. **One-Touch Cooking Menus**

9 pre-programmed cooking options for common foods.

Examples: popcorn, pizza, vegetables, and beverages.

#### 5. **Express Cooking Button**

Quickly reheats food with a single press.

Ideal for warming leftovers.

#### 6. **Defrost Button**

Time, Weight & Auto Defrost options.

Automatically calculates the best defrosting time based on food weight.

#### 7. **Start/+30 Sec Button**

Begins cooking or adds 30 seconds to the current cycle.

#### 8. **Stop/Clear Button**

Cancels the current operation or clears settings.

#### 9. **Timer Button**

Sets a countdown timer for cooking or reminders.

#### 10. **Turntable On/Off Button**

Controls the 12.5-inch glass turntable for even heating.



Figure 3-5: LED Display

---

Note: Appliances and equipment may vary across Tiffin Open Trail units. Specific features depend on the model, floor plan, and appliances available at the time of the build.

---

## Air Conditioning System/Heat Pump:

The Tiffin Open Trail is equipped with the 15,000 BTU Gree Eco-Cool Air Conditioner with Heat Pump, designed for efficient climate control in all seasons. This advanced system provides both cooling and heating capabilities, ensuring a comfortable interior environment regardless of external conditions. The soft-start feature reduces initial power draw, making it compatible with shore power, generators, and inverters. Users can conveniently adjust temperature settings, fan speeds, and operational modes via the digital control panel or Bluetooth connectivity, allowing for remote management through the Gree mobile app. The heat pump function efficiently transfers ambient heat to maintain warmth in colder temperatures without relying solely on electric resistance heating, optimizing energy consumption. To maximize performance, ensure regular filter maintenance and proper airflow distribution throughout the vehicle. For detailed operational instructions, troubleshooting and maintenance guidelines, refer to the full owner's manual in the Owner's Information Package.

Operating Your Gree Eco-Cool Air Conditioner

1. **Power On** – Use the control panel (Figure 2-5) or Bluetooth app to turn on the unit.
2. **Mode Selection** – Choose between cooling, heating, fan, or dehumidifier.

3. **Soft-Start Feature** – This helps reduce the initial power surge, making it generator-friendly.
4. **Temperature Control** – Set your desired temperature via the remote or app.
5. **Fan Speed** – Adjust airflow for comfort.
6. **Bluetooth Connectivity** – Use the mobile app for remote control.

## Water Heater:

The TIFFIN Open Trail is equipped with the state-of-the-art hydronic system, designed to provide a continuous and efficient supply of hot water. Maintaining a precise temperature range of 110°F to 120°F, this advanced system ensures optimal comfort for daily use. With a flow rate of 0.8 gallons per minute, it delivers reliable performance for both kitchen applications and showering, catering to a variety of your van life needs. Whether washing dishes or enjoying a warm and refreshing shower, users can rely on the hydronic system for consistent and dependable hot water delivery. Engineered for efficiency, this system minimizes energy consumption while maximizing convenience, making it an ideal addition to the TIFFIN Open Trail's innovative design.



Figure 2-5: Gree Eco-Cool Control

# ***OPEN TRAIL***

## **CABINETS & FURNITURE**

---

### **Chapter**

# **4**

## Cabinets:

The Tiffin Open Trail features black powder-coated cabinetry with composite trim (Figure 4-1), combining durability and modern aesthetics for a refined interior. The powder coating process enhances the cabinetry's resistance to scratches, corrosion, and daily wear, ensuring long-term reliability in the demanding environment of an RV. The composite trim adds a lightweight yet sturdy element, preventing warping and moisture damage while maintaining a sleek, professional finish. Together, these materials create a stylish and functional space that requires minimal maintenance, making it an excellent choice for those seeking both luxury and practicality on the road.

### Materials & Construction

- **Powder-Coated Finish** – The cabinetry is coated with a black powder finish, which is applied electrostatically and cured under heat. This process creates a durable, scratch-resistant surface.
- **Composite Trim** – The trim is made from lightweight composite materials, designed to resist moisture, warping, and wear over time.

### Maintenance & Cleaning

- **Cleaning the Powder-Coated Surface** – Use a soft cloth with mild soap and water. Avoid abrasive cleaners that could damage the finish.
- **Composite Trim Care** – Wipe with a damp cloth; for tougher stains, use a non-abrasive cleaner.

## Counter Tops:

The Tiffin Open Trail features solid surface countertops (Figure 4-2), designed for durability and a refined aesthetic. To further enhance functionality, it incorporates a countertop extension, providing additional workspace while integrating convenient storage for the cooktop. This intelligent design ensures an efficient and organized kitchen environment, optimizing both practicality and space within the vehicle.

Cleaning solid surface countertops is straightforward and requires minimal effort to maintain their appearance and durability. Here are some best practices:

- **Daily Cleaning:** Use warm soapy water and a soft cloth to wipe down the surface, removing dirt and grease.
- **Stain Removal:** For tougher stains, apply an ammonia-based cleaner, let it sit for a couple of minutes, and then wipe it away.
- **Disinfection:** Occasionally, use a diluted bleach solution (5 tablespoons of bleach per gallon of water) to disinfect the surface.



Figure 4-1: Open Trail Cabinets



Figure 4-2: Solid Surface Countertops

- **Avoid Harsh Chemicals:** Do not use strong acidic or alkaline cleaners, as they can damage the finish.
- **Prevent Scratches:** Use a microfiber cloth instead of abrasive pads and avoid cutting directly on the surface.
- **Heat Protection:** Do not place hot pans or appliances directly on the countertop; use trivets or heat-resistant pads.

## Stainless Steel Sink with Hide-Away Faucet:

The Tiffin Open Trail is equipped with a stainless-steel sink featuring a hide-away faucet (Figure 4-3), designed for durability, convenience, and space efficiency. The stainless-steel construction ensures resistance to corrosion and stains, while the hide-away faucet provides a streamlined look when not in use.

### Operation (Figure 4-4)

1. **Deploying the Faucet** – Lift the faucet from its recessed position and extend it to the desired height and angle.
2. **Adjusting Water Flow** – Turn the control knob to regulate water pressure and temperature.
3. **Retracting the Faucet** – After use, lower the faucet back into its designated compartment for a clean, unobtrusive appearance.

### Maintenance

- **Cleaning** – Wipe the sink and faucet with a soft cloth and mild detergent. Avoid abrasive cleaners that may damage the finish.
- **Water Flow Check** – Periodically inspect the faucet for blockages and ensure smooth operation.
- **Seal Inspection** – Check for leaks around the faucet base and tighten connections if necessary.



Figure 4-3: Stainless-Steel Sink



Figure 4-4: Faucet and Control Knob

## L-Shaped Sofa with Dinette & Convertible Jackknife Bed:

The Tiffin Open Trail is designed with versatility and comfort in mind, offering two distinct seating configurations to accommodate various needs: the standard L-shaped sofa/dinette and the optional convertible jackknife sofa.

### L-Shaped Sofa/Dinette (Standard)

The L-shaped sofa/dinette (Figure 4-5), serves as a multifunctional space, seamlessly transitioning between a comfortable lounge area and a functional dining setup. The L-Shape extension allows for additional seating, while the adjustable cushions provide ergonomic support. When converting the dinette into a sleeping space, the dinette table can be lowered to its lowest position, and the cushions can be rearranged to form a flat, supportive surface. This configuration is ideal for maximizing space efficiency while maintaining a stylish and practical interior.



Figure 4-5: L-Shaped Sofa/Dinette

### Convertible Jackknife Sofa Bed (Optional)

For those seeking an alternative seating arrangement, the jackknife sofa (Figure 4-6) is available as an upgrade. This design features a streamlined folding mechanism that allows the sofa to convert into a bed with a simple pull-and-lay motion. The jackknife sofa is engineered for ease of use, offering a quick transition between seating and sleeping configurations without requiring complex adjustments. Its compact design makes it an excellent choice for those prioritizing space-saving solutions while maintaining comfort.



Figure 4-6: Jackknife Sofa

Maintaining the softness and cleanliness of your Tiffin Open Trail sofa ensures both comfort and durability.

1. **Dust & Wipe** – Use a dry microfiber cloth to remove surface dust.
2. **Prepare a Cleaning Solution** – Mix warm water with mild dish soap. Avoid harsh chemicals.
3. **Gentle Scrubbing** – Use a cloth to clean the vinyl in circular motions.
4. **Rinse & Wipe** – Dampen a clean cloth with water and wipe away soap residue.
5. **Dry Thoroughly** – Pat the sofa dry with a towel to prevent moisture buildup.
6. **Treat Stains Carefully** – For stubborn stains, use vinyl-safe cleaner.
7. **Avoid Harsh Products** – Never use ammonia-based cleaners or abrasive scrubbers, as they can damage the vinyl.

To keep your vinyl sofa soft and supple over time, follow these maintenance tips:

1. **Regular Cleaning** – Wipe down the surface with mild soap and water to prevent dirt buildup.

2. **Conditioning** – Apply a vinyl conditioner occasionally to maintain flexibility and prevent cracking.
3. **Avoid Harsh Chemicals** – Stay away from bleach, ammonia, and acetone, as they can dry out and damage the material.
4. **Protect from Sunlight** – Prolonged exposure to direct sunlight can cause fading and stiffness. Use UV-protective covers or position the sofa away from windows.
5. **Prevent Stains** – Clean spills immediately to avoid discoloration and hardening of the vinyl.
6. **Temperature Control** – Keep the sofa in a moderate temperature environment, as extreme heat or cold can make vinyl brittle.

## Dual Twin Beds/Converts to King:

The Tiffin Open Trail is thoughtfully designed to provide maximum versatility and comfort, featuring twin beds that can seamlessly convert into a king-size bed (Figure 4-7). This adaptable sleeping arrangement allows users to customize their space based on their preferences, whether they prefer separate twin beds for individual sleeping or a spacious king bed for a more expansive rest area.

Each twin bed is equipped with built-in cup holders (Figure 4-8), adding convenience for nighttime relaxation, whether enjoying a beverage, reading, or watching television. When converting the twin beds into a king-size bed, users simply insert the three cushions stored at the rear of the coach into the center space, creating a secure mount that ensures stability and comfort. The transition is designed to be effortless, allowing for quick adjustments without complicated mechanisms.

For easy access to the king bed, a ladder is provided, which latches onto the last bed insert, ensuring a sturdy and reliable entry point. This design enhances convenience, allowing users to climb into the sleeping area with ease while maintaining a secure setup.



Figure 4-7: Dual Twin Beds/Convert to King Bed



Figure 4-8: Built in Cup Holders

### Step-by-Step Cushion Placement (Figure 4-9)

1. **Position Cushion #1** – Take Cushion #1 and place it into the first center insert below window, ensuring it sits flush with the twin bed sections.
2. **Position Cushion #2** – Move Cushion #2 into the second center insert, aligning it securely with Cushion #1.
3. **Flip and Place Cushion #3** – Rotate Cushion #3 so that the ladder hangers are facing outward. Insert the cushion into the third center insert, ensuring a stable mount.

### Final Adjustments

- **Check Alignment** – Ensure all cushions are properly positioned and secured.
- **Verify Stability** – Press down on the cushions to confirm a firm sleeping surface.
- **Attach Ladder** – Secure the ladder hangers onto Cushion #3 for easy access to the king bed (Figure 4-10).



Figure 4-9: Step-by-Step Cushion Placement



Figure 4-10:  
Ladder

# ***OPEN TRAIL***

## **CHASSIS FEATURES**

---

### **Chapter**

# **5**

## Performance:

The Tiffin Open Trail Mercedes-Benz® 3500XD AWD Dual Wheel is built for durability, performance, and comfort, offering a powerful driving experience. Featuring a Mercedes-Benz® 2.0 Liter I4 Turbo Diesel High Output Engine, this chassis delivers 208 HP and 332 lb-ft of torque, ensuring smooth acceleration and efficient performance. The Mercedes-Benz® 9G-Tronic Automatic Transmission enhances driving precision, while All-Wheel Drive provides stability and control in various road conditions. Additionally, a 220-Amp Alternator ensures consistent electrical power supply.

## Load Adaptive Electronic Stability:

Load-Adaptive Electronic Stability Program (ESP) in the Mercedes-Benz 3500XD AWD helps maintain vehicle stability by adjusting braking and engine power based on load conditions. Here's how it operates:

1. **Automatic Activation:** The system is always active when driving and continuously monitors vehicle dynamics.
2. **Load Detection:** Sensors assess the vehicle's weight distribution and adjust stability controls accordingly.
3. **Braking Adjustments:** If the system detects potential skidding or loss of control, it selectively applies brakes to individual wheels to stabilize the vehicle.
4. **Engine Power Management:** ESP can reduce engine power momentarily to prevent excessive wheel spin.
5. **Cornering Stability:** The system helps maintain control when navigating curves, especially with heavy loads.
6. **Limitations:** While ESP enhances stability, it does not replace careful driving, especially in extreme weather or road conditions.

## Suspension:

The Sumo Springs® rear suspension is a key enhancement designed to improve the ride quality of the Tiffin Open Trail Mercedes-Benz® 3500XD AWD. These suspension components function as progressive-rate airless springs, providing additional support to the rear suspension system. Their primary benefits include improved handling, greater stability, and enhanced comfort, particularly when driving over uneven terrain or rough roads. The Sumo Springs® work by reducing sway and absorbing vibrations, creating a smoother driving experience with less fatigue for the driver and passengers.

Additionally, these springs help mitigate excessive chassis movement, enhancing overall control when navigating curves, bumps, and dips. This improved damping effect reduces strain on the vehicle's suspension components, leading to less wear and tear over time. The Sumo Springs® are particularly beneficial for vehicles carrying heavy loads or those frequently used for long-distance travel.

The Tiffin Open Trail offers the Agile RIP (Ride Improvement Package) Kit as an optional upgrade, providing an enhanced suspension system tailored for smoother handling and greater ride comfort. This package replaces the Sumo Springs®, refining the chassis' ride quality with custom-tuned shock absorbers and upgraded suspension components.

The Agile RIP Kit is designed to improve stability, control, and road feedback, particularly beneficial for off-road driving or long-distance travel. It optimizes suspension travel, enhances damping efficiency, and reduces harsh impacts on rough terrain. This option caters to drivers looking for a more dynamic and responsive driving experience, fine-tuned for comfort without sacrificing performance.

## Brakes:

The Tiffin Open Trail is built on the Mercedes-Benz 3500XD AWD chassis, which includes Active Brake Assist (also known as Collision Mitigation). This system enhances safety by detecting obstacles ahead and automatically applying braking if a collision is imminent.

### How Active Brake Assist Works

- Uses radar and camera sensors to monitor traffic.
- Provides visual and acoustic warnings if a potential collision is detected.
- If the driver does not react, the system automatically applies braking to reduce impact or avoid the collision.

### Additional Safety Features

- Integrated with Adaptive Cruise Control, allowing smooth speed adjustments based on traffic flow.
- Helps prevent rear-end collisions by reacting to sudden stops or obstacles.

### Steps to Adjust Active Brake Assist

1. **Access the Settings Menu:**
2. **Navigate to the MBUX infotainment system.**
3. **Select Vehicle Settings and then Driver Assistance.**
4. **Modify Sensitivity:**
5. **Choose between Early, Medium, or Late intervention levels.**
6. **This determines how soon the system reacts to potential collisions.**
7. **Enable or Disable Warnings:**
8. **You can toggle visual and acoustic alerts on or off.**
9. **Deactivate the System (Not Recommended):**

If needed, you can turn off Active Brake Assist, but it will reactivate upon restarting the vehicle.

## Tires and Wheels:

The Tiffin Open Trail is designed for durability and superior performance, outfitted with reliable components that ensure smooth and secure travel. It sits on four LT245/70 R17 BF Goodrich all-terrain T/A KO2 tires, renowned for their rugged design and traction in diverse environments, from highways to challenging off-road terrains. Complementing these tires are high-quality custom Tiffin Adventure black alloy off-road wheels (Figure 5-1), which not only enhance the vehicle's stability but also add a stylish touch to its appearance. This combination makes the Tiffin Open Trail a dependable choice for adventures that demand robust and versatile equipment.

To keep your custom adventure off-road wheels in top condition, follow these cleaning and maintenance steps:

**1. Regular Cleaning:**

- Start by rinsing the wheels with water to remove loose dirt and debris. This prevents scratches during cleaning.
- Apply a pH-balanced wheel cleaner or degreaser suitable for your wheel's finish. Avoid harsh chemicals that can damage the surface.
- Use a soft-bristle brush to gently scrub the wheels, paying attention to intricate areas and crevices.
- Rinse thoroughly to remove all traces of cleaner and loosened dirt.
- Dry the wheels completely with a clean microfiber cloth to prevent water spots.



Figure 5-1: Tires and Wheels

**2. Deep Cleaning:**

- For a thorough clean, consider removing the wheels from your vehicle. This allows access to the back side of the wheels and wheel wells.
- Follow the regular cleaning steps for the face and barrels of the wheels. If dismounted, clean the back of the wheels and spokes as well.
- Use an iron remover to break down brake dust and other contaminants during deep cleaning.

**3. Protection:**

- Apply a high-quality wax, sealant, or ceramic coating to protect the finish. This creates a barrier against brake dust, road grime, and other contaminants.
- Avoid using acidic or alkaline cleaners, as they can harm the wheel's finish. Stick to pH-balanced products designed for wheels.

**4. Maintenance:**

- Inspect the wheels regularly for signs of damage or wear. Address any issues promptly to maintain their integrity.
- Clean the wheels frequently to prevent the buildup of brake dust and grime, preserving their appearance and extending their lifespan.

By following these steps, your wheels will remain in excellent condition, ensuring both aesthetics and performance for years to come.

# ***OPEN TRAIL***

## **ELECTRICAL FEATURES**

---

### **Chapter**

# **6**

## General Information:

There are two electrical systems in your Tiffin Open Trail. These are the 12-volt DC (VDC) system and the 120-volt AC (VAC) system. Most standard appliances require the 120-VAC system, while the majority of the lighting systems used in the Tiffin Open Trail use the 12-VDC electrical system.

The house battery bank is charged by the 30A shore power plug running through the inverter charger. The auxiliary alternator also charges the batteries when the engine is running.

The electrical power for the 120 VAC is supplied by the 30 AMP shore power cord when the Tiffin Open trail is connected to an external power source. The inverter can also supply 120 VAC electrical power.

To connect the Tiffin Open Trail to an external source of 120 VAC electrical power, it is first recommended that main 30-amp circuit breaker is in the “off” position. This is done to prevent any power surge upon connecting the unit to the external power source. The standard, flexible, power cord supplied with the Tiffin Open Trail is designed to handle 30 amperes. Make sure that the pins in the male end of the plug are oriented correctly so they match the power cable, and they are in good condition (i.e., aren’t bent or damaged).



## CAUTION

**Failure to turn off the 120 VAC appliances when starting or stopping the generator may damage the transfer switch and/or electrical appliances.**

**Note:** Do not attempt to use any electrical adapters to convert the provided 30amp power cord, as this will damage electrical components inside the Van.

If there is a circuit breaker switch at the “plug” end of the power cord, that breaker should be turned “off” before making the connection. Insert the plug into the mating outlet and then turn the circuit breaker “on.” Close and lock the electrical compartment door to protect the contents and to keep them clean and dry. Close the cover on the power box, if so equipped, to avoid an unintentional disconnection and to keep the contents clean and dry. Then switch the main breaker to the “on” position.

## Power Source Transition Procedure:

To ensure safe and optimal operation of the air conditioning system, owners must follow the procedures below when connecting to or disconnecting from shore power, generator power, or the 51V inverter system.

### Shore Power Connection

- Before connecting or disconnecting from shore power, ensure the air conditioner is turned off at the thermostat.
- When connecting to shore power, wait at least 3 minutes after the connection is established before turning the air conditioner back on.

## Generator Power Transition

- Prior to disconnecting from shore power and switching to generator power, turn the air conditioner off at the thermostat.
- After the generator has started and power is confirmed, wait 3 to 5 minutes before turning the air conditioner on.

## 51V Inverter System

- Before transitioning from shore power to the 51V inverter system, ensure the air conditioner is off at the thermostat.
- Once the inverter system is active and power is established, wait 3 to 5 minutes before powering on the air conditioner.

## Shore Power:

The Tiffin Open Trail utilizes the SmartPlug (Figure 6-1) for shore power located at the rear of the unit on the driver's side. The 30-amp shore power cord (Figure 6-2) can be used to charge the house battery or power the Open Trail directly

Note: Do not attempt to use any electrical adapters to convert the provided 30amp power cord, as this will damage electrical components inside the Van.

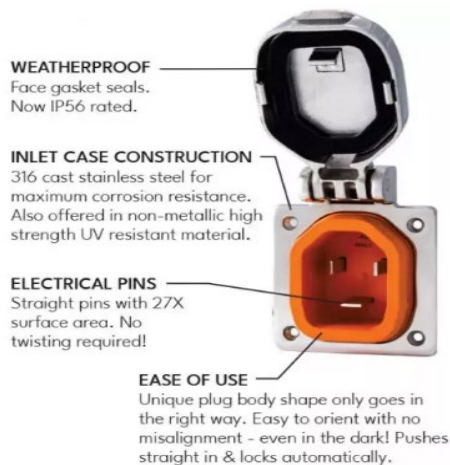

Figure 6-1: SmartPlug



Figure 6-2: 30-amp Shore Power Cord

## Batteries:

The Tiffin Open Trail comes equipped with a 3.2-kilowatt RVMP diesel generator, designed to provide consistent power for onboard systems, ensuring reliability when shore power isn't available. The standard power configuration includes a 270 amp-hour (3,456 watt-hour) Battleborn lithium battery pack, which offers deep-cycle energy storage with high efficiency and long-lasting performance. This lithium battery system supports a steady power supply for appliances, electronics, and vehicle functions while reducing generator runtime, making it an ideal setup for extended off-grid use.

For those seeking an upgraded energy solution, the Open Trail also offers an optional 51V 165AH (8,448 WH) Lithionics Battery System. This high-capacity lithium power option provides nearly double the energy storage compared to the standard Battleborn pack, enabling longer durations

between charges and increased power output for demanding applications. With advanced iONbus technology, the Lithionics system enhances battery monitoring and management, optimizing efficiency for users who require superior performance during travel or remote stays. This upgrade ensures a more powerful and resilient energy foundation for RV enthusiasts who prioritize extended off-grid capabilities.

1. **Regular Charging** – Keep the batteries charged within their recommended range. Avoid letting them fully discharge for extended periods, as this can affect performance.
2. **Temperature Management** – Lithium-ion batteries perform best in moderate temperatures. Protect them from extreme heat or cold, as excessive temperatures can degrade battery life.
3. **Proper Storage** – If storing for an extended period, ensure batteries are charged to around 50% and kept in a cool, dry place. Disconnect any unnecessary loads to prevent gradual drain.
4. **Avoid Overloading** – Do not exceed the power capacity of your battery system. Check that all connected devices operate within the battery's specifications.
5. **Routine Inspections** – Periodically check cables, connections, and terminals for signs of corrosion, loose connections, or damage. Address any issues promptly to prevent performance loss.

By following these steps, you'll ensure that your battery system remains reliable and efficient for your travels.

## Inverter:

The Tiffin Open Trail is equipped with a 3000-watt Xantrex inverter, providing seamless power conversion for onboard electrical systems. This high-capacity inverter efficiently transforms DC battery power into AC electricity, enabling the use of household appliances, entertainment devices, and essential RV functions without reliance on shore power or generator usage. Designed for reliability and energy efficiency, the Xantrex inverter supports a smooth transition between power sources, ensuring optimal performance for travelers who require uninterrupted energy access while on the road. Its advanced features help maximize battery life while delivering consistent, clean power to the Open Trail's electrical setup.

Maintaining your 3,000-Watt Xantrex inverter ensures optimal performance and longevity. Here are some key maintenance steps:

1. **Regular Inspection** – Periodically check for dust buildup, loose connections, and signs of wear on cables and terminals.
2. **Cooling System Care** – Ensure the inverter's ventilation is unobstructed and clean the cooling fans to prevent overheating.
3. **Battery Maintenance** – If connected to a battery bank, monitor battery health, voltage levels, and ensure proper charging cycles.
4. **Load Management** – Avoid overloading the inverter beyond its rated capacity to prevent strain on internal components.
5. **Environmental Protection** – Install the inverter in a dry, well-ventilated area to prevent moisture damage.

6. **Periodic Testing** – Run occasional tests to verify proper operation and troubleshoot any irregularities.

## Battery Disconnect Switch:

The master battery disconnect switch (Figure 6-3) on the Tiffin Open Trail is strategically placed to provide easy access and efficient control over the vehicle's electrical power. This essential component allows users to quickly disconnect the battery when necessary, improving safety and preventing unnecessary power drainage. When set to the "OFF" position, this switch prevents the batteries from receiving any charge from the 30A shore power connection. This isolation ensures that onboard electrical components do not inadvertently drain the battery when external power is unavailable. However, an exception to this disconnection is the auxiliary alternator charge, which remains active while the vehicle is running. This design helps maintain battery charge without interruption during transit, providing reliability and efficiency for continuous power needs.



Figure 6-3: Battery Disconnect Switch

## 120 – VOLT AC (VAC) Receptacles:

Your Tiffin Open Trail is equipped with several 120 VAC receptacles (Figure 6-4) located throughout the interior of the motorhome.

These 120 VAC receptacles are of the “three-prong” variety; the third prong being a grounding pin which provides adequate grounding to protect one from any electrical shock.

For these receptacles to work properly, do not use an adapter, cheater, or extension cord which defeats the function of the grounding pin. For the same reason, never remove or bend away the ground prong or pin from any three-prong AC plug so that it would fit a two-prong AC receptacle (i.e., an ungrounded AC receptacle).

Never operate the Tiffin Open Trail if there is an electrical short present, as an electrical short may deliver an electrical shock to anyone coming in contact with the exterior of the unit.

If you should feel even the slightest of electrical shock, immediately disconnect the unit from the 120 VAC power source and contact a technician for assistance.

Do not reconnect the 120 VAC power until after that electrical fault is fixed— the grounding circuit must be continuous from the frame to the distribution panel, to the power cord, and to the earth ground so that electrical-shock protection is realized.



Figure 6-4: 120 VAC Receptacle

## Ground Fault Circuit Interrupt (GFCI) Receptacles:

The Tiffin Open Trail is equipped with 120 VAC GFCI receptacles (Figure 6-5), which provide greater protection against inadvertent electrical shocks.

These specialized GFCI receptacles provide both overload and short-circuit protection for the user.

All GFCI-protected receptacles are marked as such, but only one of them may have two pushbuttons on the receptacle (as shown in the picture). The upper pushbutton is a “test” button which can be used to assure that the GFCI function is working—to test this function push that upper button: There will be a momentary “click” and the circuit will be disconnected (i.e., no power is available at the GFCI-protected receptacles). To reset this GFCI breaker, push the lower button (the “reset”)

These receptacles protect the user from ground faults between an electrically “hot” wire and ground. The GFCI will not reduce the shock hazard if the short is between a neutral and “hot” wire, or two “hot load” wires. The GFCI should be tested at least once a month. The 120 VAC electrical system must be “on” for the GFCI to be tested. To test the GFCI the reset button needs to be pushed in fully before starting the test. Push the test button; this will cause the reset button to pop out which means that the protected circuits have been disconnected. Push the reset button back in until a “click” is heard—this will re-activate the protected circuit. If the GFCI is working properly, the reset button will remain in the “in” position.

## Circuit Breakers:

The circuit breakers and fuses are installed to protect the electrical system of the Tiffin Open Trail from any overloads. Do not attempt to change the electrical circuitry or to add appliances yourself.

Please consult an authorized Tiffin Open Trail dealership to determine whether any changes you desire are appropriate and acceptable. Tiffin qualified staff of electricians can readily determine whether any changes sought (e.g. solar, radio, amateur radio, satellite television receiver, personal computer system, and the like) are possible or not and can advise you on how best to realize these enhancements.

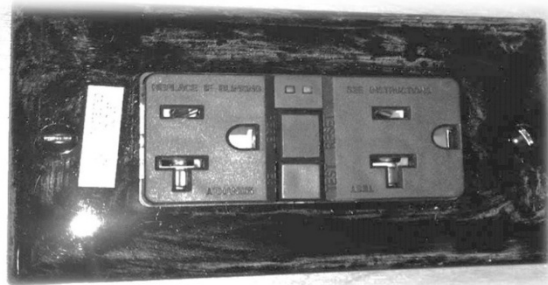

Figure 6-5: 120 VAC GFCI Receptacle



Figure 6-6: 120 VAC Distribution Load Center

The circuit breakers are housed within the primary 120 VAC distribution load center (Figure 6-6), located at the bottom of the galley base cabinet (Figure 6-7).

The panel has a main 30amp breaker which turns off all incoming power to the panel's branch breakers. All branch breakers are labeled as to their function.

## Firefly Integrations Mira Module:

The Tiffin Open Trail is equipped with the Firefly Integrations Mira Module, a smart control system that allows users to manage various coach functions through the VegaTouch app. This module provides seamless integration with lighting, HVAC, and power monitoring, offering a centralized and intuitive interface for controlling your RV.

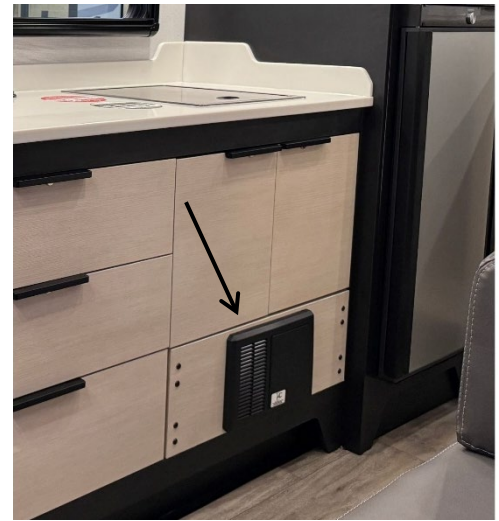

Figure 6-7: Load Center Location

### Setting Up the VegaTouch App for Local Bluetooth Control:

#### Step 1: Download the App

- Open the App Store (iOS) or Google Play Store (Android).
- Search for VegaTouch Mira and install the latest version.

#### Step 2: Enable Bluetooth & Location Services

- Go to your phone's Settings.
- Turn Bluetooth On.
- Enable Location Services (required for app connectivity).

#### Step 3: Connect to Your Coach

- Open the VegaTouch Mira app.
- Select "Connect to Coach".
- Enter your user-specific PIN (provided in your Owner's Information Package)
- Wait for the app to authenticate and establish a Bluetooth connection.

#### Step 4: Verify Connection

- Ensure the NET LED on the Mira module is solid green, indicating proper operation.
- If the LED is flashing or red, troubleshoot by checking the RV-C cable connection and restarting the module.

#### Step 5: Control Your Coach

Once connected, you can:

- Adjust lighting and HVAC settings.
- Monitor power usage.
- View system diagnostics.

## Solar Controller:

The Tiffin Open Trail is designed with solar readiness in mind. It comes standard with prep for two solar panels, meaning the necessary wiring and connections are already in place for easy installation. Additionally, it includes a 30-amp solar controller, which helps regulate the power from the solar panels to prevent overcharging and ensure efficient energy use.

For those looking to enhance their solar capabilities, there is an optional upgrade available. This upgrade allows for the installation of two 200-watt solar panels, providing increased power generation for off-grid adventures.

## Starlink Mini:

The Tiffin Open Trail is designed to keep you connected wherever your travels take you, coming standard with Starlink prep for seamless satellite internet integration. This means the vehicle is prewired and ready to support Starlink, ensuring a hassle-free setup for high-speed connectivity on the road. For those who want instant access to satellite internet without additional installation steps, the Tiffin Open Trail also offers an optional Starlink Mini—a compact yet powerful system that delivers reliable internet service in remote locations. Whether you're working remotely, streaming entertainment, or staying in touch with loved ones, the Open Trail connectivity options make it easier than ever to enjoy modern conveniences while exploring the open road.

### **1. Download the Starlink App**

Download the Starlink App and scan the QR code to step through the install process.



## 2. Find A Clear View of Sky and Check for Obstructions

Your Starlink needs a clear view of the sky so it can stay connected with satellites as they move overhead. Objects that obstruct the connection between your Starlink and the satellite, such as a tree branch, pole, or roof, will cause service interruptions. Use the obstruction tool in the app to ensure you have selected a suitable mounting location.

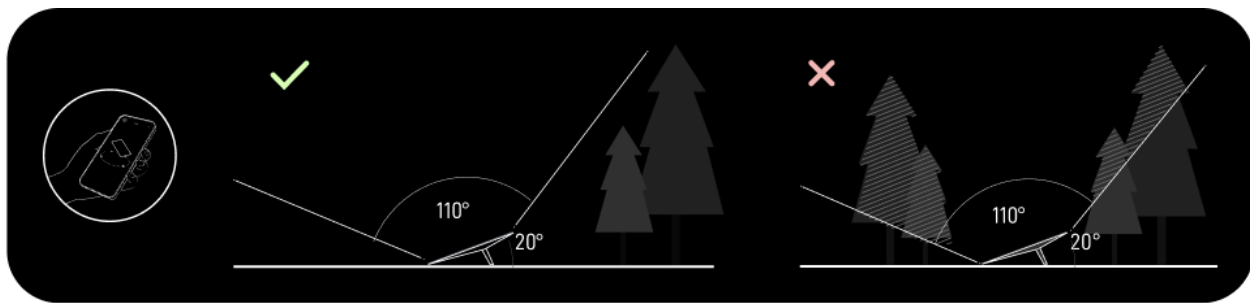

If you could not find a clear field of view from the ground level, consider installing in an elevated location, like a roof, pole, or wall.



## 3. Plug in Starlink

The Starlink Mini has an integrated Wi-Fi router, meaning a separate router is not required to get online. Lift the kickstand and plug one end of the provided cable into your Starlink. Ensure the plug is fully inserted such that the plug face is flush with the surface.

Route the other end of the power cable to your power supply and plug it into a power outlet.

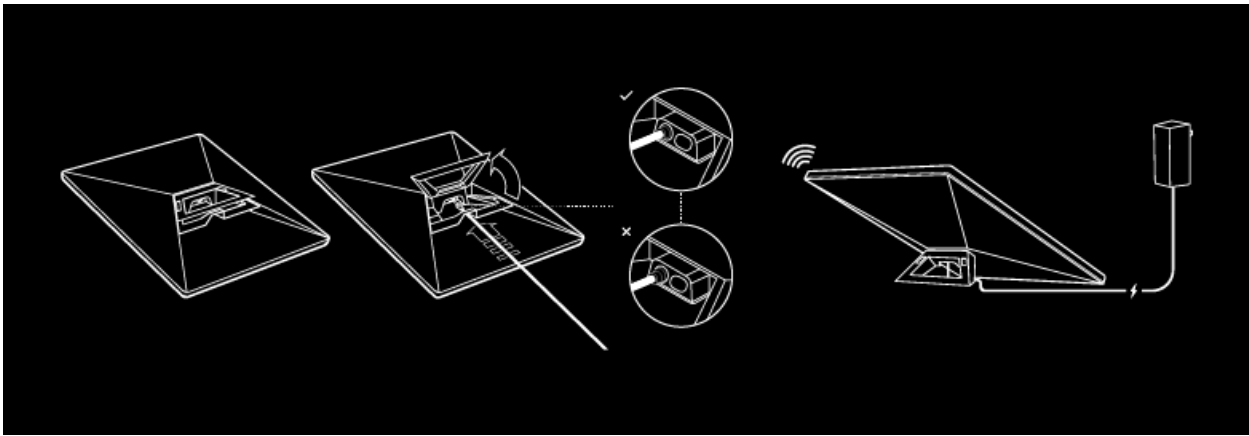

#### 4. Connect to Wi-Fi

- a. On your device, find and connect to the STARLINK network in your Wi-Fi settings
- b. To secure your Starlink Wi-Fi network, use the Starlink App to rename your Starlink Wi-Fi network and create a Wi-Fi password. Open the Starlink App > Settings > Router > enter the desired Wi-Fi network name and password > Save.
  - This step is optional, but we recommend securing your Wi-Fi network.

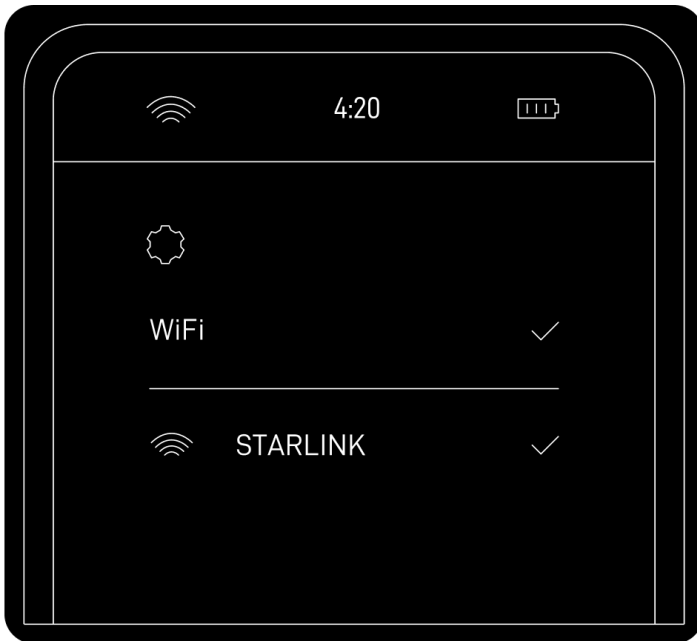

c. You are now connected! Open the Starlink App to customize additional settings, check your connection, and more.

**5. Align Starlink** Your Starlink Kit needs to face the right direction to connect to the maximum number of satellites for the strongest connection. Set up Starlink, ensuring the kit is tilted using the kickstand.

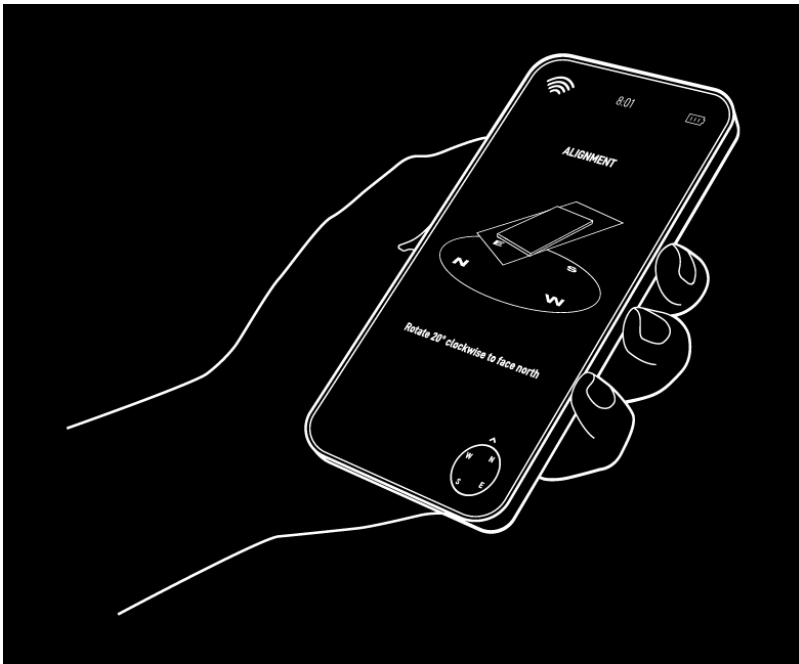

**Note:** If your Starlink is aligned within 5°, the app will not alert you, indicating your Starlink is properly aligned.

**Multiple Starlinks:** If installing multiple Starlinks in one location, the minimum separation distance from the mount center to mount center should be 3 meters. A third-party router can be used to connect the Starlinks together into one network and provide load balancing, traffic shaping, failover, and other advanced capabilities.

### Can't Get Online?

1. Open the Starlink App to check for any alerts, outages, or obstructions.
2. Check the status light on the back of your Starlink.
  - **Slow Blinking:** Powered on.
  - **No Light:** No power to Starlink.
  - **Fast Blinking:** LED will blink quickly for 3 seconds while holding down the reset button, then LED will turn off as your Starlink reboots.

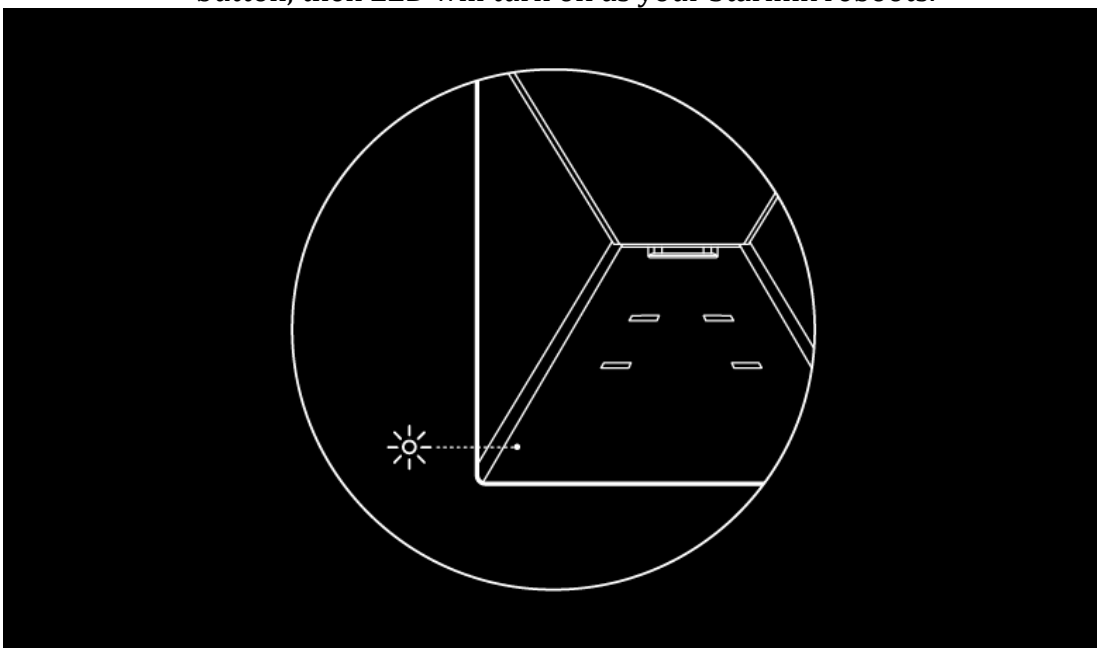

3. Make sure everything is securely and fully plugged in and there is no damage to hardware or cables.
4. Power cycle your Starlink by unplugging from power and then plugging back in.
5. Factory reset the Starlink by locating the reset icon on the back. Press down firmly until you hear or feel a click and hold for 3 seconds. The LED will blink quickly and shutoff when complete. Step through the install process to set up your Mini and get online.
6. Starlink Mini operates with an input voltage range of 12-48V. If you're experiencing issues while using a 12V power supply or battery, try reducing the cable length or using a thicker gauge cable. You can also improve performance by supplying power at a higher voltage if possible. An easy solution is to use the Starlink Mini USB-C cable with a 100W USB-C power supply or the Starlink Mini Car Adapter.

Note: Your network name and password will be reset after completing factory reset. Look for 'Starlink' network during setup and configure your network to your preferred network name and password.

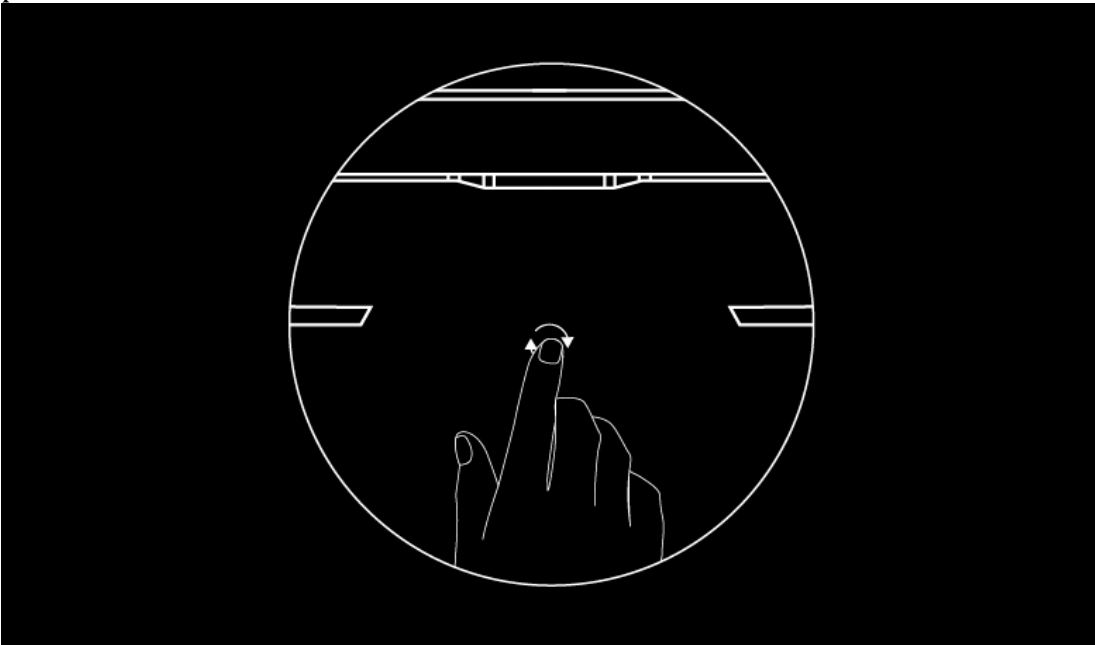

### **Using Mesh or Third-Party Router**

If you want to set up a mesh system with a Starlink router, you can hardwire a router via an ethernet cable into the RJ45 port or create a wireless mesh network. You can also use your own router via the RJ45 port in bypass mode.

To hardwire a router to your Mini:

1. Remove the Starlink Plug.

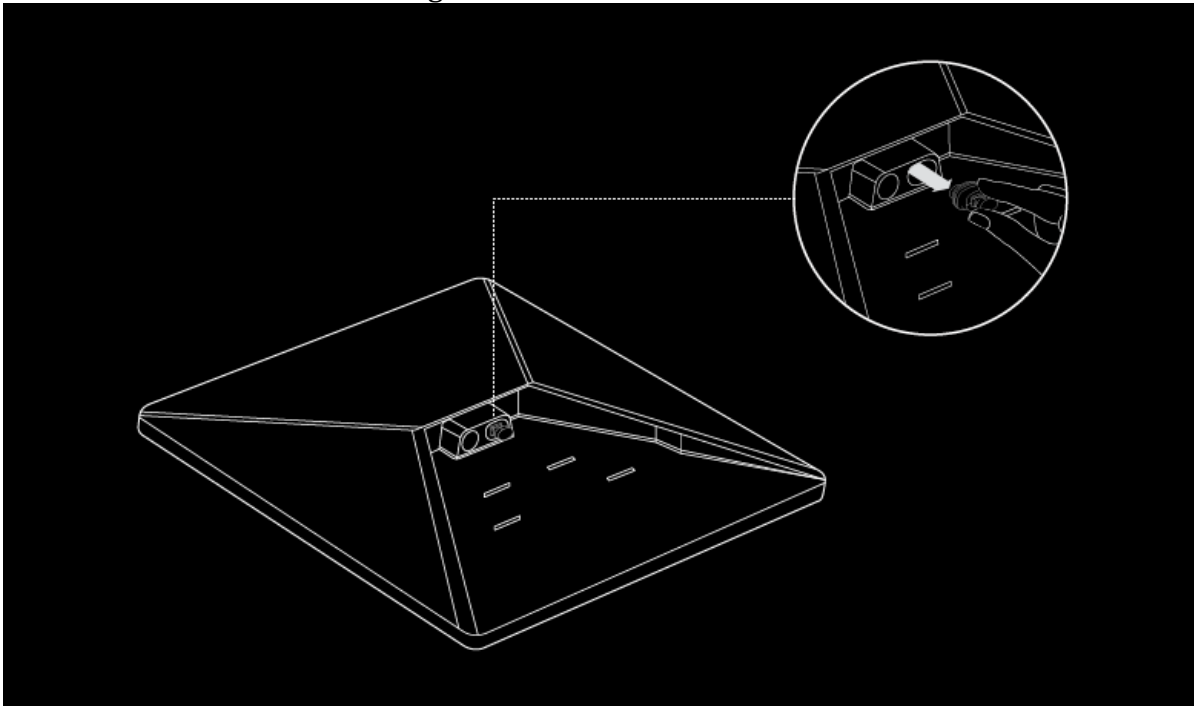

2. Plug the Mini Starlink Cable available on [starlink.com/shop](https://starlink.com/shop) or your own ethernet cable into the ethernet port. Connect the other end of your cable to a Starlink Gen 3 router or third-party hardware.

Note: Use the Mini Starlink Cable available on [starlink.com/shop](https://starlink.com/shop) to protect your dish against water ingress. The Mini is no longer IP67 rated waterproof with a third-party RJ45 cable.

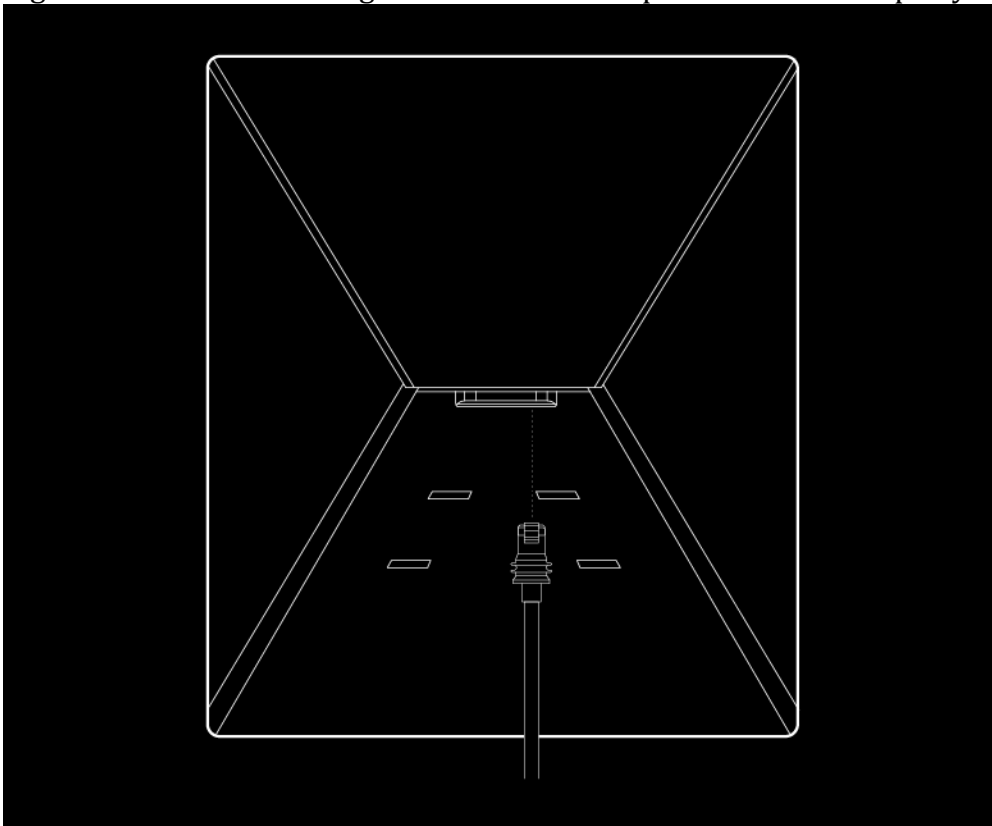

3. If you're using a third-party router, use the Starlink App to put the integrated Wi-Fi router into bypass mode. Manual factory reset is required to disable bypass mode.

# ***OPEN TRAIL***

## **EXTERIOR FEATURES**

---

**Chapter**

**7**

## Towing Hitch:

The Tiffin Open Trail is equipped with a sturdy towing hitch (Figure 7-1) located at the rear, designed to accommodate a maximum towing capacity of 5,000 pounds. This feature allows for effortless hauling of trailers, small vehicles, or additional gear, making it ideal for extended road trips or recreational adventures. Engineered for durability and reliability, the hitch is seamlessly integrated into the vehicle's frame, ensuring a secure and stable towing experience.



Figure 7-1: Towing Hitch

The towing hitch features a standard 7 pin wiring connector. If desired, a trailer brake actuator can be added.

The Open Trail is capable of towing light loads, and instructions are in the chassis manufacturer's literature in the Owner's Information Package provided with the Open Trail.

The total weight of the Open Trail and any vehicle towed by the Open Trail must not exceed the Gross Combined Weight Rating (GCWR).

**NOTICE. If drop hitch or receiver extension is added to coach, it reduces ton capacity by half.**

The tongue weight must not exceed 10 percent of the towing capacity. Information related to the Open Trail weight and GCWR can be found on a sticker inside the Open Trail . Any vehicles to be towed by the Open Trail must have adequate active braking.

**Tiffin Motorhomes does not recommend using any type of hydraulic towing lift that attaches to the rear of the Open Trail designed to carry motorcycles, scooters, golf carts, etc.**

## Loading and Towing Tips:

Enhance safety and performance while traveling with these essential loading and towing tips. Learn how weight distribution affects stability and understand towing dynamics for a smoother journey. Explore key strategies for optimal loading and towing practices.

### Weight Distribution:

- Distribute weight equally side-to-side and emphasize the front.
- Placing weight towards the front enhances hitch weight for a steadier tow.
- Watch for signs of less control or swaying, indicating potential weight imbalance.

### Travelling with Full Tanks:

- Full tank can lead to weight distribution issues.
- With each gallon of water weighing about 8 pounds, the total weight can increase rapidly when multiple tanks are filled.
- Consider the extra weight of full water tanks when traveling, as it can impact stability and fuel efficiency.

### Evaluating Vehicle Weight:

- Ensure the vehicle's weight is compatible with your tow vehicle.

- Excessive weight can lead to longer stopping distances and potential damage to both vehicles.

### **Vehicle Weight Standards and Certification:**

- Ensure the total weight of the Open Trail and any towed vehicle remains within specifications.
- The combined weight must not exceed the Gross Combined Weight Rating (GCWR).
- The vehicle and hitch weight must stay within the Gross Vehicle Weight Rating (GVWR) and Rear Gross Axle Weight Rating (GAWR), as specified on the Vehicle Certification Label.
- Always check GCWR, GVWR, and GAWR on the certification label to ensure compliance.

### **Maintaining Proper Weight Distribution:**

- Measure your loaded vehicle's weight at a weigh scale for precise weight distribution.
- Utilize the results to refine and enhance future loading strategies.

### **Adapting to Vehicle Handling While Towing**

- Recognize that vehicle handling changes when towing a trailer.
- Expect longer stopping distances; ensure the trailer's braking system is functional and properly connected.

## **Vehicle Loading & Weight Guidelines:**

This section offers key guidance on proper vehicle loading to ensure the loaded weight remains within designated limits, whether towing or not. Maintaining balanced loading enhances vehicle performance and prevents exceeding critical weight ratings.

### **Gross Vehicle Weight Rating (GVWR):**

- The maximum permissible weight of the fully loaded and travel-ready vehicle.

### **Gross Axle Weight Rating (GAWR):**

- The load carrying capacity of a single axle system (front or rear), as measured at the tire-ground interface. Indicated on the Safety Compliance Certification Label.

### **Occupant and Cargo Carrying Capacity (OCCC):**

- Is equal to the GVWR, minus UVW. In other words, OCCC is the amount of weight in occupants, cargo, water and trailer tongue weight that can be added to the vehicle, without exceeding the GVWR.

### **Unloaded Vehicle Weight Rating (UVW):**

- The weight of the vehicle as manufactured at the factory, including full fuel, engine oil, and coolants.

### **Base Curb Weight:**

- The weight of the vehicle, including a full tank of fuel and standard equipment, excluding passengers, cargo, or optional equipment.

## Vehicle Curb Weight:

- The weight of a new vehicle when acquired from the dealer, plus any added aftermarket equipment.

## Calculating Vehicle & Load Weights:

Follow these guidelines and use a weigh scale to accurately determine your vehicle's load:

### Gross Vehicle Weight (GVW):

- Place the entire vehicle (both axles) onto the scale.

### Front Gross Axle Weight:

- Drive the front wheels only onto the scale.

### Rear Gross Axle Weight:

- Drive the rear wheels only onto the scale.

### Comparison with GVWR:

- Compare the Gross Vehicle Weight (GVW) with the Gross Vehicle Weight Rating (GVWR) on the label.

### Standards:

- If the GVW exceeds GVWR, reduce the total vehicle load.
- If GVW is less than GVWR, check the Front and Rear Gross Axle Weights against the Front and Rear Gross Axle Weight Rating (GAWR) on the label.
- If either axle weight exceeds GAWR, redistribute the load to ensure both front and rear axles stay within required limits.

## Motion-Sensor Lights in Cargo Bay:

The Tiffin Open Trail is equipped with motion sensor lights in the cargo bay, providing enhanced visibility and convenience when accessing storage areas. These lights automatically activate when movement is detected, ensuring that users can easily locate and retrieve items without needing to manually switch on a light. Designed for efficiency, the motion sensors help conserve energy by turning off when no activity is detected. This feature is particularly useful in low-light conditions or when loading and unloading gear, making the cargo bay more accessible and user-friendly.

### Disabling Motion Sensor Mode

1. **Locate the Cargo Light Switch** – The switch is found on the light in the cargo bay.
2. **Identify the Three Switch Positions** – The switch has three modes:
  - **ON** – Lights remain on continuously.
  - **AUTO (Motion Sensor Mode)** – Lights activate when movement is detected.
  - **OFF** – Lights remain off regardless of motion.
3. **Set to OFF Mode** – Toggle the switch to the OFF position to disable the motion sensor feature.

## Running Boards:

The Tiffin Open Trail is designed with driver and passenger running boards (Figure 7-2), providing easy access into the cab area. These sturdy, well-integrated steps enhance convenience by offering a stable platform for entering and exiting the vehicle, especially in elevated or off-road conditions. Built for durability, the running boards ensure a secure foothold, making them ideal for travelers who frequently transition between the cab and the living space. Whether stepping in for a long drive or hopping out to explore, these running boards contribute to the Open Trail's user-friendly design and overall accessibility.

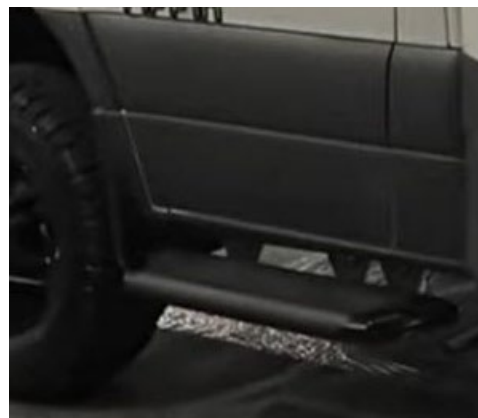

Figure 7-2: Running Board

# ***OPEN TRAIL***

## INTERIOR FEATURES

---

### Chapter

# 8

## Flooring:

The Tiffin Open Trail is designed with both durability and style in mind, featuring linoleum flooring throughout the interior. This flooring choice provides a sleek, easy-to-clean surface that is resistant to wear and tear, making it ideal for life on the road. Linoleum is known for its low-maintenance qualities, ensuring that spills and dirt can be quickly wiped away, keeping the motorhome looking fresh and inviting. Additionally, it offers a comfortable underfoot feel while complementing the overall aesthetic of the Open Road's interior design. Whether parked at a scenic campsite or cruising down the highway, the linoleum flooring enhances the practicality and elegance of this motorhome.

Cleaning linoleum flooring in your Tiffin Open Trail requires a gentle approach to maintain its durability and shine. Here's a simple method to keep it spotless:

### Step-by-Step Cleaning Guide

1. **Sweep or Vacuum** – Remove loose dirt and debris using a soft-bristle broom or a vacuum with a hard floor setting.
2. **Prepare a Cleaning Solution** – Mix warm water with a small amount of mild dish soap or white vinegar (avoid harsh chemicals).
3. **Mop the Floor** – Use a damp mop, not soaking wet, to clean the surface. Excess water can seep into seams and damage the flooring.
4. **Spot Clean Stains** – For stubborn dirt, apply rubbing alcohol or a baking soda paste (mix baking soda with water) and gently scrub with a soft cloth.
5. **Dry the Floor** – Use a dry microfiber cloth or allow the floor to air dry completely before walking on it.

### Additional Tips

- Avoid rubber-backed rugs, as they can cause discoloration.
- Never use ammonia-based cleaners, as they can damage the linoleum.

## Ceiling:

The ceiling of the Tiffin Open Trail is adorned with a padded vinyl headliner, combining both aesthetic appeal and functionality. This material is designed for durability and ease of maintenance, ensuring it remains in excellent condition with minimal effort.

1. **Prepare the Cleaning Solution:** Dampen a soft cloth with water and a mild detergent.
2. **Wipe the Surface Gently:** Use the cloth to remove dust, dirt, or stains, ensuring a smooth and even application.
3. **Avoid Abrasive Materials:** Do not use harsh brushes or scrubbing tools, as they may damage the vinyl's texture.
4. **Steer Clear of Harsh Chemicals:** Refrain from using strong cleaning agents, such as bleach or ammonia, to preserve the vinyl's appearance and integrity.

It is particularly important to pay close attention to cleaning around the vent areas. Vents can accumulate dirt, grease, or other debris over time, which may impact airflow and overall cleanliness. Regular cleaning in these areas will not only maintain the appearance of the ceiling but

also ensure optimal functioning of the ventilation system. Periodic upkeep of the headliner and vents will contribute to a more comfortable and hygienic environment within your vehicle.

## Window Treatments:

The TIFFIN Open Trail is outfitted with high-quality blackout window shades and a screen shade (Figure 8-2), offering a flexible and customizable window covering system. The blackout shade is designed to completely block out external light, providing optimal privacy and a darkened interior when needed. Meanwhile, the screen shade allows for airflow while preventing insects from entering, making it ideal for ventilation without compromising comfort.



Figure 8-2: Window Shades

Both shades are fully adjustable, allowing you to control how much of the window you wish to cover. By raising or lowering the shades, you can choose to fully block the window for complete privacy or selectively adjust them to cover only a portion, depending on your preference. This versatility ensures that you can create the perfect balance of light, airflow, and privacy to suit your needs, whether you're enjoying natural light during the day or seeking a restful environment at night.

The design and operation of these shades are user-friendly, allowing occupants to easily adjust or deploy them as needed. Regular maintenance and cleaning are recommended to ensure their longevity and continued performance.

### Operating the Shade:

1. **Opening the Shade** – Gently raise or lower the shade to expose the screen. This allows fresh air to circulate while keeping insects out.
2. **Adjusting Airflow** – The pleated design enables partial opening, so you can control ventilation while maintaining bug protection.
3. **Blackout Mode** – When full shade is needed, lower the blackout fabric completely to block sunlight and create a cool, dark interior.
4. **Closing the Shade** – Simply raise or lower the shade back into its housing when not in use.

### Cleaning the Shade:

1. **Dust Regularly** – Use a soft brush or a vacuum with a brush attachment to remove dust and debris from the shade. This prevents buildup and keeps the fabric looking fresh.
2. **Spot Cleaning** – If there are stains, gently blot the affected area with a damp cloth and mild soap. Avoid scrubbing, as it may damage the fabric.
3. **Avoid Harsh Chemicals** – Stick to mild detergents and avoid strong cleaners that could degrade the material.
4. **Dry Properly** – Allow the shade to air dry completely before retracting it to prevent moisture buildup and mold growth.

# ***OPEN TRAIL***

## **PLUMBING & BATH FEATURES**

---

### **Chapter**

# **9**

## Shower:

The Tiffin Open Trail features a 48x32 full residential-style wet bath (Figure 9-1), designed for both comfort and functionality. It includes a large shower skylight, allowing for natural light and an open feel, while the roof vent fan ensures proper ventilation. Practical additions like towel and toilet paper holders keep essentials within reach, and an oversized mirror with a hidden medicine cabinet (Figure 9-2) provides convenient storage for toiletries. Completing the space is a large black aluminum under-sink cabinet, offering extra room to keep personal items organized. This setup brings home-style convenience to your adventures!



Figure 9-1: Shower



Figure 9-2: Mirror with Medicine Cabinet

## Shower Exhaust Fan:

The Tiffin Open Trail is equipped with a MAXXFAN Dome shower fan exhaust (Figure 9-3) located in the wet bath, providing efficient ventilation to remove moisture and odors. This powerful fan helps maintain a fresh and comfortable environment by circulating air and preventing excess humidity buildup. Designed for reliability, the MAXXFAN Dome enhances the overall functionality of the wet bath, ensuring a more enjoyable experience for travelers on the road.

### Opening and Closing the Lid

- To open the MAXXFAN Dome lid, press the button on the handle to disengage the clip, then slide the handle away from you until the clip securely engages in the upper opening.
- To close the lid, press the button on the handle to disengage the clip, then pull the handle toward you until the clip securely engages in the lower opening.

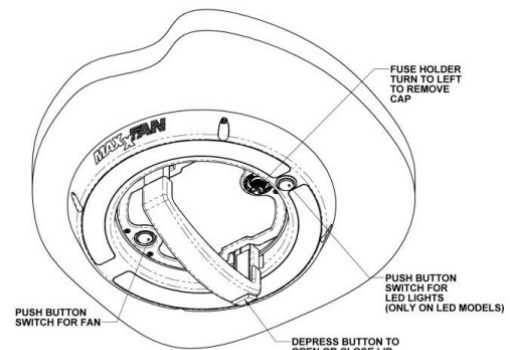

Figure 9-3: Maxxfan Exhaust

## Fan Operation

- To operate the MAXXFAN Dome fan, simply press the ON/OFF button located on the fan unit to activate the exhaust fan.
- Important: The fan should not be operated with the lid closed, as this may impede airflow and affect performance.

## LED Lighting Operation

- The optional LED lighting (Figure 9-4) located on the garnish ring is controlled by the push-button on the garnish ring.
- The LED lighting and fan operate independently, allowing users to control each feature separately.



Figure 9-4: Maxxfan LED Lighting

## Airflow Control

- Close the lid to minimize air infiltration when the exhaust fan is not in use.

## Shower Operation:

Tiffin Open Trail features a ShowerMiser (Figure 9-5), an innovative and highly efficient system engineered to enhance water conservation. Its main purpose is to conserve water by redirecting cold water that would typically go down the drain while you're waiting for the hot water to arrive. Here's how it works:

1. **Recirculating Cold Water:** When you turn on the shower, the cold water is rerouted back into the freshwater tank instead of being wasted in the gray water tank.
2. **Indicator System:** The ShowerMiser has a color-changing indicator (Figure 9-6) that lets you know when the water is hot and ready for use.
3. **Simple Operation:** To operate the system, simply adjust the lever (Figure 9-7) ensuring a seamless and user-friendly experience.

This system is especially useful for dry camping, as it helps extend the capacity of both your fresh and gray water tanks.

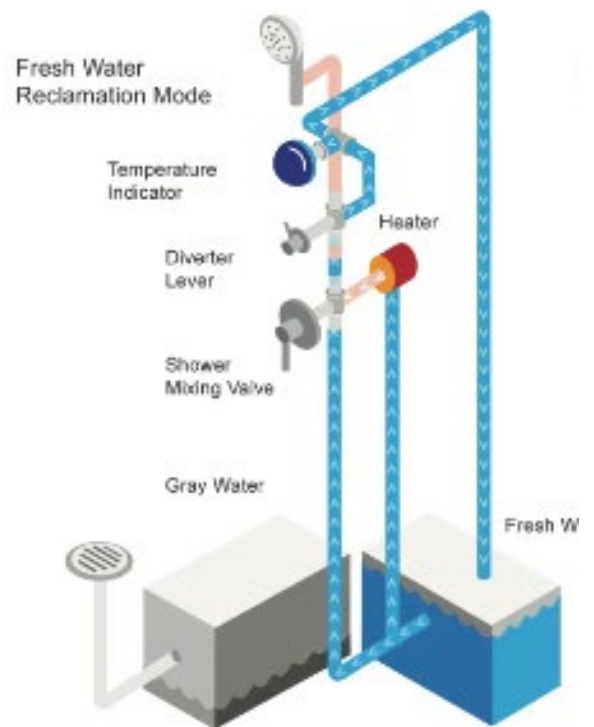

Figure 9-5: ShowerMiser

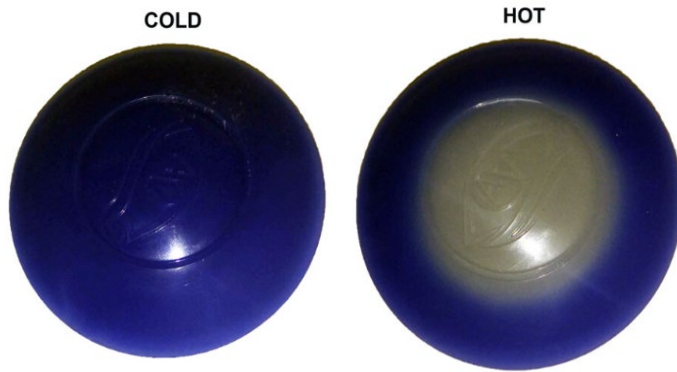

Figure 9-6: ShowerMiser Indicator



Figure 9-7: ShowerMiser Lever

## Water Pump:

The water pump is used to pressurize the freshwater system when the unit is not connected to city water.

### How to Start the Water Pump

#### 1. Fill the Freshwater Tank

- Completely or partially fill the freshwater tank to ensure an adequate supply.

#### 2. Open Faucets

- Turn on both the kitchen and bathroom faucets to allow air to escape from the system.

#### 3. Power On the Water Pump

- Switch the water pump to the “ON” position and let it run until the water fills the lines.

#### 4. Close Faucets Gradually

- Once a steady stream of water flows, close each faucet, starting with the cold-water faucet first.
- Leave the hot water faucets open until they also deliver a steady stream, then close them.

#### 5. Pump Operation Check

- The pump should automatically shut off when all faucets are closed.
- It will run when a faucet is opened and stop when the faucet is closed.

### Important Maintenance Notes

- **Avoid Dry Running:** Never let the pump operate for extended periods without water in the supply tank, as this can cause damage to components or blown fuses.
- **Drain System When Not in Use:** If the Open Trail will be unused for an extended time, drain the entire freshwater system to prevent buildup or damage.

Here are some troubleshooting tips for water pump on the Tiffin Open Trail:

### Common Issues & Fixes

#### 1. **Pump Won't Start**

- Check if the pump is receiving 12V power.
- Inspect loose wires or a blown fuse.
- Ensure the switch is turned on.

#### 2. **Pump Runs But No Water Flow**

- Verify that the freshwater tank is full.
- Check for clogged filters or blocked hoses.
- Inspect for air leaks in the system.

#### 3. **Pump Won't Shut Off**

- Look for leaks in the plumbing system.
- Ensure the pressure switch is functioning properly.
- Check for air trapped in the lines.

#### 4. **Low Water Pressure**

- Clean or replace clogged faucet aerators.
- Inspect for kinked hoses or blockages.
- Check if the pump diaphragm is worn out.

#### 5. **Pump Cycles On & Off Frequently**

- Look for small leaks in the system.
- Ensure the pressure tank is working correctly.
- Check for faulty check valves.

### Sewer Bay:

The Tiffin Open Trail is equipped with the state-of-the-art Nautilus P3 Sewer Board (Figure 9-8); designed to simplify water management with efficiency and reliability. This innovative system allows seamless control over freshwater tank filling, city water connection, sanitation, and winterization, ensuring a hassle-free experience for motorhome owners. Its intuitive interface clearly marked handles, and user-friendly operation make adjusting water flow effortless. Additionally, the Nautilus P3 is engineered for easy maintenance, featuring smooth surfaces and accessible components that facilitate quick cleaning. Whether preparing for travel or winterizing the system, the Tiffin Open Trail integration of the Nautilus P3 Sewer Board enhances convenience and reliability on the road.



Figure 9-8: Nautilus Sewer Board

## Sewer Bay System Overview:

The operational guidelines for the Nautilus P3 valve system are as follows:

### 1. White Handle:

- Function: Receives water from the inlet located on the front panel.
- Sideways Position: Directs water to the pump inlet.
- Downward Position: Channels water into the blue-handled diverter.

### 2. Blue Handle:

- Function: Receives water from the white-handled valve, connected to the inlet on the front panel.
- Sideways Position: Facilitates water flow to the cold-water fixtures.
- Downward Position: Allows water to flow to or from the freshwater tank.

### 3. Green Handle:

- Function: Serves as an on/off valve controlling water flow from the freshwater tank to the pump.
- Sideways Position: Water will not flow through the valve
- Up Position: Water will go to or come from freshwater tank.

### 4. Red Handle:

- Function: Receives water from the cold-water supply line.
- Sideways Position: Routes water directly to the hot-water fixtures, bypassing the hot water heater.

### 5. Red Handle:

- Function: Receives water from the cold-water supply line.
- Sideways Position: Routes water directly to the hot-water fixtures, bypassing the hot water heater.

## City Water Connections:

To establish a reliable connection to the city water supply, begin by attaching one end of the hose to the designated city water inlet (Figure 9-9), located on the sewer board. This standard connection ensures a direct and consistent supply of water to your unit. Always ensure that the hose used is specifically manufactured and labeled for potable water service to maintain optimal water quality and prevent any alteration to the taste of the water. Proper connection and routine inspection of the fittings and hoses will help sustain an uninterrupted and dependable flow of water for extended use.

Turn the city water supply “on” for a few seconds to clear the line. Once the hose has been flushed, turn the supply “off.” Connect the other end of the hose to the inlet valve on the sewer board or outside inlet; turn the blue handle valve on the sewer board to the city water fixtures turn the red handle valve on the sewer board to normal. (Note: As the water goes through the inlet and then passes through the filter ensuring that all water exiting the faucets and showers have been filtered). Once the city water fill valve is opened, water is supplied to the freshwater system including the water heater, faucets, and toilet. Turn “on” the water supply and open all the faucets to clear any trapped air within the plumbing lines within the motor home.



Figure 9-9: Nautilus City Water Inlet

Once any air pockets have purged from the water lines and water flows freely, close all the faucets. The city water supply is pressurized; therefore, the water pump is not needed when the water system of the vehicle is connected to the city water system.

**The valves should never be turned while there is pressure on the lines.**

The freshwater tank is normally filled from the city water inlet on the sewer board. The red and blue handle valves located on the sewer board determine whether the city water is going through the water system or into the freshwater tank. To fill the freshwater tank, turn the blue handle valve to city fill tank, turn the red handle valve to normal. Since there is no automatic shut-off when filling the freshwater tank, check the level from the monitor panel while filling the freshwater tank on the motorhome. (NOTE: As your freshwater tank fills the water passes through the filter ensuring that the water in the freshwater tank has been filtered before use).

## Run Hot and Cold Fixtures from Fresh Water Tank:

After filling the freshwater, you are ready to run the water system from the freshwater tank supply.

1. **Turn “on” water pump.**
2. **On the sewer board turn the blue handle valve to the normal position and turn the red handle valve to the normal position.**

## Sanitizing Hot and Cold Fixtures and Freshwater Tank:

To assure complete disinfecting of the freshwater system, it is recommended that the following procedures be performed on a new system, on one that has not been used for a length of time, or one that may have become contaminated. This procedure is also recommended before long periods of storage, such as during the winter months:

1. **Drain the freshwater tank by opening the drain valve. All the faucets should be in the closed or “off” position.**
2. **Prepare a chlorine solution using one gallon of water and one-half cup of chlorine bleach (5% sodium-hypochlorite solution). Prepare enough of the chlorine solution to administer one gallon of solution for every 15 gallons of tank capacity. Concentrations greater than 50 ppm may damage the water lines and/or the tank.**
3. **Once the freshwater tank is empty, close the drain valves in the water tank.**
4. **Pour the solution into the gravity fill which is located on the rear of this coach.**
5. **Turn “on” the water pump. On the sewer board turn the blue handle valve to “normal” position and turn the red handle valve to “normal” position.**
6. **Open each faucet, in turning “on” both the hot and cold faucets and flushing the toilet until all the air has been purged from the pipes and the water runs freely. The entire system will then be filled with the sanitizing solution.**
7. **Allow the 50-ppm disinfecting solution to stand in the system at least four hours.**
8. **Drain the system and flush it with freshwater. The water system needs to be flushed with water repeatedly, if necessary, until there is no chlorine taste or smell left in the system. To remove any excessive chlorine taste or odor that might remain, prepare a solution of one quart of vinegar to five gallons of water. “Rock” the tank containing the solution; by moving the vehicle forward and backward several times to clean the tank; then drain that tank and refill with clean water.**

## Sanitizing Hot and Cold Fixtures Only (Not Freshwater Tank):

1. **All faucets should be in the closed or “off” position.**
2. **Prepare a chlorine solution using one gallon of water and one-half cup of chlorine bleach (5% sodium-hypochlorite solution). Concentrations greater than 50 ppm may damage the water lines.**
3. **Connect one end of the vinyl hose to the inlet valve on the sewer board; place the other end of the hose into the solution that has been prepared.**
4. **Turn “on” the water pump. On the sewer board turn the blue handle valve sanitize/winterize and turn the red handle valve to bypass.**
5. **Open each faucet, in turning “on” both the hot and cold faucets and flushing the toilet until all the air has been purged from the pipes and the water runs freely. The entire water lines will then be filled with the sanitizing solution.**
6. **When the sanitizing process is completed, turn the water pump “off”.**
7. **Allow the 50-ppm disinfecting solution to stand in the system at least four hours.**
8. **Drain the system and flush it with freshwater. The water lines will need to be flushed with water repeatedly, if necessary, until there is no chlorine taste or smell left in the system. To remove any excessive chlorine taste or odor that might remain, prepare a solution of one quart of vinegar to five gallons of water. Repeat steps four, five and six to run the solution through the water lines. Drain the system and flush with freshwater.**

## Toilet:

The toilet in your Tiffin Open Trail is designed for ease of use, efficient waste management, and long-term reliability. Proper operation and regular maintenance ensure maximum sanitation, functionality, and longevity.

To adjust the orientation of the toilet bowl, begin by closing the cover to prevent accidental movement of internal components. Using both hands, firmly grip the toilet bowl and rotate it to the desired position, keeping in mind that it has a maximum rotation of 90 degrees clockwise (Figure 9-10). This adjustability allows users to optimize the positioning of the toilet within the available space for enhanced comfort and convenience.

To ensure an efficient flush, always verify that the blade (Figure 9-11) is fully open before proceeding. Press and hold the flush button (Figure 9-12) for several seconds to initiate the flushing process. If needed, pulsating the flush by pressing the button multiple times in quick succession can enhance the effectiveness of the flush and promote thorough waste removal.

Your toilet is equipped with a level indication system for the waste-holding tank. When the slide transitions from green to red, it signals that the waste-holding tank is full and requires emptying to maintain optimal performance and hygiene. Regularly monitoring this indicator will help prevent overfilling and ensure smooth operation.



Figure 9-10: Toilet Bowl Rotation

This toilet system is highly versatile, operating effectively with water from either the freshwater tank (with the water pump turned “on”) or directly from the city water supply when connected. This dual-source functionality ensures continuous availability of flushing water in different scenarios, providing flexibility for various conditions and user preferences.

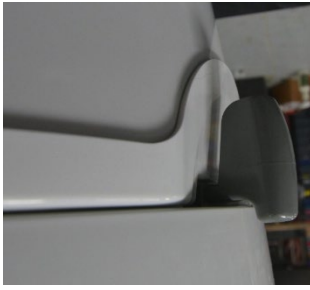

Figure 9-11: Blade Lever



Figure 9-12: Toilet Button

Before each use, it is essential to add water to the bottom of the toilet bowl to ensure efficient waste movement and flushing. Proper pre-use preparation prevents waste from sticking to the bowl surface and improves overall sanitation.

The toilet flushes waste directly into the black water holding tank, which serves as a containment system for wastewater until it is properly emptied at an appropriate disposal station. Regular monitoring of the black-water tank levels is advised to prevent overfilling, which may lead to system inefficiencies or unpleasant odors.

To maintain the highest standards of hygiene and operational efficiency, the toilet should be cleaned regularly. Routine cleaning helps prevent buildup of waste residue, bacteria, and odors, ensuring a fresh and sanitary environment. It is recommended to use a mild bathroom cleaner specifically formulated for toilet surfaces to avoid damage to the materials. Avoid harsh chemicals or abrasive scrubbing tools, as they may degrade the finish or weaken components over time.

By following these operational and maintenance guidelines, users can maximize the performance, hygiene, and lifespan of the toilet system, ensuring a comfortable and sanitary experience. Regular inspections and proper use will contribute to long-term reliability and convenience.

Never add toilet additives directly via the valve blade or via the toilet bowl as this could damage the lip seal of the waste-holding tank. Only fill the waste-holding tank via the pour out spout.

Never use force if you cannot get the waste-holding tank back into place easily. If blockage occurs, always check if the blade handle is in the closed position.

## Waste Water Disposal:

Your toilet is equipped with a streamlined waste-holding tank level indicator (Figure 9-13), designed for efficient monitoring—when the slide transitions from green to red, it signals that the tank is full and requires emptying. To ensure proper maintenance, begin by removing the waste-holding tank from the outside toilet tank door (Figure 9-14) and fully extend the pull handle before transporting it to an authorized waste disposal facility. Once positioned, place the tank upright, rotate the pour-out spout upward, and remove the cap. While keeping the pour-out spout angled downward, press and hold the vent button to facilitate a controlled and thorough emptying process. After disposal, introduce approximately five liters of water into the tank, securely replace the cap, and gently shake the unit to ensure internal cleanliness before emptying it again. Additionally, detach the float by rotating it clockwise and rinse it thoroughly with tap water to maintain optimal function. Conclude the process by retracting the pull handle until it locks securely, reinserting the waste-holding tank into the toilet, and closing the service door. If further use of the toilet is required, properly prepare the waste-holding tank for continued operation.



Figure 9-13: Level Indicator

## Sewer Connection and Camping:

The Tiffin Open Trail is designed with convenience and sanitation in mind. The gate valve and grey water dump connection (Figure 9-15) are strategically placed on the driver's side, just in front of the rear tire, making it easy to access and manage waste disposal.



Figure 9-14: Waste-Holding Tank

While using the Open Trail, it is crucial to always maintain the greywater holding-tank gate valve is in the closed position, except when actively dumping the contents. This practice helps ensure that enough liquid remains inside the tank, which plays a vital role in facilitating an effective and efficient draining process. Keeping the valve closed allows waste liquids to accumulate, preventing premature leakage and ensuring that the waste materials have ample fluid to mix with.



Figure 9-15: Grey Water Gate Valve

When the time comes to empty the holding tank, having a generous amount of liquid within it promotes a smoother outflow through both the gate and drain valves. The presence of an adequate liquid volume encourages a swirling motion inside the tank, which is beneficial for loosening and carrying away accumulated solid waste. This swirling action helps break down waste deposits that might otherwise stick to the interior surfaces of the tank, minimizing the chances of blockages and making the overall dumping process more thorough and effective.

Additionally, maintaining a closed valve when not dumping reduces the risk of unwanted odors escaping from the tank and helps prevent clogs by allowing solid waste to mix with the liquid over

time. It also extends the longevity of the system by ensuring proper waste disposal and minimizing residue buildup inside the tank. By following this method consistently, van users can maintain a more sanitary and hassle-free waste management system, avoiding common issues associated with improper dumping practices.

Using the gate valve and grey water dump on the Tiffin Open Trail is a straightforward process, but it's important to follow the correct steps to maintain sanitation and efficiency. Here's how to do it:

1. **Prepare the Dumping Area** – Park your motorhome at an approved dump station or designated wastewater disposal area. Make sure you have proper drainage access.
2. **Attach the Sewer Hose to the Dump Connection** – Securely connect one end of the sewer hose to the dump station and the other end of the sewer hose to the grey water dump connection on the driver's side, in front of the rear tire.
3. **Open the Gate Valve** – Pull the gate valve handle to release the grey water waste into the sewer hose. Always ensure the valve is fully opened to allow complete drainage.
4. **Monitor the Flow** – Keep an eye on the draining process to make sure all waste is emptied efficiently.
5. **Close the Valve** – Once the tank is empty, close the gate valve completely to prevent any residual leakage and allow liquid to accumulate for the next use.
6. **Flush & Clean** – If possible, flush the tank with clean water to remove remaining residue, then detach the sewer hose.
7. **Store the Hose Safely** – Detach the sewer hose and thoroughly rinse it to remove any residue.
8. **Following these steps ensures a smooth and hygienic dumping process while maintaining the longevity of your system.**

# ***OPEN TRAIL***

## **AWNINGS, VENTS, AND DOORS**

---

### **Chapter**

# **10**

## Windows:

The Tiffin Open Trail is equipped with Nomadic Ark Argon-Filled Dual-Pane Insulated Acrylic Exterior Windows (Figure 10-1), designed to enhance thermal efficiency, durability, and overall comfort. These advanced windows feature argon gas insulation, which significantly reduces heat transfer, keeping the interior cooler in summer and warmer in winter. The dual-pane acrylic construction provides superior resistance to impact and UV exposure while maintaining a lightweight design ideal for motorhome applications. Additionally, the insulated structure minimizes outside noise, creating a quieter and more relaxing environment inside the coach. This combination of energy efficiency, durability, and sound insulation makes the Nomadic Ark windows a premium feature for travelers seeking enhanced comfort and performance on the road.



Figure 10-1: Window

Operating the Exterior Windows:

### Opening the Windows

1. **Locate the Window Latch** – Identify the locking mechanism on the window frame.
2. **Unlock the Window** – Rotate the latch to the open position.
3. **Push the Window Open** – Push the window outward.

### Closing the Windows

1. **Pull the Window Closed** – Ensure it aligns properly with the frame.
2. **Lock the Window** – Rotate the latch to the closed position.

### Maintenance & Cleaning

- **Regular Cleaning** – Use a soft cloth and non-abrasive cleaner to wipe down the acrylic surface.
- **Seal Inspection** – Periodically check the rubber seals for wear or damage.
- **Lubrication** – Apply silicone lubricant to moving parts if operation becomes stiff.

## Power Awning:

The Girard Systems power awning (Figure 10-2) comes standard on the TIFFIN Open Trail, providing users with a reliable and convenient outdoor shade solution. Engineered for durability and ease of use, this awning enhances outdoor comfort by offering protection from the sun and light weather conditions.

Designed to withstand light rain and mild wind, the awning can be safely deployed under these conditions to enhance usability and enjoyment. However, if strong winds or heavy rain are expected, or if the awning will be left unattended for an extended period, it is highly recommended to retract it to prevent potential damage. Inclement weather can place excessive stress on the awning's structure, leading to unnecessary wear or failure.

To ensure longevity and maintain optimal performance, users should follow proper operation guidelines and regularly inspect the awning for signs of wear and tear. Please note: any damage resulting from wind or rain is not covered under warranty, so taking precautionary measures to protect the awning is essential for maintaining its condition over time.

### To operate the awning (Figure 10-3):

- To OPEN the awning:
  - Press and release the "OUT" switch to fully open the awning.
  - To pause while it's moving, press and release the "STOP" switch.
- To CLOSE the awning:
  - Press and release the "IN" switch to fully retract the awning.
  - To pause while retracting, press and release the "STOP" switch.

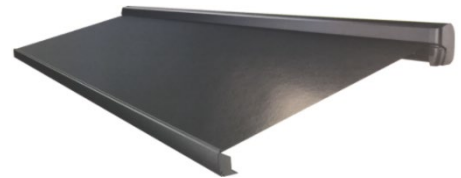

Figure 10-2: Girard Awning

Retracting the awning in the instance of power failure:

- The Girard awning has a manual override to close the awning in case of power failures.
- To use the manual override:
  - Remove the endcap opposite the motor by unscrewing the 3 Philips head screws.
  - Use a 13mm wrench to turn the square manual override shaft to close the awning.  
Note: The manual override is one-way and can only be used to close the awning.
  - Replace the endcap using the 3 Philips head screws.
- Once power is restored, the awning will resume normal operation.



Figure 10-3: Girard Awning Control

## Batwing Awning:

The Tiffin Open Trail offers an optional 270-degree batwing awning (Figure 10-4), designed to provide extended shade and protection for outdoor living. This awning wraps around the side and rear of the coach, maximizing coverage and usability in various weather conditions. Engineered for durability and ease of use, the batwing awning deploys quickly, creating a spacious sheltered area ideal for relaxation, dining, or outdoor activities. Its reinforced structure and adjustable support arms ensure stability, while the weather-resistant fabric enhances longevity. Whether parked at a campsite or off-grid, this awning option enhances the Open Trail's versatility, allowing travelers to enjoy the outdoors with added comfort and convenience.



Figure 10-4: Batwing Awning

### Deploying the Manual Awning

- **Locate the awning** – Positioned at the driver rear section of the motorhome.
- **Unzip the awning cover** – The protective cover remains permanently attached to the vehicle.
- **Release Velcro retention straps** – Allows the awning body to unfold downward.
- **Extend the awning** –
  - Pull outward from the end closest to the rear of the motorhome.
  - Continue extending until it wraps around the backside of the motorhome.
- **Insert the Awning pin** – Insert the awning pin (Figure 10-5) into the awning bracket (Figure 10-6) on the driver side and the awning bracket at the rear of the coach and tighten if needed using the adjustment strap.

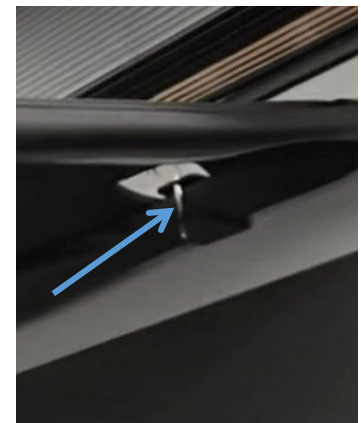

Figure 10-5: Awning Pin

### Retracting the Awning

- **Remove the pin** – Unfasten the pin from the awning bracket on both the driver side and the rear of the coach.
- **Loosen the adjustment strap if needed** – Reduce tension for easier folding.
- **Fold the awning inward** –
  - Begin by retracting it from the backside of the motorhome.
  - Continue folding until it aligns with the rear section of the vehicle.
- **Secure the awning body** – Ensure it is folded neatly.
- **Reattach Velcro retention straps** – Fasten straps to hold the awning in place.



Figure 10-6: Awning Bracket

- **Zip the awning cover closed** – Protect the awning for travel.
- **Confirm the awning is secured** – Check for proper storage before driving.

## Vents:

The roof of the TIFFIN Open Trail is equipped with a 12V DC exhaust vent fan (Figure 10-7). This fan is controlled by a three-speed switch, allowing for adjustable airflow based on user preference and environmental conditions.

To ensure optimal operation and safety, the vent fans should only be activated when the van is stationary and actively in use. Additionally, the fans will not function unless the vent is fully open, preventing unintended operation when closed. Proper use of this ventilation system helps maintain air circulation and comfort within the vehicle.



Figure 10-7:  
Exhaust Fan

# ***OPEN TRAIL***

## DRIVING YOUR OPEN TRAIL

---

### Chapter

# 11

## Driving Features:

1. **Active Distance Assist Distronic® (Adaptive Cruise Control)** - This feature maintains a safe distance from the vehicle ahead by automatically adjusting the speed of the Tiffin Open Trail. It ensures a smoother and safer driving experience, especially during long journeys or in heavy traffic.
2. **Hill Start Assist** - Prevents the vehicle from rolling backward when starting on an incline. It holds the brakes momentarily as you transition from the brake pedal to the accelerator, making uphill starts effortless.
3. **Attention Assist** - Monitors driver behavior and provides alerts if signs of drowsiness or inattention are detected. This system enhances safety by encouraging breaks when needed.
4. **Traffic Sign Assist** - Uses cameras to detect and display traffic signs, such as speed limits or no-entry signs, on the dashboard. This helps drivers stay informed and compliant with road regulations.
5. **Load Adaptive Electronic Stability Program (ESP)** - Adjusts the vehicle's stability control system based on the load being carried. This ensures optimal handling and safety, regardless of the weight or distribution of cargo.
6. **High Beam Assist** - Automatically switches between high and low beams depending on the presence of oncoming traffic or vehicles ahead. This improves visibility without causing glare for other drivers.
7. **Active Lane Keeping Assist** - Helps the driver stay within their lane by providing gentle steering corrections if unintentional lane departure is detected. This feature is particularly useful on highways and long-distance drives.
8. **Heated Leather Seats with Electronic Controls** – Adjust the seat position and temperature using electronic buttons on the side of the seat to find your ideal comfort level.
9. **Swivel Bases for Driver and Passenger Seats** – Unlock the swivel mechanism (usually a lever near the base) and rotate the seat as needed for easier access or workspace flexibility.
10. **Leather-Wrapped Steering Wheel with Integrated Controls** – Use the buttons on the steering wheel to control functions such as audio, cruise control, and hands-free phone operation without taking your hands off the wheel.
11. **Keyless Start** – With the key fob inside the vehicle, press the start button to turn the engine on or off without inserting a key.
12. **Rain Sensor for Windshield Wipers** – Activate the automatic wiper setting, and the system will detect moisture on the windshield, engaging the wipers at an appropriate speed.
13. **Automatic LED Headlights** – Keep headlights set to the "Auto" mode, and they will turn on and adjust brightness based on ambient lighting conditions.
14. **Instrument Cluster with Color Display** – View vehicle diagnostics, speed, fuel levels, and navigation guidance on the digital screen located behind the steering wheel.
15. **Parking Package with 360° View Camera** – When parking, use the 360-degree camera view displayed on the infotainment screen to see all angles around the van for safer maneuvering.
16. **Interior Rear-view Mirror** – Adjust the mirror manually for better visibility inside the cabin and rear area.

17. **Crosswind Assist** – The system automatically engages at higher speeds to stabilize the van during strong crosswinds; no manual activation is required.
18. **Driver and Passenger Airbags** – These deploy automatically in the event of a collision, providing impact protection.
19. **Blind Spot Monitoring System** – If a vehicle is in your blind spot, the system alerts you with a light on the side mirrors, helping you make safer lane changes.
20. **Emergency Call System** – In the event of a serious accident, the van automatically contacts emergency services through its built-in communication system.
21. **Smartphone Integration for Apple CarPlay® and Android™ Auto** – Connect your smartphone via USB or Bluetooth to access apps, navigation, and media directly on the infotainment screen.
22. **Mercedes-Benz MBUX Multimedia System with 10.25” Touchscreen** – Use the touchscreen to access navigation, entertainment, and vehicle settings, or use voice commands for hands-free operation.
23. **Smartphone Tray with Charging Ports** – Place your phone in the designated tray and connect it to a USB or wireless charger to keep it powered.
24. **Intelligent Navigation** – Enter your destination via the touchscreen or voice commands, and the system will provide real-time traffic updates and the best route suggestions.
25. **Powered Windows** – Use the window control buttons on the door panel to raise or lower the windows with ease.
26. **Door-mounted Driver and Passenger Assist Handles** – Grip these handles to make entry and exit easier, especially in high-ground-clearance situations.
27. **Powered Door Locks** – Lock or unlock all doors using the button on the dashboard or the key fob for convenience and security.

These advanced features collectively enhance the safety, comfort, and convenience of the Tiffin Open Trail, making it a reliable choice for both everyday use and adventurous journeys.

## Driver and Passenger Seat Controls:

The Tiffin Open Trail is equipped with premium Mercedes-Benz driver and passenger seats that feature electrical controls for enhanced comfort and adjustability. These seats allow for precise positioning, making long drives more enjoyable.

### Key Features of the Electrical Seat Controls

- **Power-adjustable seating:** Move the seat forward, backward, up, or down with the touch of a button.
- **Backrest & lumbar support:** Adjust the backrest angle and lumbar support for personalized comfort.

- Heated seats: Both driver and passenger seats come with heating functionality for added warmth in colder conditions.
- Memory function: Save preferred seat positions for quick adjustments.

## Adjusting the Seats

### 1. Locate the Seat Controls:

- The controls are on the door panel, shaped like a seat for intuitive use.
- You can adjust the seat position, backrest, headrest, and seat length.

### 2. Moving the Seat:

- Slide the seat forward or backward using the base control.
- Adjust the height by moving the control up or down.

### 3. Backrest & Headrest Adjustments:

- Tilt the backrest forward or backward for lumbar support.
- Raise or lower the headrest using the designated button.

### 4. Memory Function:

- Press M and a number (1, 2, or 3) to save your preferred seat position.
- To recall a saved position, press the corresponding number button.

## Driver & Passenger Heated Seats:

The Tiffin Open Trail Mercedes-Benz 3500XD AWD Dual Wheel is designed for comfort and convenience, especially in colder climates. One of its premium features is the heated seats, which provide warmth and relaxation for both the driver and passenger. With multiple heat settings, occupants can customize their level of comfort with the push of a button. The heated seat system ensures a cozy driving experience, making long journeys more enjoyable, whether navigating rugged terrain or cruising on the highway. Combined with Mercedes-Benz's renowned engineering, this feature enhances the luxurious feel of the vehicle, reinforcing its reputation as a top choice for adventure seekers and commercial use alike.

To operate the heated seats in the Tiffin Open Trail, follow these steps:

1. **Locate the Heated Seat Controls (Figure 11-1)** – The controls are found on the door panel
2. **Activate the Heating Function** – Press the heated seat button once to turn it on. Some models offer multiple heat levels, so pressing the button repeatedly may cycle through different intensity settings.
3. **Monitor the Indicator Lights** – The seat heating system usually has LED indicators that show the current heat level.
4. **Turn Off the Heated Seats** – Press the button again until the indicator lights turn off, or the system may automatically shut off after a set period.



Figure 11-1: Heated Seat Controls

For precise details, you can refer to the official Mercedes-Benz Sprinter Owner's Manual in your Owner's Information Package.

## Active Distance Assist:

The Tiffin Open Trail series is designed with advanced safety and convenience in mind, offering features like Active Distance Assist. This intelligent system helps drivers maintain a safe following distance from vehicles ahead by automatically adjusting speed as needed. Whether cruising on the highway or navigating busy roads, Active Distance Assist provides seamless acceleration and braking, reducing driver fatigue and enhancing overall travel comfort. With this innovative technology, Tiffin ensures a smoother and more confident driving experience, prioritizing safety without compromising performance. Here's how it works:

1. **Activate the System:** Use the steering wheel controls to turn on DISTRONIC. You can set your desired speed and preferred following distance.
2. **Adjust Distance:** The system allows you to choose from multiple distance levels to maintain a safe gap between your vehicle and the one in front.
3. **Automatic Speed Adaptation:** DISTRONIC will accelerate or brake automatically to keep pace with traffic. If you activate the turn signal to pass, the system can speed up accordingly.
4. **Stop-and-Go Functionality:** In traffic jams, DISTRONIC can bring the vehicle to a complete stop and resume movement when traffic starts moving again.
5. **Speed Limit Recognition:** If equipped, the system can detect speed limits and adjust accordingly with a button press on the steering wheel.
6. **Limitations:** The system may not function properly in poor weather conditions, such as heavy rain or snow, or if sensors are obstructed. It also has trouble detecting vehicles over steep hills or around sharp corners.

## Hazard Warning Lights:

The Tiffin Open Trail is equipped with hazard warning lights, an essential safety feature designed to alert other drivers in emergency situations. These lights help improve visibility when the vehicle is stationary due to a breakdown or other roadside emergencies.

To switch on/off: Press the Hazard Warning Lamp Switch (Figure 11-2). If you have indicated a turn while the hazard warning lamps are switched on, only the turn signal lamps on the side of the vehicle selected will light up.

The hazard warning lamps will switch on automatically if:

- An airbag is deployed.
- You brake sharply and bring the vehicle to a halt at a speed of more than 45 mph

If the hazard warning lamps have been switched on automatically, press the hazard warning lamp switch to switch them off.



Figure 11-2: Hazard Warning Light Switch

Activate the hazard warning lights whenever the vehicle is stopped on the roadside or near moving traffic. These lights signal a potential hazard to other drivers, encouraging them to take extra precautions. Once switched on, the hazard lights will continue flashing even if the key is turned off or removed from the ignition.

## Attention Assist:

Attention Assist is a safety feature on the Tiffin Open Trail Mercedes-Benz vehicles designed to detect signs of driver fatigue and alert you to take a break. Here's how it works:

1. **Activation:** The system is automatically active when you start driving. It begins analyzing your driving behavior within the first few minutes.
2. **Monitoring Driving Patterns:** Using over 70 parameters, Attention Assist tracks steering movements, reaction times, and other behaviors to determine if you're becoming drowsy.
3. **Alerts:** If the system detects signs of fatigue, it will display a coffee cup icon on the dashboard and issue an audible alert suggesting you take a break.
4. **Customization:** Some models allow you to adjust the sensitivity of Attention Assist through the vehicle's settings.
5. **Limitations:** The system works best on highways and long-distance drives but may not be as effective in city traffic or short trips.

## Traffic Sign Assist:

Traffic Sign Assist (Figure 11-3) on the Tiffin Open Trail Mercedes-Benz helps drivers stay aware of road signs by detecting and displaying them in real-time. Here's how to operate it:

1. **Activation:** The system is typically active by default. It uses a forward-facing camera and navigation data to recognize traffic signs.
2. **Display of Signs:** Detected signs, such as speed limits and no-passing zones, appear on the vehicle's dashboard.
3. **Warnings:** If you exceed a posted speed limit, the system can issue an audible and visual warning.
4. **Additional Features:** Some versions of Traffic Sign Assist can recognize stop signs, red lights, and pedestrian crossings, providing alerts to enhance safety.
5. **Limitations:** Poor visibility, unclear signage, or obstructed cameras may affect the system's accuracy.



Figure11-3: Traffic Sign Assist

## Active Lane-Keeping Assist:

Active Lane Keeping Assist in the Mercedes-Benz 3500XD AWD helps prevent unintentional lane departures by monitoring road markings and providing corrective steering or braking when necessary. Here's how to operate it:

1. **Activation:** The system is typically active by default. You can adjust its settings through the vehicle's infotainment system.

2. **Lane Monitoring:** Using a forward-facing camera, the system detects lane markings and assesses whether the vehicle is drifting unintentionally.
3. **Warnings:** If the vehicle begins to leave its lane without signaling, the system may issue a steering wheel vibration or visual alert.
4. **Corrective Action:** If necessary, the system can apply selective braking to guide the vehicle back into its lane.
5. **Overriding the System:** If you intentionally change lanes with the turn signal activated, the system will not intervene.
6. **Limitations:** Poor weather, faded lane markings, or obstructed sensors may affect performance.

You can adjust the Active Lane Keeping Assist on your Open Trail through the vehicle's settings menu. Here's how:

1. **Access the Settings Menu:** Use the home button on the steering wheel to navigate to the **Assistance** settings.
2. **Locate Lane Keeping Assist:** Scroll to the Lane Keeping Assist option.
3. **Adjust Sensitivity:** You can modify the system's intervention level—choose between early, medium, or late response.
4. **Deactivate if Needed:** If you prefer, you can turn off the feature, but it may reactivate upon restarting the vehicle.

## High Beam Assist:

High Beam Assist in the Mercedes-Benz 3500XD AWD helps optimize visibility by automatically switching between high and low beams based on surrounding traffic and lighting conditions. Here's how to operate it:

1. **Activation:** Set the rotary light switch to "Auto" and activate High Beam Assist using the control lever on the steering wheel.
2. **Automatic Adjustments:** The system detects oncoming vehicles and vehicles ahead using a camera. If no other road users are detected, high beams will activate automatically.
3. **Deactivation:** High beams will switch to low beams when another vehicle is detected, when driving at lower speeds, or if there is sufficient street lighting.
4. **Limitations:** The system may not react to pedestrians, cyclists, or poorly lit objects. Weather conditions and sensor obstructions can also affect performance.

## Side View Cameras:

The side view cameras on the Tiffin Open Trail are part of the 360-degree surround view system, designed to enhance visibility and assist with parking and maneuvering. Here's how to use them:

### Activating the Side View Cameras

- The system automatically engages when you shift into reverse, displaying a bird's-eye view on the infotainment screen.

- You can also manually activate the cameras via the infotainment system.

### Using the Cameras for Parking & Maneuvering

- The side cameras help reduce blind spots, especially when navigating tight spaces.
- The display adjusts dynamically, showing different angles depending on your steering input and proximity to obstacles.
- If your vehicle has guidelines, they will appear on the screen to assist with alignment.

### Adjusting Camera Settings

- You can customize the camera views through the vehicle's settings menu.
  - Navigate to the MBUX infotainment system.
  - Select Vehicle Settings and then Camera & Parking Assist.
  - You can switch between front, rear, and side views.
  - Some models allow zooming in or adjusting the angle for better visibility.
  - Toggle parking guidelines on or off to assist with alignment.
  - Adjust Brightness & Contrast:
  - Modify display settings for better visibility in different lighting conditions.

### Audio System:

The Tiffin Open Trail is equipped with the audio system (Figure 11-4), designed to provide high-quality sound and seamless connectivity for an enhanced driving experience. This system integrates advanced features such as Bluetooth pairing, voice control, and premium speaker output, ensuring clear audio whether you're listening to music, navigation prompts, or hands-free calls.



Figure 11-4: Audio System

### How to Use the Audio System

#### 1. Powering On & Basic Controls

- Press the power button on the dashboard or infotainment screen to activate the system.
- Use the volume knob or steering wheel controls to adjust sound levels.

#### 2. Connecting via Bluetooth

- Enable Bluetooth on your smartphone.
- Access the Audio System Menu – Navigate to the Bluetooth settings on the infotainment screen.
- Select “Pair New Device” – Choose your phone from the list of available devices.
- Confirm Pairing – Accept the connection request on both your phone and the vehicle's system.
- Verify Connection – Once paired, you can stream music, make calls, and use voice commands.

#### 3. Using Voice Control

- Press the voice command button on the steering wheel.

- Say a command such as “Play music”, “Call [contact name]”, or “Navigate to [destination]”.
- Follow on-screen prompts if needed.

#### 4. Adjusting Audio Settings

- Navigate to the sound settings in the infotainment menu.
- Customize bass, treble, balance, and fade for optimal sound quality.
- Select audio presets for different listening preferences.

#### 5. Switching Between Audio Sources

- Use the source button to toggle between FM/AM radio, Bluetooth, USB, and auxiliary input.
- Select your preferred source from the infotainment screen.

### Dashboard Climate Control:

1. **Adjusting Temperature** – Locate the climate control panel (Figure 11-5), positioned on the dashboard. Use the temperature dial controls to set the desired cabin temperature. If equipped with dual-zone climate control, you can independently adjust settings for the driver and passenger sides.
2. **Selecting Airflow Mode** – Choose where you want the air to be directed by using the airflow settings. Options include front-facing vents, foot-level vents, defrost for the windshield, or a combination of these.
3. **Controlling Fan Speed** – Adjust the blower speed using the fan control buttons. Increasing the fan speed will circulate air more rapidly, while lower settings provide a gentle airflow.
4. **Activating Air Conditioning (A/C)** – Press the A/C button to engage the air conditioning system, which cools the cabin by removing humidity and lowering the temperature. This function works best with windows closed to maintain efficiency.
5. **Using the Heating System** – For cold weather, adjust the temperature dial towards the hot setting. This will activate the van’s heating system, warming the interior using engine-generated heat.
6. **Defrosting Windows** – If windows fog up, press the defrost button to direct warm air toward the windshield and side windows, clearing condensation for better visibility.
7. **Recirculating Air** – To keep cabin air circulating without bringing in outside air, press the recirculation button. This is useful for maintaining interior temperatures and reducing external pollutants from entering.



Figure 11-5: Dashboard Climate Control Panel

The dash air conditioner and heater in the Tiffin Open Trail are designed to regulate the climate within the cab area, rather than the entire interior. While they efficiently provide cooling and heating for the front occupants, they are not intended to control the temperature in the full cargo space or passenger area. Additionally, regardless of the selected mode settings, a small amount of airflow will continue to be emitted from the defrost and dash vents, ensuring a continuous circulation of air.

The Premium Mercedes Driver & Passenger Seats in the Mercedes-Benz® 3500XD AWD Dual Wheel Cutaway Chassis feature electrical controls for precise, effortless adjustments, along with heated seating for enhanced comfort in colder conditions.

# ***OPEN TRAIL***

## **MAINTENANCE WASHING AND DRYING**

---

### **Chapter**

# **12**

## Washing:

To hand-wash your TIFFIN Open Trail, follow these guidelines:

1. **Use a mild cleaning agent, such as car shampoo, along with lukewarm water and a soft car sponge. Avoid exposing the vehicle to direct sunlight during cleaning.**
2. **Rinse the vehicle thoroughly with water, taking care not to aim the water jet directly at the air inlet grilles. Ensure the blower is switched off during this process.**
3. **Dry the vehicle using a leather cloth to prevent water spots. Do not allow the cleaning agent to dry on the paintwork.**
4. **At the start of winter, promptly and thoroughly remove all road salt deposits to protect the vehicle's surface.**

For more detailed instructions on washing your TIFFIN Open Trail, consult the Mercedes-Benz Sprinter manual.

## Seals:

The seals around the doors, windows, vents, and external seams should be checked at least semi-annually.

If deterioration is noted during a routine maintenance inspection, reseal the seams or seals with an approved sealant to prevent leaks.

Your TIFFIN Open Trail dealer can perform resealing inspections and subsequent work for you. It is recommended that a TIFFIN Open Trail authorized service center perform these inspections periodically and perform the necessary resealing as required.

## Proper Sealants For Application:

The following sealants are recommended for specific applications, as noted in the table. These can be purchased through TIFFIN Motorhomes parts and service department by calling 205-487-4710.

<b>Recommended Sealants For Specific Sealing Applications</b>	
<b>SEALANT</b>	<b>APPLICATION</b>
Plas-T-Code	Metal or Fiberglass Roof
Surebond #SB-140	Rubber Laminated to Metal Roof and All Skylights
Carlisle #502 LSW Self Leveling Sealant	Rubber Roof Over Wood Base
Silicone Sealant	Cover Butyl and Other Sealants
Parbond	Seal Across Tops Of Windows on Exterior Surfaces Where Silicone Is Not Used

## Roof Care & Maintenance:

Proper care and maintenance of your Open Trail including your roof is important for sustained trouble-free performance. Normal maintenance is simple and easy and does not require special materials.

The roof of the Open Trail is metal and can be cared for in the conventional manner. Clean the roof at least every three months. The roof should be professionally inspected by a dealer annually.

## Moisture Maintenance:

This section outlines important recommendations to manage moisture in your Open Trail to avoid moisture related damage such as mold. The materials and methods used to construct your Open Trail were selected in part to minimize air leakage and to create a weather tight exterior shell.

However, in order to protect your investment and reduce the risk of moisture related damage and costly repairs, attention and care has to be taken to manage moisture inside of your Open Trail.

**NOTE:** These are only suggestions intended to minimize moisture related issues with your Open Trail. If any concerns arise, contact Tiffin Motorhomes' Service Department

## Interior Care:

Signs of excessive moisture can be obvious, such as water droplets forming on surfaces or wet carpet. Conversely, signs of excess moisture can be subtle, such as condensation forming on metal surfaces.

When symptoms appear, it is important to immediately determine the cause of the excess moisture and take appropriate corrective action to prevent moisture related damage.

## Condensation:

### **NOTICE**

**Use only RV odor-controlling chemicals in the holding tanks. Products containing ammonia and petroleum will damage the ABS plastic holding tanks and seals.**

Damage may occur to your vehicle if excessive condensation exists. Accumulation of condensation on surfaces within your Open Trail occurs when warm, moist air contacts a cool surface. It is most evident on the inside of windows, but this problem can be controlled by:

Slightly opening a window or roof vent to allow the moisture to escape from the motor home.

A small dehumidifier is also very effective in removing moisture from the air.

## Fabrics:

The fabrics used in the Tiffin Open Trail for the bedspread contain fire retardant additives that may be damaged by use of improper cleaning products. Cleaning instructions for these items are "DRY CLEAN ONLY".

Water based products are not recommended for cleaning the fabrics in your Open Trail. Most water-based household cleaning products are not formulated for use on these fabrics and may cause excessive shrinkage or fading.

For best results, the fabrics in your Open Trail should be cleaned by a professional carpet and upholstery cleaner.

Spills, spots or stains should be treated as soon as possible to avoid permanent damage to the fabrics. If a spill occurs, blot the fluid with a dry towel, do not rub the spill as rubbing may cause the liquid to "set" in the fabric and cause a stain.

While attempting to clean a spot or stain, always start from the outside and work inward to avoid spreading the stain further. Some stains or soils are extremely difficult or impossible to totally remove. These stains should receive immediate professional attention.

Spills, spots, stains or soiled areas are the responsibility of the owner and are not covered by the TIFFIN Open Trail Motorhomes Limited Warranty.

## Walls & Ceiling:

The wall and ceiling coverings should be cleaned periodically to maintain a new appearance. Use a nonabrasive cleaner with a soft cloth on the walls. Do not use solvents of any kind, as those solvents may damage the surfaces being cleaned.

## Dashboard:

To keep the Open Trail dashboard in like-new condition, regularly follow these guidelines:

DO:

Dust and clean the dashboard with a soft, damp cloth or chamois, wiping the surface gently

Use a mild detergent and lukewarm water

After washing and rinsing the dashboard, dry it by blotting with a damp cloth

DO NOT:

Use harsh chemicals that may damage the dashboard

Use cloths containing grit or abrasive particles or kitchen scouring compounds to clean or dust the dashboard

Subject the dashboard to hard, direct blows

Use boiled water, strong solvents, or other such materials to clean the dashboard, as they will soften the plastic

## Woodwork & Floors:

The wood cabinetry should be cared for with furniture polish to sustain the natural beauty and luster of the wood. This procedure will also keep the cabinetry looking new, prevent the wood from drying and reduce chances of accidental staining or aging.

Use area rugs and floor mats by the side entrance door to trap dirt.

Use soap and water to clean the flooring, begin by vacuuming the floor to remove loose dust and dirt. Then, damp mop the floor with a standard cleaning solution. The mop should be damp but not dripping.

To remove stubborn spots like shoe polish, oil, tar, markers, scuffs and the like; use a household solvent or nail polish remover on those spots then wipe those treated areas with a damp cloth.

To remove chocolate, grease, juice or wine, use warm water and any off the shelf abrasive cleaner. To remove candle wax or chewing gum, carefully scrape off when the material has hardened. For further tips, please see the manufacturer's information sheet in your TIFFIN Open Trail Owner Information Package.

## Countertops:

To care properly for the countertops in your Open Trail, always use a heat pad or trivet to protect the surface from hot objects that may mar or damage the countertop surface. Hot pans and heat producing appliances (such as electric skillets), when set directly on top of the countertop, can possibly mar the beauty and finish of the product.

Additionally, since heat producing appliances can also damage the countertop seams, it is essential to check with TIFFIN Open Trail Motorhomes to identify seam locations to avoid them during subsequent use of the motorhome.

Although solid surfacing is repaired easily, certain steps should be taken to protect it. Be sure to use a cutting board rather than cutting an item directly on the countertop surface. Although minor scratches and cuts can be repaired a little care will assure that the countertop surface will keep looking new for years.

Do not expose the surface to harsh chemicals such as paint remover, turpentine, nail polish remover or any stove and drain cleaners. If these chemicals should come into contact with the countertop surface, immediately wash off these chemicals, using appropriate safety to avoid injury.

## Accessories:

The metallic light fixtures, bath accessories and faucets can be cleaned by wiping with a soft, damp cloth. Washing with warm water will remove dry water spots. Polishing those fixtures with a soft cloth will also enhance the appearance.

Do not use cleaners that contain harsh or abrasive chemicals. Alcohol or other similar solvents should never be used either.

## Detectors:

The CO propane gas detectors are self-contained and DO NOT require any maintenance other than normal cleaning and periodic testing. The smoke detector installed in your Open Trail is a nine-volt, battery operated detector.

The CO gas detector is wired directly to the house batteries. The batteries in the smoke detector need to be tested periodically and replaced when necessary. When cleaning the case use a damp cloth or paper towel.

DO NOT spray cleaners or wax directly into the detectors case as this action may cause false alarms or hinder the normal operation of the detectors.

An inexpensive battery detector tester would be a good investment to make. This tester would allow checking of the batteries in the various alarms; any flashlights used in the Open Trail and batteries in other appliances which may be in the Open Trail during travels.

### Routine Maintenance Schedules:

<b>NOTICE</b>
<b>Always follow the chassis maintenance guidelines found in the chassis manufacturer's manual.</b>

All routine maintenance is the responsibility of the owner and is not covered by the TIFFIN Open Trail Limited Warranty. Use the maintenance record found in Chapter 13 to record all performed maintenance as required.

Please note that any damage caused by improper or unperformed maintenance is not covered by the TIFFIN Open Trail Motorhomes Limited Warranty. Items supplied by other manufacturers may require specific individual maintenance not listed herein. Please refer to the manufacturers' suggested maintenance guidelines in the Owners Information Package.

<b>NOTICE</b>
<b>Cosmetic adjustments and alignments must be performed within the first three months from date of original purchase for warranty consideration. Thereafter, these items are considered routine maintenance.</b>

#### MONTHLY:

- Check the water levels of the batteries

#### EVERY THREE MONTHS:

- Test smoke alarm and carbon monoxide/LP gas detector.
- Check operation of windows, latches, and hinges.
- Clean the roof ducted air conditioner filter or filters.
- Clean and inspect door and window seals; reseal where necessary.

- Inspect and reseal around the tub and shower area where necessary.
- Lubricate the exterior door hinges and latches with a graphite (silicone) lubricant.
- Check, clean, and tighten battery cables and inspect batteries for proper fluid levels.

#### EVERY SIX MONTHS:

- Change the battery in the smoke detector.
- Rotate tires as recommended by the tire manufacturer.
- Check all gas appliances for proper operation.
- Change the batteries in both the smoke detector

#### ANNUALLY:

- Inspection of roof seams and joints should be performed by an authorized Motorhomes Service Center. If resealing is necessary, it is the owner's responsibility and is not covered by the TIFFIN Open Trail Limited warranty.
- Sanitize the freshwater system.

### Winterizing:

To store your vehicle for the winter months, it is necessary to winterize the water system to help prevent freezing of this system. To do this, follow these instructions:

Drain all the water from the water system including the holding tank(s) and freshwater tank. Also, drain the water filter. For the holding tank(s), open the gate valve(s) to drain the tanks.

**NOTE:** This procedure is to be performed only at a wastewater pumping station to prevent dumping of contaminated water elsewhere. For the water tank, open the red-handled valve to drain the tank; then close the valve. Remove the filter cartridge from the water filter and store it in a clean environment. Empty any excess water from the filter housing and replace the housing.

At the sewer board turn the blue handle valve to the sanitize/winterize position turn the red handle valve to the bypass position.

Connect a vinyl hose to the inlet valve on the sewer board place the other end of the hose into a gallon of freshwater system antifreeze. **NOTE:** Do not use automotive antifreeze; use only antifreeze approved for RV applications. Otherwise, damage to the systems being protected may result.

Turn "on" the water pump to start the flow of antifreeze. Turn "on" each faucet, one at a time, including the kitchen faucet, bath faucet, inside and outside showers and allow pure antifreeze to run through that piping. Let about one cup drop into the drains to protect the traps.

When all the antifreeze is withdrawn from the bottle, disconnect the vinyl hose from the inlet valve on the sewer board. (This may require more than one gallon of antifreeze).

When the winterize process is completed, turn the water pump "off". Store the vinyl hose for future use.

## De-Winterizing:

To de-winterize your vehicle, open both of the low point drains to allow the antifreeze solution to drain from the water system.

Next, close the low point drains and connect your vehicle to the city water system. Put water in the freshwater tank and pump at least one gallon through the water pump to remove the antifreeze from the water pump.

As in winterizing, open the kitchen faucet, bath faucet, inside and outside showers, turning “on” both the hot- and the cold-water valves and flushing the stool until the antifreeze solution is flushed out of the system and the water flow is clear.

Open the freshwater tank supply valve from the pump.

Be sure to close the freshwater tank drain valves to allow the tank to fill.

## Tire & Safety Information:

This portion of the Owner’s Manual contains tire safety information as required by 49 CFR 575.6. The National Traffic Safety Administration (NHTSA) can be contacted at 1-888-327-4236. Their web site is <http://www.safecar.gov> and their address is: NHTSA, 400 Seventh St, S.W., Washington, D.C. 20590.

The National Traffic Safety (NHTSA) has published a brochure (DOT HS 809 361) that discusses all aspects of Tire Safety, as required by CFR 575.6. This brochure is reproduced in part below. It can be obtained and downloaded from NHTSA, free of charge, from the following web site:

<http://www.nhtsa.dot.gov/cars/rules/TireSafety/ridesonit/tires index.html>

Studies of tire safety show that maintaining proper tire pressure, observing tire and vehicle load limits, avoiding road hazards, and inspecting tires for cuts, slashes, and other irregularities are the most important things you can do to avoid tire failure, such as tread separation or blowout and flat tires. These actions, along with other care and maintenance activities, can also:

- Improve vehicle handling
- Help protect you and others from avoidable breakdowns and accidents
- Improve fuel economy
- Increase the life of your tires

This section presents a comprehensive overview of tire safety, including information on the following topics:

- Basic tire maintenance
- Uniform Tire Quality Grading System



### CAUTION

**Do not use harsh detergents, acids, abrasives which may scratch or dull the surfaces. The applicator cloth, sponge, or soft-bristled brush should be non-metallic and non-abrasive. Also, remember to check the tightness of the wheel lug nuts frequently.**

- Fundamental characteristics of tires
- Tire safety tips

Use this information to make tire safety a regular part of your vehicle maintenance routine. Recognize that the time you spend is minimal compared with the inconvenience and safety consequences of a flat tire or other tire failure.

## Safety First Basic Tire Maintenance:

Properly maintained tires improve the steering, stopping, traction, and load carrying capability of your Open Trail. Under-inflated tires and overloaded vehicles are a major cause of tire failure. Therefore, as mentioned above; to avoid flat tires and other types of tire failure, you should maintain proper tire pressure, observe tire and vehicle load limits, avoid road hazards and regularly inspect your tires.

## Finding Your Van's Recommended Tire Pressure and Load Limits:

Tire information placards and vehicle certification labels contain information on tires and load limits. These labels indicate the vehicle manufacturer's information including:

- Recommended tire size
- Recommended tire inflation pressure
- Vehicle capacity weight (VCW – the maximum occupant and cargo weight a Van is designed to carry.)
- Front and rear gross axle weight ratings (GAWR – the maximum weight the axle systems are designed to carry).

## Understanding Tire Pressure and Load Limits:

Tire inflation pressure is the level of air in the tire that provides it with load carrying capacity and affects the overall performance of the Open Trail. The tire inflation pressure is a number that indicates the amount of air pressure - measured in pounds per square inch (PSI) - a tire requires to be properly inflated. (You will also find this number on the Open Trail information placard expressed in kilopascals (kPa), which is the metric measure used internationally).

Because tires are designed to be used on more than one type of vehicle, tire manufacturers list the "maximum permissible inflation pressure" on the tire sidewall. This number is the greatest amount of air pressure that should ever be put in the tire under normal driving conditions.

## Checking Tire Pressure:

It is important to check your vehicle's tire pressure at least once a month for the following reasons:

Most tires may naturally lose air over time

Tires can lose air suddenly if you drive over a pothole or other object or if you strike the curb when parking

With radial tires, it is usually not possible to determine under-inflation by visual inspection for convenience, purchase a tire pressure gauge to keep in your vehicle. Gauges can be purchased at tire dealerships, auto supply stores, and other retail outlets.

The recommended tire inflation pressure that vehicle manufacturers provide reflects the proper psi when a tire is cold. The term cold does not relate to the outside temperature. Rather, a cold tire is one that has not been driven on for at least three hours. When you drive, your tires get warmer, causing the air pressure within them to increase. Therefore, to get an accurate tire pressure reading, you must measure tire pressure when the tires are cold or compensate for the extra pressure in warm tires.

## Steps For Maintaining Proper Tire Pressure:

1. **Locate the recommended tire pressure on the vehicle's tire information placard, certification label, or in the owner's manual**
2. **Record the tire pressure of all tires**
3. **If the tire pressure is too high in any of the tires, slowly release air by gently pressing on the tire valve stem with the edge of your tire gauge until you get to the correct pressure •**
4. **If the tire pressure is too low, note the difference between the measured tire pressure and correct tire pressure. These "missing" pounds of pressure are what you will need to add •**
5. **At a service station, add the missing pounds of air pressure to each tire that is under inflated**
6. **Check all the tires to make sure they have the same air pressure (except in cases in which the front and rear tires are supposed to have different amounts of pressure)**

If you have been driving your vehicle and think that a tire is under-inflated, fill it to the recommended cold inflation pressure indicated on your vehicle's tire information placard of certification label.

While your tire may still be slightly under-inflated due to the extra pounds of pressure in the warm tire, it is safer to drive with air pressure that is slightly lower than the vehicle manufacturer's recommended cold inflation pressure than to drive with a significantly under-inflated tire.

Since this is a temporary fix, don't forget to recheck and adjust the tire's pressure when you can obtain a cold temperature reading.

## Tire Size:

To maintain tire safety, purchase new tires that are the same size as the Open Trails original tires or another size recommended by the chassis manufacturer.

Look at the tire information placard, the owner's manual or the sidewall of the tire you are replacing to find this information. If you have any doubt about the correct size to choose, consult with a tire dealer.

## Tire Tread:

The tire tread provides the gripping action and traction that prevents your Open Trail from slipping and sliding, especially when the road is wet or icy. In general, tires are not safe and should be replaced when the tread is worn down to 1/16 of an inch. Tires have built in tread wear indicators that let you know when it is time to replace your tires.



The image above provides an example summary of the sidewall markings on passenger vehicle tires.

For specific information regarding the tires on your Open Trail refer to the tire manufacturer's manual which is located in your Owners Information Package.

## Vehicle Load Limits:

Determining the load limits of an Open Trail includes more than understanding the load limits of the tires alone. On the unit, there is a federal certification label that is affixed in the rear closet.

The certification label will indicate the Open Trails gross vehicle weight rating (GVWR). This is the most weight the fully loaded vehicle can weigh. It will also provide the gross axle weight rating (GAWR).

## Cargo Capacities:

For Open Trails, cargo can be added to the vehicle, up to the maximum weight specified on the placard. For motorized vehicles, the combined weight of passengers and cargo is provided as a single number. If fewer people are traveling, more cargo can be added.

If more people are involved, the weight of cargo must be reduced. In any case, remember: the total weight of a fully loaded vehicle, including passengers is not recommended to exceed the (GVWR).

Understanding this flexibility will allow you to make choices that fit your travel and camping needs. When loading your cargo, be sure it is distributed evenly to prevent overloading front to back and side to side.

Heavy items should be placed low as close to the axles positions as allowed. Too many items on one side may overload a tire.

The best way to know the actual weight of the Open Trail is to weigh it at a certified public scale. Talk to your RV dealer to discuss the weighing methods needed to determine the various weights related to the Open Trail. This would include weights for the following: axles, wheels, hitch and total weight.

## How Overloading Affects Your Open Trail and Tires:

The results of overloading can have serious consequences for passenger safety. Too much weight on your Open Trails suspension system can cause:

- Spring issues
- Shock absorber issues
- Brake failure
- Handling or steering problems
- Irregular tire wear
- Tire failure
- Other serious damage

## Tire Safety Tips:

Preventing tire damage:

Slow down if you have to go over a pothole or other objects in the road

Do not run over curbs or other foreign objects in the roadway, and try not to strike the curb when turning corners or when parking

Tire safety checklist:

Check the tire pressure regularly (at least once a month), this check should also include the spare tire

Inspect tires for uneven wear pattern on the tread, cracks, foreign objects or other signs of wear or trauma

Remove bits of glass or foreign objects wedged in the tire tread. (Use caution when removing such debris as to not cause personal injury).

Make sure your tire valves have valve caps

Check tire pressure before, during, and after a long trip

DO NOT overload your vehicle. Check the tire information and loading placard or tire manufacturer's owner's manual for the maximum recommended load for the Open Trail.

## Tire Pressure:

Correct tire inflation pressure is essential to maximizing the life of your tires and assuring the safety of the Open Trail and its occupants. Driving with tires that are not correctly inflated for the load of the Open Trail is dangerous and may cause premature wear, tire damage and/or loss of control of the motorhome.

An under inflated tire will build up excessive heat that may actually approach the vulcanization temperature of the rubber and lead to tread separation and/or disintegration of the tire.

Under inflated tires will also cause poor handling of the Open Trail, rapid and/or irregular tire wear and an increase in rolling resistance of the Open Trail which, in turn produces a decrease in fuel economy of operation.

An over inflated tire will reduce the tire's "footprint" (i.e., its actual contact with the road); thus, reducing traction, braking capacity and handling of the Open Trail.

A tire that is over inflated for the load that it is carrying will also contribute to a harsh ride, uneven tire wear and the tire itself will be more susceptible to impact damage.

Maintaining correct tire pressure for each loaded wheel position on the Open Trail is critically important and must be a part of regular Open Trail maintenance.

## Frequency of Checking Tire Inflation Pressures:

When you have determined the "correct" tire inflation pressures for each of the Open Trail tires and inflated the tires under "cold" conditions, meaning the tires haven't been driven for more than one mile, then the air pressures in the tires should be periodically checked to make sure that they keep their proper pressure.

It is recommended that tire pressures be checked at least once a month or preferably every two weeks and before any major trip.

On long trips, the tires should be checked every "drive" morning. On short trips (a day or less), the tires should be checked before one departs on the trip and again before one returns home.

Check tire pressures when they are "cold"; that is tires haven't been driven at all or at most, less than one mile before being measured. In this manner, the tire pressure has not been increased by the heating associated with tire sidewall and tread flexure associated with traveling.

If you check tires that are warm or hot, remember that they will necessarily read higher than normal. Do not "bleed" these tires down to "cold pressure" readings as they will probably be under inflated when they are actually cool. Do not make any adjustments to tire pressures when the tires are warm or hot, if such can be avoided.

To make these tire pressure measurements, it is recommended that you purchase a high quality, truck tire air gauge which has an angled dual head. This type of gauge allows you to check inflation pressures of both the inner dual wheel which has the valve stem pointing towards one and on the outer wheel which has the valve stem pointing away from one. Pressure sealing valve caps should always be used to protect the valve stems and prevent air from escaping from the valve stems.

### **Tire Wear, Balance, and Wheel Alignment:**

In addition to tire inflation considerations, the tires should also be periodically examined for other types of normal "wear and tear". If installed and maintained properly, all tires mounted on the Open Trail should wear in a smooth and even pattern.

If the tires begin to show irregular wear patterns and the Open Trail alignment is still correct, then sometimes having the tires rotated and changing their wheel position will allow the tires to wear evenly. Check the chassis manufacturer (Mercedes Benz) and its literature in the Owners Information Package for particulars on maintaining proper wheel alignment.

### **Tire Cleaning:**

Proper cleaning of the tires will assure maximum years of service. A soft brush and a normal mild soap should be used to clean the tires. Use care in applying any tire "dressing" product as these contain petroleum derivatives, alcohol or silicones which may cause deterioration of the rubber. This could lead to cracking and accelerate the aging process. In many instances it isn't the actual dressing itself, but the reaction of the product with the antioxidant in the tire. Heat can compound this problem also.

# ***OPEN TRAIL***

## **MAINTENANCE & DATA CHART**

---

### **Chapter**

# **13**









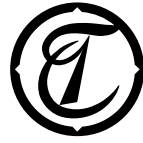

# TIFFIN

MOTORHOMES

Tiffin Motor Homes, Inc. | 105 2nd St. NW | Red Bay, AL 35582

**[tiffinmotorhomes.com](http://tiffinmotorhomes.com)**

Phone: 256-356-8661 | Email: [customersupport@tiffinmotorhomes.com](mailto:customersupport@tiffinmotorhomes.com)

To view or download a full color, printable version of this owner's manual, visit

[www.tiffinmotorhomes.com/resources/owners-manual](http://www.tiffinmotorhomes.com/resources/owners-manual)

OR SCAN BELOW

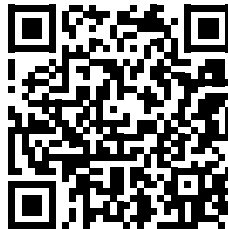

Because of progressive improvements and specifications, standard and optional equipment are subject to change without notice or obligation. For a complete and up-to-date list of available options and specifications, visit [tiffinMotorHomes.com](http://tiffinMotorHomes.com).

All trademarks and logos are owned or used under license by Tiffin Motor Homes, Inc. and include, but are not limited to: Tiffin®, Many Adventures. One Dream.™, Allegro®, Allegro Breeze®, Allegro RED®, Phaeton®, Allegro Bus®, Zephyr®, Wayfarer®, Roughing It Smoothly®, Open Road®, PowerGlide®, Cahaba®, Byway™, Convoy™, Bronze™, and associated logos and emblems. Unauthorized use of any trademark of Tiffin Motor Homes, Inc. is strictly prohibited. P/N: 5163989

© Copyright 2025 Tiffin Motor Homes, Inc.