

TIFFIN

MOTORHOMES

2024 Owner's Manual





TIFFIN

MOTORHOMES

DISCLAIMER

Many of the features and appliances described in this manual might not be reflected in the actual motorhome purchased, depending on the options and models selected by the motorhome owner. All items, materials, instructions, and guidance described in this manual are as accurate as possible at the time of printing. However, due to Tiffin Motorhomes' ongoing and dedicated commitment to excellence, improvement of Tiffin's motorhomes is a continuing process. Consequently, Tiffin Motorhomes reserves the right to make substitutions and improvements in its makes and models of motorhomes without prior notification. Substitutions of comparable or better materials, finishes, appliances, instrumentation, and instruction might be made at any time it is deemed prudent to provide the customer with the best possible motorhome, meeting the customer's requirements.

Copyright © by Tiffin Motorhomes, Inc. - all rights reserved

Tiffin Motorhomes, Inc.
105 2nd St. NW
Red Bay, AL 35582
Phone: 256-356-8661

Fax: 256-356-8219

Email: customersupport@tiffinmotorhomes.com

www.tiffinmotorhomes.com



TIFFIN

Many Adventures. One Dream.™



There are many ways to adventure in our products, but all customers share a similar dream of leisure, exploration, and fun while making lifelong memories with the most important people in their lives.

Our products are the vehicle for customer's adventures and helping them realize their dreams.

TABLE OF CONTENTS

1 General Information	1
Welcome to a life of “roughing it smoothly”	2
About This Manual	2
Delivery.....	3
Dealer Responsibilities	3
Customer Responsibilities	3
Reporting Safety Defects (USA).....	4
Reporting Safety Defects (Canada)	4
Signalement Des Defauts De Securite A Transport Canada Pour Les Proprietaies Canadiens.....	5
Tiffin Motorhomes Limited Warranty	5
Major Equipment Manufacturers.....	6
Warranty Service	6
Owner’s Information Package.....	6
Customer Relations.....	7
Specification Labels	7
Weighing Procedures	9
Weight Distribution	9
Safety Messages	10
2 Safety Instructions	11
Safety Considerations	12
General Warnings	12
Pre-Departure Checklist.....	13
Driving Safety	14
Fuels for the Motorhome	15
Liquid Propane (LP) Gas System.....	16
LP Gas Regulator	18
LP Distribution System.....	18
Recommended Practices	19
Carbon Monoxide Warning	19
CO/LP Gas Detector	20
Fire Safety	22
Fire Extinguisher	22
Smoke Detector	23
Electrical	23
Loading.....	23
Maintenance.....	23
Emergency Exits	24
Parking Procedures	24
Towing Hitch	25

TABLE OF CONTENTS

3 Heating & Air Conditioning	26
Furnace	27
Air Conditioning System.....	28
Thermostat Controls System	29
4 LPGas System.....	31
Liquid Propane (LP) Tank.....	32
LP Tank Filling And Monitoring	33
LP Gas Regulator	33
5 Major Appliances	35
Residential Refrigerator.....	36
Ice Maker.....	36
Microwave Oven.....	37
Air Filtration Fan	38
Optional Oven and/or Optional Cooktop	39
Water Heater	41
LP Gas – Electronic Ignition Operation	42
120 volt AC Electrical Operation.....	42
Water Heater Storage	42
Pressure Relief Valve.....	43
6 ENTERTAINMENTS	44
Television Antenna	45
Television Satellite Dish (Optional)	45
Television Sets.....	46
Infrared Repeater	47
Blu-ray Player	47
7 Cabinets & Furniture	48
Cabinets	49
Furniture.....	51
Kitchen, Living & Dining Areas	51
Bedroom Area	52
8 Structural Features	53
Chassis Features.....	54

TABLE OF CONTENTS

9 Electrical Features	55
General Information	56
Spyder Controls System.....	57
Multiplex System.....	58
Wifi Antenna (Optional)	58
Electrical Cautions.....	59
Circuit Breaker Boxes	59
120 Volt (VAC) AC Receptacles	60
Ground-Fault-Circuit-Interrupt Receptacles	61
Converter/Inverter	61
Electrical Generator.....	63
Automatic Transfer Switch	63
Circuit Breakers	64
12 Volt DC (VDC) Receptacles	65
USB Receptacles	65
Battery Inspection and Care	66
House Battery Disconnect Panel	68
Engine Battery Disconnect Panel	68
12 Volt DC Disconnect Switch	69
Auxiliary Start Switch	69
Seven-Pin Towing Connector	69
Solar Pre Wired.....	70
Electrical Diagram	71
33AL.....	71
10 Slide-Out Features	72
Slide-Out Overview.....	73
General Considerations.....	73
Operating Precautions	74
Extending the Slide-Out Room	74
Retracting the Slide-Out Room	75
Emergency Slide-Out Room Control Override.....	76
11 Exterior Features	77
Towing Hitch	78
Exterior Sides.....	78
Security Lights	79
Roof & Ladder (Optional)	79
Electric Steps.....	80
Using the Electrical, Double-Entrance, Door Steps	80
Mirrors	82

TABLE OF CONTENTS

12 Interior Features.....	83
Bedsread	84
Flooring.....	84
Ceiling/Lighting	84
Window Treatments	85
ELEVATED BEDS CAUTION.	85
13 Plumbing & Bath Features	87
Tank-Level Monitor	88
Kitchen Sink.....	88
Bathroom Sink, Shower, & Accessories	89
Showermiser	89
Water Pump	90
City Water Connection	91
Filling the Freshwater Tank.....	91
Water Filter.....	92
Sanitizing.....	92
Water Heater Bypass System	93
Freshwater Lines	93
Wastewater General Information.....	94
Toilet	94
Black-Water Holding Tank	95
Gray-Water Holding Tank	95
P-Traps	95
Wastewater Disposal	96
Sewer Connection and Camping.....	96
No Fuss Flush	97
Exterior Shower	97
Plumbing Diagram	98
33AL.....	98
14 Windows, Awnings, Vents, & Doors	100
Windows	101
Awnings.....	101
Vents	104
Doors	104
15 Driving Your Motorhome.....	105
Ecomaster Camera System.....	106
Basic Rear View Camera Operation.....	106
Roadwatch	106

TABLE OF CONTENTS

Side-Mount Camera	107
CB Radio System Antenna Connection	107
AM/FM/CD Stereo System	107
Dashboard Heating/Cooling Controls	108
Automatic Transmission Controls	108
Tire PRESSURE Monitoring System	108
Automatic Levelling System	108
16 Routine Maintenance	109
Washing	110
Seals	111
Proper Sealants for Application	111
Wheel Care	112
Roof Care & Maintenance	112
Moisture Management.....	113
Interior Care of Your RV	113
Control Relative Humidity	113
Avoid Drastic Thermostat Setbacks	113
Manage Window Condensation	114
Carpet Care and Moisture Management	114
Cleaning Tile and Wood Floors.....	114
Storage and Other Isolated Areas within the RV.....	114
Use of Un-Vented Combustion Equipment.....	114
Exterior Care of Your RV	115
Use of Your RV	115
Severe Environments	115
Storage of Your RV	115
Modifications to Your RV	116
Wet Areas	116
Tire & Safety Information	116
Section One	116
Section Two.....	124
Section Three	124
Tire Pressure	127
Interior Care	131
Fabrics.....	132
Walls & Ceiling	133
Dashboard	133
Woodwork & Floors	134
Countertops.....	134
Accessories.....	135
Detectors.....	135
Condensation	135

TABLE OF CONTENTS

Routine Maintenance Schedules	136
Winterizing.....	137
De-Winterizing	139
17 Maintenance & Data Charts	140
RV Owner Data Sheet.....	141
RV Owner Maintenance Record	142



GENERAL INFORMATION

Chapter

1

GENERAL INFORMATION



WELCOME TO A LIFE OF “ROUGHING IT SMOOTHLY”



Tiffin Motorhomes – Made To Move You

Tiffin Motorhomes is excited that you have entered the world of motorhome travel and we believe that you and your family will enjoy this way of life for years to come.



Your Tiffin-built motorhome provides the comforts of home while allowing you to travel freely as you choose.

However, before heading out on the open roads, make yourself familiar with this owner's manual to learn more about the operations of your motorhome. Also, work with your dealer to learn as much as possible about the functionality and features of your coach.

And remember, *“wherever you go, we go.”*

ABOUT THIS MANUAL

Carefully read this manual to understand how everything in your motorhome works.

NOTE: This operator's manual describes the features of your motorhome and includes instructions for their safe use. The manual, however, including its photography and illustrations, is of a general nature. Some equipment and features described in this manual might be optional or unavailable on your model.

The instructions included are to serve as a guide and in no way extend the responsibilities of Tiffin Motorhomes beyond the standard written warranty. The descriptions, illustrations, and specifications in this manual were correct at the time of printing and Tiffin Motorhomes reserves the right to change specifications or design without notice, and without incurring the obligation to install the same on products previously manufactured.

GENERAL INFORMATION



TIFFIN

MOTORHOMES

Many of the instruction sheets and manuals for the various appliances in your motorhome are in this manual for your convenience.

DELIVERY

Throughout the entire manufacturing process, your Tiffin motorhome has been regularly inspected by our qualified personnel to ensure that you receive the finest product of the highest quality. However, the final inspection at our factory is not the last one. The pre-delivery inspection and system check that your dealer perform are the final inspections before you receive your new motorhome. Your dealer is also available to assist you in understanding the warranties and completing the necessary forms to activate the warranties for the various appliances and accessories installed in your motorhome.

DEALER RESPONSIBILITIES

A **pre-delivery inspection and systems check** is to ensure a thorough inspection of the motorhome and the proper operation of all factory-installed components.

A **customer walk-through** helps to familiarize you with the motorhome, its systems and components, and their proper and safe operation.

Delivery of the **Owner's Information Package**, which contains warranty cards and registrations for the vehicle and all factory-installed components from other vendors and suppliers to Tiffin Motorhomes. The detailed operation and maintenance instructions on these components are also included in this package.

Assisting the customer in **completing the registration forms** to avoid loss of warranty coverage. The dealer will review the limited-warranty provisions with the customer and stress the importance of completing the warranty cards and registration forms for the components in the motorhome to enable the manufacturers to receive them within the prescribed time limits.

Providing the customer with **information regarding warranty and non-warranty work** on the vehicle and its separately warranted components.

CUSTOMER RESPONSIBILITIES

The customer is responsible for regular and proper maintenance of the motorhome. Properly maintaining your motorhome will prevent conditions arising from neglect that are not covered by your Tiffin Motorhomes limited warranty. The maintenance guidelines in this manual and any other

GENERAL INFORMATION

applicable manuals must be followed. It is your responsibility and obligation to return the vehicle to an authorized dealer for repairs and service.

To assist you in avoiding problems with your motorhome, Tiffin Motorhomes recommends that you do the following:

Read the warranty. Go over it thoroughly with your dealer to make sure you understand all the terms and conditions of the warranty.

Inspect the motorhome; do not accept delivery until you have gone through the motorhome with the authorized Tiffin Motorhomes dealer.

Ask questions about anything you do not fully understand about your motorhome. Tiffin Motorhomes is here to serve you and ensure that you have all the information necessary for the safe and enjoyable use of your new motorhome.

When you are taking delivery, **set an appointment for adjustments.** This appointment must be within two weeks after you accept delivery.

You are responsible to **use your motorhome in a responsible, safe manner.** Take the time to familiarize yourself with the proper operation of the unit before you attempt to use it.

REPORTING SAFETY DEFECTS (USA)

575.6(a)(2)(i) At the time a motor vehicle manufactured on or after September 1, 1990 is delivered to the first purchaser for purposes other than resale, the manufacturer shall provide to the purchaser, in writing in the English language and not less than 10 point type, the following statement in the owner's manual, or, if there is no owner's manual, on a one-page document:

If you believe that your vehicle has a defect which could cause a crash or could cause injury or death, you should immediately inform the National Highway Traffic Safety Administration (NHTSA) in addition to notifying TIFFIN MOTORHOMES.

If NHTSA receives similar complaints, it may open an investigation, and if it finds that a safety defect exists in a group of vehicles, it may order a recall and remedy campaign. However, NHTSA cannot become involved in individual problems between you, your dealer, or Tiffin Motorhomes.

To contact NHTSA, you may either call the Vehicle Safety Hotline toll-free at 1-888-327-4236 (TTY: 1-800-424-9153); go to <http://www.safercar.gov>; or write to: Administrator, NHTSA, 1200 New Jersey Avenue, S.E., Washington, DC 20590. You can also obtain other information about motor vehicle safety from <http://www.safercar.gov>.

(ii) The manufacturer shall specify in the table of contents of the owner's manual the location of the statement in 575.6(a)(2)(i). The heading in the table of contents shall state "Reporting Safety Defects."

REPORTING SAFETY DEFECTS (CANADA)

Vehicles domiciled in Canada that are thought to have a defect that could cause a crash, injury, or death, should immediately be reported to Transport Canada and Tiffin Motorhomes at 1-256-356-8661.

GENERAL INFORMATION

If Transport Canada receives similar complaints, it may open an investigation; if it finds that a safety defect exists in a group of vehicles, it may order a recall and remedy campaign. However, Transport Canada cannot become involved in individual problems between you, your dealer, or Tiffin Motorhomes.

To contact Transport Canada, call the Defect Investigation and Recall Division toll-free in Canada at 1-800-333-0510 or 1-819-994-3328 in the Gatineau-Ottawa area or internationally.

By Mail:

Transport Canada – ASFAD

330 Sparks Street

Ottawa, ON

K1A0N5

SIGNALEMENT DES DEFAUTS DE SECURITE A TRANSPORT CANADA POUR LES PROPRIETAIRES CANADIENS

Si vous pensez que votre véhicule présente un défaut lié à la sécurité, vous devez immédiatement en informer Transports Canada (TC) ainsi que Tiffin Motorhomes, Inc.

Si Transports Canada reçoit des plaintes similaires, il pourrait ouvrir une enquête à ce sujet. Si le Ministère constate l'existence d'un défaut de sécurité au sein d'un groupe de véhicules, il pourrait ordonner une campagne de rappel et de réparation.

Toutefois, Transports Canada ne peut pas intervenir en cas des problèmes individuels entre vous, votre concessionnaire ou Tiffin Motorhomes, Inc.

Vous pouvez communiquer avec Transports Canada par l'un des moyens suivants:

Par téléphone: 819-994-3328 (région de Gatineau-Ottawa ou international)

Numéros sans frais: 1-800-333-0510 (au Canada)

Par la poste:

Transports Canada – ASFAD

330, rue Sparks

Ottawa (Ontario)

K1A 0N5

Vous pouvez également consulter le site Web de Transports Canada à tc.canada.ca pour remplir en ligne un formulaire de plainte de défauts.

TIFFIN MOTORHOMES LIMITED WARRANTY

The Tiffin Motorhomes limited warranty is provided to you by your authorized Tiffin Motorhomes dealer during the pre-delivery inspection. When you enquire about your Tiffin Motorhomes warranty, refer to this document. If you require an additional copy of the warranty or other information, contact:

Tiffin Motorhomes, Inc.

105 2nd St. NW • Red Bay, AL 35582

Phone: 256-356-8661

Email: info@tiffinmotorhomes.com

Visit www.tiffinmotorhomes.com for access to related materials.

GENERAL INFORMATION

MAJOR EQUIPMENT MANUFACTURERS

The following list is a compilation of the vendors and suppliers of the major subsystems and components of your motorhome. This list is provided for your convenience and is not a substitution of the literature accompanying the “how to contact us” information supplied by the vendors and suppliers in your Owner’s Information Package. Where appropriate, website information is also provided.

• Atwood Mobile Products	(800) 825 4328	atwoodmobile.com
• Aqua-Hot	(800) 685-4298	aquahot.com
• Denso Corporation	(800) 366 1123	globaldenso.com
• Flexsteel Industries	(563) 556 7734	service@flexsteel.com
• HWH Corporation	(800) 494-3213	hwhcorp.com
• Kwikkee	(541) 942-3888	kwikkee.com
• Norcold, Inc.	(800) 543-1219	norcold.com
• Onan Corporation	(256) 883-8164	onanindiana.com
• Power Gear	(800) 334-4712	powergear.com
• RV Products (Coleman A/C)	(316) 832-3400	airxcel.com
• Precision Circuits Inc.	(630) 240-9832	precisioncircuitsinc.com
• Saf-T-Alert (CO/LP Alarm)	(800) 383-0269	safetalert.com
• Sharp Corporation	(800) 237-4277	sharp-usa.com
• Suburban Manufacturing Co.	(423) 775-2131	suburbanmanufacturing.com
• The Dometic Corporation	(219) 294-2017	dometic.com
• Whirlpool	(800) 749 7929	whirlpool.com
• Winegard	(800) 288 8094	help@winegard.com
• LG	(800) 243-0000	lg.com
• Valid Manufacturing Ltd.	(888) 632-6477	validmanufacturing.com

WARRANTY SERVICE

All warranty service needs to be completed during the warranty period (basic warranty: 12 months or 12,000 miles). Tiffin Motorhomes warrants its unitized construction for 10 years and its laminations for five years. Any service work performed after the expiration of the Tiffin Motorhomes warranties **WILL NOT** be covered by those warranties.

Exceptions may be made, on an individual basis, to this deadline, because of the unavailability of parts and/or service appointment time where work is to be performed. However, do not rely on the possibility of an exception; schedule any desired in-warranty work before your warranty expires.

OWNER’S INFORMATION PACKAGE

The Owner’s Information Package includes valuable documents about your motorhome and its components and systems. By consulting the booklets and instruction manuals included in the Owner’s

GENERAL INFORMATION

Information Package, you will learn how to operate, maintain, and troubleshoot these items safely and effectively. The Tiffin Motorhomes Owner’s Manual does not cover every possible detail of equipment—standard and/or optional—installed on or in your vehicle.

As with all valuable documentation, keep them in a safe, secure place for your later use and consultation. When you complete and mail to the respective manufacturers any warranty/guaranty registration cards, make a photocopy of both sides of each card before mailing, and keep the photo copy in your permanent records for your motorhome.

CUSTOMER RELATIONS

To schedule maintenance or service, or order parts, notify your local authorized Tiffin Motorhomes dealership to set up an appointment. If you are unsure of the location of your nearest authorized Tiffin Motorhomes dealership, access the Tiffin Motorhomes website at www.tiffinmotorhomes.com, and then click on the “Locate Dealer” button, and then enter the appropriate search criteria, such as state and retail sales, and then click on the red ball located on the map to find dealer information in that area.

SPECIFICATION LABELS

There are two main numbers used to identify your motorhome. The Vehicle Identification Number (VIN) is the legal identification of the vehicle. The VIN is the number used by the state for vehicle identification and registration. Additionally, there is a Tiffin serial number (Figure 0-1). This number can be found on the side of the dashboard. A typical sample of this identification label is shown below.



Figure 0-1: Tiffin Serial Number



Figure 0-2: RVIA Label located on the outside of the motorhome

GENERAL INFORMATION



Figure 0-3: Federal Motor Vehicle Standards label located inside the doorway of the coach

Another label affixed to your motorhome is the Recreational Vehicle Industrial Association (RVIA) Weight Label (Figure 0-2), which is a required label for your vehicle. Tiffin Motorhomes, a manufacturer-member of RVIA, has the obligation to disclose the following information to the purchaser of the motorhome:

- An indication of the contents of the motorhome weight label affixed to the motorhome.
- A concise explanation of the following items' vehicle Weight (VW) distribution and proper weighing techniques to be used to weigh the vehicle.

Specific definitions for the following terminology:

Gross Vehicle-Weight Rating (GVWR) – This is the maximum permissible weight of the motorhome when it is fully loaded.

Unloaded Vehicle Weight (UVW) – This is the weight of the motorhome, as built at the factory, with full fuel, engine oil, and coolants. The UVW does not include cargo, fresh water, LP gas, or any dealer-installed accessories.

Occupant Cargo-Carrying Capacity (OCCC) – This is the GVWR of the motorhome minus UVW and weight of LP gas.

Gross Combination-Weight Rating (GCWR) – This is the value specified by the chassis manufacturer as the maximum allowable loaded weight of the motorhome with a towed trailer and/or vehicle (if any).

Sleeping-Capacity Weight Rating (SCWR) – This is the maximum weight capacity of the combined number of persons (i.e., number of people multiplied by 154 pounds per person) permitted to sleep within the vehicle.

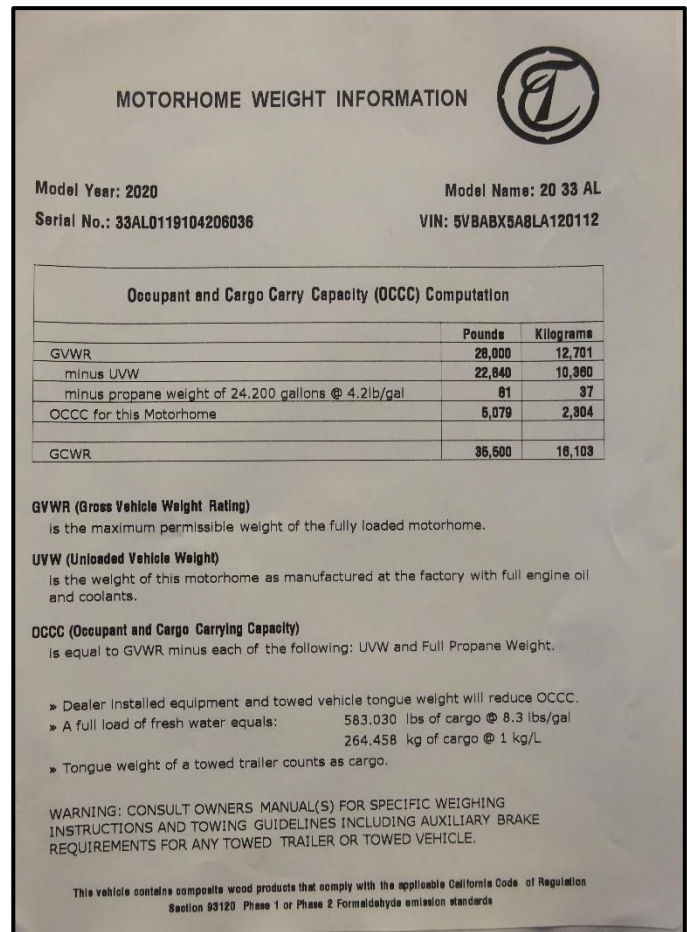

Figure 0-4: Sample Motorhome Weight Label (found in the bedroom closet)

GENERAL INFORMATION

Gross Axle-Weight Rating (GAWR) – This is the maximum allowable weight for an axle; the GAWR considers the weakest link in the tire, wheel, brakes, hubs, axle, springs, and attaching parts. To illustrate, if the axle is rated at 15,000 pounds and the tires are rated at 3,200 pounds each as a dual installation, then the maximum GAWR will be 12,800 pounds for a four-tire vehicle.

WEIGHING PROCEDURES

To weigh the motorhome properly, the motorhome must be level when the weighing process is performed. Your motorhome has been designed and built in compliance with the recommended limits of the major-component/system suppliers to provide a realistic OCCC. It is up to the final user to provide even distribution to prevent uneven loading. Once the vehicle is loaded, it can be taken to any certified drive-on scales or individual-wheel scales to determine that the final weight is within specified limits for the motorhome.

To Determine the Final Weight of the Motorhome:

Drive the motorhome onto the scales so that all wheels are on the scales; this provides the gross vehicle weight (GVW) of the vehicle and can be recorded as such. The GVW must not exceed the GVWR specified for the vehicle.

Drive the motorhome so that only the rear wheels remain on the scales; this provides the total weight of the vehicle, save for the front axle. This weight must not exceed the total rating of the axles remaining on the scales. The front axle weight is determined by subtracting the weight from the GVW that was obtained in the first step. The result must not exceed the listed front-axle weight rating.

WEIGHT DISTRIBUTION

To ensure the maximum stability of the motorhome under static (i.e., parked) and dynamic (i.e., moving) conditions, the distribution of the items to be carried and stored within the motorhome and in the storage bays underneath the motorhome must be performed in such a manner as to strive for reasonably even side-to-side and front-to-rear dispersion of the weight of the stored items. This process will ensure that the motorhome is not “lop-sided” in weight distribution (i.e., all the stored weight is not on one side and/or mainly toward the front or the rear). Keeping a center of mass of the motorhome essentially centered on a front-to-rear and side-to-side basis will provide better control of the motorhome when it is in motion.

GENERAL INFORMATION

SAFETY MESSAGES

Note that several labels listed in this manual represent items that need your attention. The Danger, Warning, Caution, and Notice labels alert you to precautions that might help you to avoid damage to your motorhome, its equipment, or your personal safety. Read and follow them carefully.



CAUTION

CAUTION indicates a hazardous situation, which, if not avoided, could result in minor or moderate personal injury, or damage to the equipment.

NOTICE

NOTICE is used to address practices not related to personal injury, or damage to the equipment.



WARNING

WARNING indicates a hazardous situation, which, if not avoided, could result in death or serious personal injury, or damage to the equipment.



DANGER

DANGER indicates a hazardous situation, which, if not avoided, will result in death or serious personal injury, and damage to the equipment.



SAFETY INSTRUCTIONS

Chapter

2

SAFETY

SAFETY CONSIDERATIONS

Before using your motorhome, especially for the first time or after a long period of non-use, read all the instructions in the Owner's Manual and the chassis-manufacturer's manual thoroughly. There are several safety considerations that you must be aware of and follow while your motorhome is in motion. These safety considerations, as well as others meant to preclude any damage to the motorhome, are listed in this chapter. Besides the driver, it would be helpful for the passengers to be familiar with these safety considerations and precautions too.



WARNING

Before your motorhome is to be towed, be sure that you have read the entire Owner's Manual and that you fully understand the equipment on your motorhome and how to use that equipment safely.

GENERAL WARNINGS

In general, several "common-sense" safety precautions must be taken every time the motorhome is to be used on the road. These precautions include:

- Only seats with seat belts must be used while the motorhome is in motion; the seat belts should be worn by all people (driver and passengers) in the motorhome at that time.
- While the motorhome is moving, lock all seats in the forward-facing position to provide maximum safety for the users.
- While the motorhome is moving, no one (e.g., young children) inside should ever stand or kneel on the seats.
- In the majority of states, it is the law that seat belts must be used (fastened snugly about the chest and hip areas), anytime the motorhome is in motion, to provide desired protection in the event of a crash.
- Any fire extinguishers must be inspected on a monthly basis to ensure that each extinguisher is properly charged and ready for operation.
- Any smoke and/or carbon monoxide (CO)/liquid propane (LP) alarms must be regularly inspected and tested. If being used for the first time, the smoke and/or CO/LP alarm must be properly activated and fresh batteries installed before the motorhome is placed into service. Never sleep in a motorhome not having functional smoke and/or CO/LP alarms.
- While the motorhome is moving, the sleeping facilities are not to be used.
- Be sure to be familiar with all emergency exits (doors, emergency window). Do not use the emergency window as a routine exit; this is strictly to be used for emergency purposes only.

SAFETY

- Movement inside the motorhome should be minimized while the motorhome is in motion.
- Never leave the driver's seat unattended while the motorhome is in motion.

PRE-DEPARTURE CHECKLIST

For your continued safety and convenience, the following is a representative "checklist" designed to ensure your safety while driving:

- ✓ Clean all windows, mirrors, and light lenses (front, back, and sides) to ensure that you can "see" and "be seen."
- ✓ Reposition any mirrors or other fixtures to provide an unobstructed view (front, back, and sides) from the driver's seat.
- ✓ Remove or secure all loose fixtures (e.g., awnings, flags, antennas, portable lights) to keep them from falling from the motorhome when the vehicle is in motion.
- ✓ Make a "walk-around" visual inspection of the motorhome to note any irregularities (e.g., loose trim) or problems (e.g., low tires); correct noted problems accordingly.
- ✓ Check all exterior storage-compartment and generator-compartment doors to make sure that they are properly latched. If need be, check inside all exterior compartments to make sure that all cargo and equipment are properly secured so that they do not work loose and become hazards during sudden starts and stops.
- ✓ Check the tires for proper inflation (i.e., cold-inflation pressure: 100 psig). If the motorhome has not been used recently, make sure that the "cold-inflation" pressure is maintained. If the motorhome has recently been used, make sure that the "hot inflation" pressure (see the tire-manufacturer's literature to determine appropriate "hot inflation" pressure) is maintained. All tire pressures must be within 1-2 pounds (psi) of each other.
- ✓ Examine wheel lug nuts to ensure their proper tightness. If any lug nuts are found to be loose, first check the fit of the wheel to the hub to make sure the wheel is mounted properly, which would produce a "wobbly" wheel when the motorhome is in motion, and then tighten the lug nuts.
- ✓ Check all fluid levels (e.g., engine oil, transmission fluid, coolant, power-steering fluid, brake fluid, battery fluid [if applicable], windshield-washer solvent) to ensure that correct levels are maintained. Fill any low reservoirs, as needed.
- ✓ DO NOT SUBSTITUTE any other fluids for specified oils, transmission fluid, brake fluid, or other hydraulic fluids—substitutions are not acceptable and can void warranties.
- ✓ Before starting the motorhome engine, make sure all lines (e.g., water, sewer) and electrical power cords are disconnected and properly stowed.



SAFETY

- ✓ Ensure that the levelling jacks are in the “travel” position and antennas are securely docked.
- ✓ After entering the motorhome, make sure that the electrically actuated, retractable step has properly operated to retract the step fully before starting the engine of the motorhome.
- ✓ Check all interior doors (e.g., shower, microwave, refrigerator, etc.) to ensure that they are locked and/or secure. Make sure that all large items are stored away and secure (e.g., coffee pots, corning ware, etc.).

DRIVING SAFETY

Various adjustments must be made to ensure the driver’s comfort and the safety of the motorhome before starting and moving the motorhome; these include:

- Do not attempt to adjust the driver’s seat while the vehicle is moving.
- Do not adjust the tilt steering while the vehicle is moving.
- The driver must be familiar with all gauges, instruments, switches, and indicators on the instrument panel before driving.
- Do not operate the cruise-control function during any extreme weather situations (e.g., snow, ice, sleet, heavy rain), or when road conditions are hazardous (icy, snowy, winding roads, city traffic), when a constant speed of the motorhome is not possible, or if traffic conditions do not warrant such.
- Avoid driving the motorhome through any standing water. If deep enough, such water can wet the brake pads and cause fading of the brakes (i.e., loss of braking power) and lead to excessive sliding or pulling to one side or the other.
- Know the limits of operation of the motorhome. Do not try to achieve excessive speeds, climb overly steep hills, traverse overly long grades, attempt to use as an "off-the-road" (OTR), rapidly switch lanes, or rapidly accelerate or decelerate the motorhome. When in doubt about the handling characteristics of the motorhome, consult your chassis manual for information.
- The solar or blackout shade is operated by using a switch on the driver’s console. Depress the switch to lower or raise the shade. On the BYWAY, the switch is labeled SOLAR SHADE or NIGHT SHADE. The time delay switch must be held for a few seconds before it is activated.



Figure 0-1: Driver’s side Dashboard and Instrument Console



SAFETY

- **NEVER** drive the vehicle with a slide-out room extended.

FUELS FOR THE MOTORHOME



WARNING

Liquid propane (LP) gas containers, gasoline, or other flammable liquids must not be placed or stored inside the motorhome because a fire or explosion might occur. LP gas containers (Figure O-2) are equipped with safety valves that might relieve excess pressure by discharging gas into the atmosphere—any containment of that vented LP gas constitutes an explosive hazard.



Figure O-2: LP Tank and Regulator

Your motorhome is designed to use low sulfur fuel only for the engine used in the routine operation of the motorhome—these require prudent and safe handling to ensure safety of the motorhome and its occupants; namely:

- Anytime the motor fuel is to be filled, turn OFF the motorhome engine, all pilot lights, and appliances.
- **DO NOT SMOKE** when refilling the fuel tank.
- **NEVER** use an open flame to test for LP gas leaks or to examine the fluid levels in the fuel tanks.
- After filling any LP system, immediately replace and secure all protective covers and caps.
- After closing the LP valve, close and securely latch the LP door to prevent unintentional access or damage.
- **NEVER** connect natural gas to the LP gas system—LP gas and natural gas are not interchangeable.
- When lighting range burners, do not turn burner controls ON and allow the gas to escape before lighting.
- **NEVER** use any other “burning” equipment (e.g., charcoal grills, wood stoves, butane lights, propane lights) inside the motorhome. Doing so might cause fires and/or asphyxiation.



DANGER

All pilot lights, appliances, and their ignitors must be turned OFF before refuelling of motor fuel tanks or propane containers. A failure to comply could result in serious injury or death.

SAFETY

	WARNING
<p>Any portable, fuel-burning equipment (e.g., charcoal, propane, butane, wood) must not be used inside the motorhome. Any use of such equipment inside the motorhome might readily cause fires and/or asphyxiation by carbon-monoxide poisoning. Moreover, such unauthorized use will probably invalidate your motorhome insurance policy.</p>	

LIQUID PROPANE (LP) GAS SYSTEM

Check the propane gas system for leaks yearly or as necessary. If you smell propane within the motorhome, quickly perform the following:

- Extinguish any open flames, pilot lights, and all smoking materials.
- Do not touch electrical switches.
- Shut off the gas supply at the tank valve or gas supply connection.
- Open doors, windows, and other ventilating openings.
- Leave the area until the odor clears.
- Have the propane system checked and leakage source corrected immediately.

	WARNING
<p>A failure to comply with the above guidance could result in serious injury or death.</p>	

A WARNING label such as the following is located near the LP gas container.

SAFETY

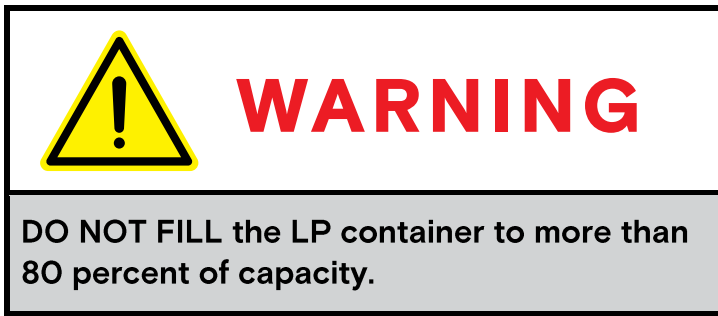

Any overfilling of the LP gas containers can result in uncontrolled gas flow—a prime condition for a fire or explosion.

The LP container (Figure 0-3) must be filled to only 80 percent of its capacity; the remainder of the cylinder space is an air space to contain expansion of the liquid when subjected to varying ambient-temperature conditions. Filling in excess of 80 percent of the liquid volume of the container reduces the air space and, thus, creates a condition for possible over-pressurization of the container.

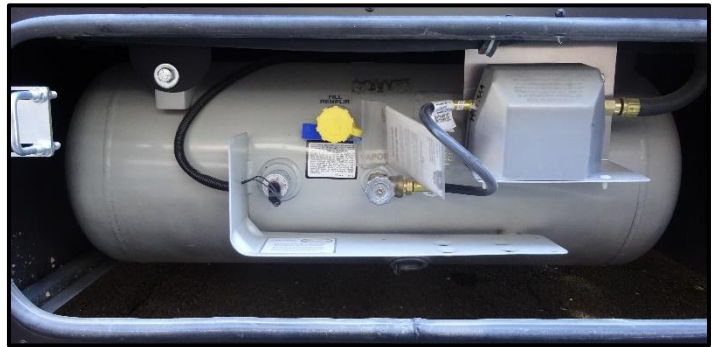

Figure 0-3: LP Tank and Regulator

All LP appliances in your motorhome have been approved for use in motorhomes by a nationally recognized testing laboratory (i.e., UL and CSA certified). When properly used, LP gas is a clean-burning fuel, which can be dependably used. In actuality, the LP container contains liquid propane under high pressure.

The liquid, when it passes through the tank valve to a lower pressure, vaporizes into a gas, and then passes through a regulator to maintain a constant pressure. This gas, then, is the actual fuel distributed through the LP-gas manifold system to the LP-based appliances used in your motorhome.

LP-appliance lighting problems are typically caused by an improperly adjusted gas regulator. NEVER attempt to adjust or reset the gas regulator yourself. An authorized service technician is needed to make these adjustments. As a good preventive-maintenance activity, the regulator should be checked annually by a service technician and before every extended trip.

Even though the LP-gas system is leak-checked and verified at the factory at the time of manufacture, normal usage (travel vibrations, etc.) could loosen the fittings. Consequently, it is wise to check the gas fittings periodically for leak tightness.

You can wipe some leak-detector solution (e.g., a “liquid-soap”-like solution) on all the fittings, connections, and junctures when the system is under pressure. Should there be any leaks; small bubbles will appear at any leak sites. Generally, loose fittings can be tightened to stop the leaks. If this process does not work, then you must shut off the main gas valve at the LP cylinders and immediately consult an authorized service technician to determine what repairs are necessary. Leaks may also be detected by noting a sulphurous odor (i.e., rotten eggs). DO NOT search for a leak by using a match or open flame.

SAFETY

LP GAS REGULATOR

The LP gas regulator is the most critical element of the LP-gas distribution system. The regulator converts the high-pressure LP gas from the tank into a reduced-pressure LP-gas supply suitable for use in the various appliances in the motorhome.

You must regularly inspect the regulator system. If any damage or corrosion is noted, contact an authorized service technician to inspect and repair or replace the regulator.

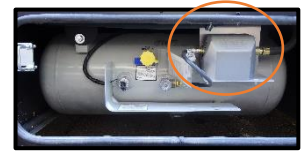



Figure 0-4: LP

Do not attempt to adjust the regulator yourself; the regulator has been pre-set at the factory. Only a qualified LP service technician using specialized equipment should adjust the regulator.



WARNING

When the motorhome is not in use, be sure to close the main LP gas valve at the tank. When the LP gas tank is to be refilled, close the main valve to preclude the chance of pilot lights possibly igniting fumes from the LP fuel. As some LP-gas appliances (e.g., refrigerator, furnace, water heater) have Direct Spark Ignition (DSI) systems, it is very important that these appliances be turned off when the LP gas is off. The DSI boards will continue to work (i.e., emit an ignition spark) even when there is no LP gas available.

LP DISTRIBUTION SYSTEM

The primary LP distribution system in the motorhome is a steel manifold located underneath the motorhome. The secondary distribution lines running from this main distribution system are usually reinforced rubber supply lines.

If any of the gas lines break, do not attempt to splice them—always run new lines to maintain the safety of the motorhome. Tiffin Motorhomes recommends that only qualified service technicians perform this work.

Remember, the main valve at the LP gas tank must be closed whenever any gas appliance is to be installed, removed, or serviced—this process prevents LP gas leakage, which could result in a possible harmful explosion. If the odor of LP gas is ever detected, immediately discontinue use of any gas appliances and seek the services of a qualified service technician.

SAFETY

	WARNING
The LP gas distribution system in your motorhome is designed for liquefied petroleum (LP) gas ONLY. DO NOT attempt to connect and use any natural gas or butane gas system with this LP gas system.	

RECOMMENDED PRACTICES

The following practices are recommended to ensure continued safety and reliability of the LP gas system. These are representative, and not exhaustive. In all cases, use common sense in the use of the LP system:

- Visually inspect the LP fill valve before any refueling operation for foreign materials or debris; remove, as necessary, to ensure a leak-tight connection.
- Before any refueling operation of the LP gas system, shut off all the pilot lights.
- NEVER, under any circumstances, check for LP gas leaks with any type of open flame; doing so would probably cause an explosion and subsequent fire.
- Annually and before any major trips, visually inspect the entire LP gas distribution system.

Should problems be noted, seek the services of a qualified service technician to make necessary repairs and perform any maintenance.

CARBON MONOXIDE WARNING

	WARNING
Avoid inhaling exhaust gases as they contain carbon monoxide, which is a colorless, odorless, and poisonous gas. Serious illness, injury, or death can result.	

A properly maintained engine exhaust and ventilation system is the best way to protect against carbon monoxide's entry into the vehicle. Tiffin Motorhomes recommends that the exhaust system and body be inspected by a qualified motorhome service center:

SAFETY

- Each time the vehicle is serviced for an oil change.
- Whenever a change in the sound of the exhaust system is noticed.
- Whenever the exhaust system, underbody, or rear of the vehicle is damaged.

To allow proper operation of the vehicle's ventilation system, keep the front ventilation inlet grill clear of obstructions at all times.

Do not occupy a parked vehicle with the engine running for an extended time, and do not run the engine in confined areas, such as a garage.

Your motorhome is equipped with a combination CO/Gas Alarm (Figure 0-5). This alarm combines a single compact system that detects both Carbon Monoxide (CO) and Propane (LPG) gas. It will detect carbon monoxide gas from any combustion source such as the furnace, oven/range, water heater, refrigerator, chassis engine, and generator engine.

CO/LP GAS DETECTOR

Since LP gas is denser than air, the LP gas will naturally settle to the lowest point in an enclosed space. In the motorhome, this would be the floor. Because of this, the CO/LP gas detector (Figure 0-5) is necessarily mounted close to the floor.

To activate the CO/LP-gas sensor on this detector for the first time, remove the sensor activation strip, if it was not removed during the pre-delivery inspection.

If the alarm persists in re-arming and giving further alarms, ventilate the motorhome by opening the doors and windows. After the ventilation process is concluded, shut all the doors and windows, and then take the motorhome to a qualified service technician.

The CO/LP gas detector is a single compact system that provides a powerful combined alarm that detects both Carbon Monoxide (CO) and explosive gases, such as Propane (LPG) and Methane (Natural Gas). This detector uses the latest microprocessor technology combined with two electronic self-cleaning sensors that operate independently of each other. The combined unit can detect both CO and explosive gases simultaneously.

Carbon monoxide (CO) is a colorless, odorless, tasteless gas, which, when breathed, bonds to the hemoglobin in the red blood cells and, thus, drastically reduces or blocks the transfer of oxygen from the lungs to the rest of the body.

In sufficient concentrations, CO kills by asphyxiation. In lesser amounts, CO makes the victim groggy, lethargic, and unable to think clearly or quickly.

CO is one of the products of combustion for many materials including petroleum-based products (e.g., gasoline, diesel fuel, propane, butane, etc.). Since many of the appliances and the engines associated with the motorhome produce CO in their normal operations, it is necessary to ensure that CO levels do not



Figure 0-5: Carbon Monoxide/LP Gas Detector

SAFETY

rise to dangerous levels within the motorhome. In sufficiently high concentrations, CO can kill in minutes.

The most susceptible people to CO poisoning are unborn babies, small children, pregnant women, senior citizens, and people with cardiovascular or respiratory problems.

Consequently, it is prudent to check the CO monitor regularly for normal operation and to remain aware of the symptoms of CO poisoning, which include dizziness, nausea, vomiting, muscular twitching, throbbing in the temples, incoherent thinking and speech, weakness, sleepiness, and intense headaches.

If any of these symptoms are experienced in the motorhome, IMMEDIATELY evacuate the motorhome and seek medical help. Shut down the motorhome and do not attempt to operate it again until the sources of the CO are located and fixed.



DANGER

Carbon monoxide gas—derived from products of combustion of diesel fuel, LP gas, and other petroleum-based products—is a deadly gas that can kill motorhome occupants, if allowed to accumulate in sufficient concentration. Ensure that all engine operations are not restricted—tailpipes and exhaust ports should not be blocked or restricted in any way. Additionally, any accumulation of exhaust gases outside or underneath the vehicle must be avoided as it might enter the motorhome through windows or vents—be careful of how and where the motorhome is parked to avoid such conditions. Regularly monitor outside conditions to ensure that all exhaust gases can readily be dissipated and not enter the motorhome inadvertently.



DANGER

Never sleep in a motorhome when the engine is running—engine exhaust fumes could enter the motorhome and cause disability or death. Regularly check the exhaust system to note any leakage sites and, if found, discontinue use of the motorhome until they are repaired by a competent, qualified service technician. Do not attempt repairs on the exhaust system yourself and do not modify (temporarily or permanently) the exhaust system at all.

SAFETY

FIRE SAFETY

As with any enclosed system containing the three required conditions for fire (i.e., combustible materials, oxygen, and ignition sources), there will exist the possibility of fire inside the motorhome. Tiffin Motorhomes has taken every precaution and design practice to minimize or negate this possibility, but the final determination rests with the owner and user of the motorhome. Hence, the owners, users, and their guests must be aware of basic fire-safety practices and procedures, and those particular features that Tiffin Motorhomes has provided for fire safety.

FIRE EXTINGUISHER

The motorhome is equipped with a fire extinguisher located in the entrance door stairwell (Figure 0-6). The extinguisher is rated for both Class B (i.e., grease, gasoline, diesel fuel, flammable liquids) and Class C (i.e., electrical) services.

Read and understand the accompanying owner's manual on the extinguisher (found in your Owner's Information Package) and remember the location of the extinguisher. These types of fire extinguishers are pressurized mechanical devices and require that appropriate care be used in their safe storage and use. The owner's manual will provide necessary guidance for the proper storage, handling, and use of the extinguishers.

Prudent preventive maintenance suggests monthly inspection of any fire extinguisher to ensure that it is sufficiently pressurized (i.e., the needle on the gauge is in the "normal" zone) and that the mechanical components are not blocked in any way.

DO NOT test a fire extinguisher by partially discharging the unit—this will cause a loss of pressure and might lodge some fire-retardant materials in the valve mechanism and cause the extinguisher to continue to vent slowly down to zero pressure. If an extinguisher is ever partially used, continue its use until the unit is completely discharged. Then, have the fire extinguisher fully recharged at an appropriate service center (call any fire department for information on having an extinguisher recharged in that particular locality).

DO NOT wait to recharge an empty fire extinguisher; you will never know when it might be needed.

Should a fire occur inside or around the motorhome, evacuate the motorhome quickly and calmly—do not panic. In the event of heavy smoke or extensive flames, keep low (crawl if you must), and make your way to the nearest exit (door, emergency window) and leave. If the fire involves a fuel source (e.g., diesel fuel, LP gas), consider the probability of an explosion and move sufficiently far away to minimize personal harm. If possible, immediately place a call to the local fire department (or ask someone nearby to do so) to report the fire. Consider the cause and the consequences of the fire and the risks associated with possibly fighting the fire yourself before trying to extinguish it.

DO NOT expose yourself or others to unnecessary danger.



Figure 0-6:
Fire Extinguisher

SAFETY

SMOKE DETECTOR

The motorhome is equipped with a battery-operated smoke detector (Figure 0-7) located on the ceiling in the living area of the motorhome.

The smoke detector must be tested on a weekly basis, before each trip, and after any period of storage of the motorhome.

If a low-battery condition is noted or the alarm “chirps” to indicate a low-battery condition, immediately replace the battery. Tiffin Motorhomes recommends that you keep replacement batteries in the motorhome for any in-transit replacements so that the smoke-alarm capability is never compromised.

DO NOT disable the smoke detector for any transient, false alarm (e.g., cooking smoke, dusty furnace, tobacco smoke). Ventilate the motorhome with fresh air and the alarm will reset on its own.



Figure 0-7: Smoke Detector

ELECTRICAL

- Careless handling of electrical components can be fatal. Never touch or use electrical components or appliances while feet are bare, while hands are wet, or while standing in water.
- Improper grounding of the vehicle can cause personal injury.
- Do not attach an extension cord to the utility power cord.
- Do not use any electrical device that has had the ground pin removed.
- Avoid overloading electrical circuits. Replace fuses or circuit breakers with those of the same size and amperage rating only. NEVER use a higher rated fuse or breaker.

LOADING

- Store or secure all loose items inside the motorhome before traveling. Possible overlooked items such as canned goods or small appliances on the countertop, cooking pans on the range, or freestanding furniture can become dangerous projectiles during a sudden stop.
- Be aware of GVWR, GAWR, and individual load limit on each tire or set of duals.
- Never load the motorhome in excess of the gross vehicle weight rating or the gross axle weight rating for either axle.

MAINTENANCE

- Do not remove the radiator cap while the engine and radiator are still hot. Always check the coolant level visually using the see-through coolant reservoir.
- NEVER get beneath a vehicle that is held up by a jack only.
- Do not mix different construction types of tires on the vehicle. Replace tires with the exact size, type, and load range.

SAFETY

EMERGENCY EXITS

The living areas of the motorhome are equipped with emergency exit windows (Figure 0-8 and Figure 0-9). These windows are designed for emergency exits when it is not practical to exit by the door, which also is an emergency exit—in the front of the motorhome. These windows are readily noticeable by their red handles and the red EXIT label on the windows.



Figure 0-8: Emergency Window



Figure 0-9: Emergency Exit Latch

To use these windows as emergency exits, lift the handle and push outward on the window. As required, the window can be closed by pulling the window inward and then lowering the handle to latch the window back in place. When the motorhome is to be parked, note where these windows will be, so that the exits will not be blocked (e.g., against a tree, pole, or wall).

PARKING PROCEDURES

To park the motorhome in any unfamiliar terrain, examine the site for surface irregularities, slopes, or inclines, and other items such as stumps, rocks, or external connections for power/water/sewage, and examine the area immediately above the parking site for obstructions like tree branches and limbs, signs, and overhead wiring.

If the motorhome is to be backed into the parking site, try to have that site on the driver's left-hand side, as this will allow the driver to watch the rear of the motorhome. Back up slowly and use the side mirrors and the back-up camera as a guide or, better yet, have another person outside provide guidance to help park the motorhome.

When the motorhome is finally situated, shift the transmission into park, set the foot-operated park brake, and then turn OFF the engine. Activate the air leveling system to level and stabilize the motorhome.

If the motorhome is to be powered externally, connect the 120 VAC power to the motorhome. If the motorhome uses LP gas, turn ON the LP gas valve at the LP tank. Connect the fresh-water supply and sanitize the water systems (see Chapter 0) as needed. Connect the waste drain hose to the external sewer hook-up. Start the refrigerator, water heater, and furnace, as warranted. Light the oven pilot light, as

SAFETY

needed. Certain appliances, such as the refrigerator, will not work properly, if the motorhome is not level, so be sure to complete the motorhome-leveling process before activating any of the appliances.

TOWING HITCH

The motorhome is fully capable of towing typical motor vehicles.

The BYWAY is equipped with a 5,000 pound towing hitch (Figure 0-10), and associated wiring connector.

The towing hitch features a standard 7 pin wiring connector. If desired, a trailer brake actuator can be added. The plug for the actuator is located to the left of the steering column, underneath the dash.

The motorhome is capable of towing light loads, and instructions are found in the chassis manufacturer's literature in the Owner's Information Package provided with the motorhome.

The total weight of the motorhome and any vehicle towed by that motorhome must not exceed the Gross Combined Weight Rating (GCWR).



Figure 0-10: Towing Hitch

NOTICE

When the motorhome is being weighed, account for passengers and their locations in the motorhome.

The tongue weight must not exceed 10 percent of the towing capacity. Information related to the motorhome weight and GCWR can be found on a sticker inside the motorhome closet. Any vehicles to be towed by the motorhome must have adequate active braking.

Tiffin Motorhomes does not recommend using any type of hydraulic towing lift that attaches to the rear of the motorhome designed to carry motorcycles, scooters, golf carts, etc.



HEATING & AIR CONDITIONING

Chapter

3

HEATING & AIR CONDITIONING

FURNACE

NOTICE

NEVER attempt to modify the furnace. Doing so might cause fire, explosion, carbon monoxide poisoning, or asphyxiation. If the furnace is malfunctioning, immediately shut the unit OFF and call a trained service technician as soon as possible.

The BYWAY is equipped with a forced-air furnace fueled by LP gas. The furnace is controlled by the wall-mounted Thermostat Controls System (Figure 0-1), located inside the main hallway of the coach. Among other functions, this controls both the heating and air conditioning for the motorhome.

In the gas-heating mode, the furnace heats air, which, in turn, is circulated through ductwork in the floor of the motorhome. If any obstructions block the floor vents or air-return register, the furnace will not function properly. Any items stored under the cabinets must be carefully stowed to prevent damaging or crushing the furnace ducting or blocking the warm-air return.

NOTE: When a furnace is being used for the first time, there might be an initial “burn-off” of manufacturing compounds or residues left on the heat exchanger or in the ductwork, which could produce odors, fumes, and possibly some smoke. This is normal and should not cause concern, unless it persists for an excessive amount of time.

To minimize the after-effects of this “burn-off” process, the initial use of the furnace must be done with all the doors and windows open to permit normal air circulation to dissipate these odors and fumes.

For routine operation of the furnace, set the thermostat to the desired temperature setting and then turn the thermostat to gas heat. In about a minute, the furnace will begin to operate and warm or hot air will come through the ductwork.

To shut down the furnace, turn the thermostat to the OFF position. Even though the thermostat might be turned OFF, the furnace system will continue to run for about a minute or so to permit a gradual cool-down of the heating system, which is normal.

On a regular basis, thoroughly clean the complete furnace and air-tube passageways to remove dust, lint, and any other possible obstructions. Leak-test the entire LP gas system at least annually. Also, check and clean the air-blower system annually.

Any access hatches to the furnace are for authorized service personnel only, as there are no user-serviceable parts on the furnace. Accordingly, do not attempt to tamper with the interior of the furnace.



Figure 0-1: Thermostat Controls

HEATING & AIR CONDITIONING

NOTICE

Be cautious when washing the exterior of the motorhome. Water should never be sprayed directly into the furnace vent. Should any water be forced beyond the rain baffles into the furnace vent, the furnace might rust, which, in turn, might cause improper combustion and produce unwanted by-products of combustion.

Before the beginning of each travel season, the furnace must be thoroughly cleaned and inspected. Any obstructions, debris, or lint, which might obstruct free airflow or impede the operation of the air circulation system, must be removed. For example, accumulated dust or lint could possibly obstruct the orifices for the pilot light or might accumulate on the blower blades and unbalance the operation of the blower. Additionally, any debris in the ductwork, when heated by the furnace, could emit unpleasant odors or possibly become a fire hazard.

The furnace system must be periodically cleaned. Annual cleaning is recommended unless the motorhome is subjected to dust levels significantly greater than average, in which case more frequent cleaning is recommended. The Owner's Information Package provides recommended cleaning tips and procedures. When needed, a more thorough cleaning must be performed by a qualified service technician.

AIR CONDITIONING SYSTEM

The factory-installed air-conditioning system is designed for 120 VAC power supplied either from the external power cord or from the generator. For the best cooling scenarios, park the motorhome in a shaded location whenever possible and close drapes on the windows exposed to direct sunlight.

The air-conditioned, cooled air is emitted through the vents (Figure 0-2 to Figure 0-3), which are located in the roof throughout the entire coach along the passenger side. The return air vents run parallel, front to back, on the ceiling along the driver's side of the coach. The return air is vented through the A/C unit.



Figure 0-2: A/C Unit



Figure 0-3: Supply Vents
and A/C Unit

HEATING & AIR CONDITIONING

NOTICE

The air conditioning system is the major consumption device of electrical power in the motorhome. When this system is being used in an RV park, cumulative use of these air-conditioning systems by the resident vehicles can create a bigger demand for electrical power than is actually available. Accordingly, at times, a “brown-out” condition might arise. This is when the AC voltage normally available drops to a lesser value (e.g., 10-20% below normal or more).

“Brown-out” conditions cause appliances to draw greater currents to make up for the reduced voltage; thereby causing circuit breakers to trip or fuses to blow. Under such conditions, your own motorhome is not at fault; reset your breakers and/or replace your fuses. Should such conditions continue, reduce the electrical load (in this case, turn OFF the air-conditioning system for a while) or start the electrical generator.

THERMOSTAT CONTROLS SYSTEM

The following is an overview of how best to use the thermostat control (Figure 0-4). For more detailed instructions, refer to the thermostat literature in the Owner’s Information Package.

Select the desired function (e.g., A/C, FURN, or OFF).

Select the Fan Mode operation (AUTO) or set the Fan Speed operation (LOW or HIGH) to select the fan speed desired.

Press the Up or Down buttons to set the desired temperature for the motorhome.

NOTE: When the fan is on AUTO mode, the fan will turn on and off when the temperature reaches the desired setting.

When the fan is on LOW or HIGH mode, it will continue to run even though the compressor cycles on and off when it reaches the desired temperature.

If the motorhome temporarily loses its 110V power, the air conditioning system will resume operation at its last programmed setting once power is restored.

If 12V power is lost to the thermostat, it will automatically reset to 72 degrees once power is restored.



Figure 0-4: Thermostat

HEATING & AIR CONDITIONING

NOTE: There is a thermostat control for each air conditioning unit.



LPGAS SYSTEM

Chapter

4

LP GAS SYSTEM

LIQUID PROPANE (LP) TANK

The BYWAY is equipped with an American Society of Mechanical Engineers (ASME)-approved LP tank (Figure 0-1), which is equipped with an automatic pressure regulator. This tank contains liquid petroleum fuel under high pressure.

An LP gas-distribution system distributes the gas to those appliances using such in the motorhome.

The “heart” of this LP gas distribution system is the regulator and it should be adjusted only by a qualified service technician. Most of the problems encountered in lighting the pilots of these appliances are caused by regulator maladjustments.

The major component of the LP gas supply is a manifold pipe, which runs underneath the motorhome floor. From this manifold, the various gas appliances are connected by a rubber supply line.

Should any of the secondary tubing develop a leak, do not attempt to splice any of the lines. Instead, have a qualified service technician run a new length of tubing to the appliance of concern, and then have that line leak-tested before placing it in normal operation.



Figure 0-1: LP Tank

NOTICE

To remove, repair, or replace any gas-operated appliance, always close the main gas valve at the LP tank.



WARNING

When the motorhome is not being used, the main LP gas valve must be turned OFF. Also, turn OFF the main valve when the LP gas tank is to be refueled to avoid the possibility of ignition fuel fumes by the pilot lights. All gas valves on the gas-operated appliances with Direct Spark Ignition (DSI) should also be in the OFF position during refueling and/or maintenance operations. DO NOT store LP, diesel fuel, propane, butane, or other flammable liquids inside the vehicle as these represent a very real fire hazard and possible threat to life.

LP GAS SYSTEM

NOTICE

If a gas leak is noted or suspected, turn OFF the main valve and keep the LP gas system OFF until that system is inspected by a qualified service technician as soon as possible. Do not delay in addressing any possible gas leaks with appropriate service because of the inherent hazards to safety.

LP TANK FILLING AND MONITORING

Any LP gas tank associated with the motorhome must never be filled to more than 80 percent of its total capacity. Filling should always be done only when the motorhome is leveled. If the motorhome is not level, the tank might be overfilled (i.e., more than 80 percent of capacity) and, thus, present an unsafe situation. When the tank is full (80% of capacity) the SPYDER Control System will indicate that the tank is "FULL." For reference purposes, there are four horizontal on the single SPYDER gauge columns representing the approximate amount of fuel remaining in tank. The four columns shown to the left are representative of what the single column would look like at difference capacities.

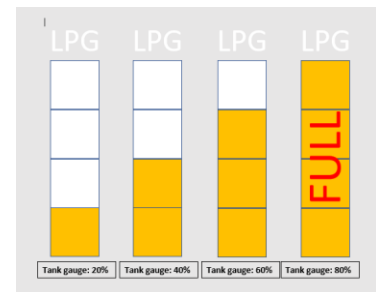

SPYDER Control showing approximate amount of LP Gas Remaining in Tank.

LP GAS REGULATOR

The LP gas regulator (Figure 0-2) is the "heart" of the LP gas distribution system. This regulator reduces and controls the pressure of the gas on the outlet end to provide a constant supply of gas at a constant pressure to the gas-operated appliances. The regulator has a vent to relieve excess pressure on the inlet side of the regulator, should excess pressure develop in the gas tank and connecting gas line to that regulator inlet. The vent would normally release the excess LP gas to the atmosphere until the over-pressurization condition is eliminated.

This vent should be regularly checked to ensure that it is not clogged or obstructed. If that vent is blocked from normal operation, component or system failures might result. If periodic visual inspection indicates any sign of corrosion or degradation, contact a qualified service technician to repair the regulator as soon as possible.

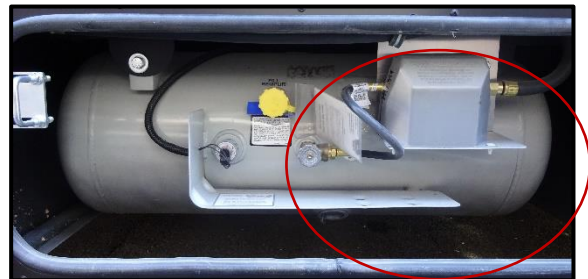

Figure 0-2: LP Gas Regulator

LP GAS SYSTEM



WARNING

DO NOT operate the LP gas system with any faulty component in place.

NOTICE

When an LP gas regulator is installed or re-installed, the regulator must always be installed with the gas diaphragm vent facing downwards. For more information, consult the manufacturer's literature in your Owner's Information Package that came with the motorhome.

Always keep the main valve to the LP gas tank closed when the system is not in use. When the LP tank is empty, keep the main valve closed until refilling is to be performed—this process will keep any moisture-laden air from back-flowing into the gas system and trapping unwanted moisture in the LP gas tank. If an empty LP gas tank has been exposed to the atmosphere for an extended time, let a qualified service technician purge the tank before its next filling operation.



MAJOR APPLIANCES

Chapter

5

APPLIANCES & ACCESSORIES

RESIDENTIAL REFRIGERATOR

Your RV contains the Standard style residential refrigerator (Figure 0-1), which is powered from an outside source or from the unit's generator or inverter, which uses a 12 volt battery power supply.

This unit operates as most home refrigerators do.

NOTE: While traveling, the refrigerator will be powered by the inverter.

For further operating and maintenance instructions, refer to the operating booklet found in the Owner's Information Package.

NOTE: While traveling, the 12 V battery is charged by the engine alternator.

The inverter must be ON for the residential electric refrigerator to operate, if not connected to shore power, or if the generator is not running.



Figure 0-1: Residential Refrigerator

ICE MAKER

Your ice maker (Figure 0-2), is equipped with an automatic shut off. As ice is made, the ice cubes will fill the storage tray, raising the shutoff arm to the OFF position. Do not force the wire shut off arm up or down.

- To turn ON the icemaker, lower the wire shutoff arm.
- To turn OFF the icemaker, lift the wire shutoff arm to the OFF position (arm up) until it clicks.

NOTE: The icemaker must have RV antifreeze cycled through it for proper winterization.

APPLIANCES & ACCESSORIES



Figure 0-2: Ice Maker OFF Position

MICROWAVE OVEN

The BYWAY contains either a microwave oven (Figure 0-3) which operates as a convection microwave. All microwave ranges operate on 120-volt AC electrical power, supplied either by the external electrical hookup or by the onboard electrical generator in the motorhome.

Touchpad controls are used for operating the convection microwave (i.e., cooking temperature, mode, power level, and cooking time). For basic operating instructions, care, and maintenance for the proper use of the microwave, refer to the specific manual in the Owner's Information Package.



Figure 0-3: Microwave

APPLIANCES & ACCESSORIES

AIR FILTRATION FAN



Figure 0-4: Air Filtration Fan

In the motorhome, the “exhaust” or air filtration fan (Figure 0-4) is built into the microwave, and its function is to filter the air and exhaust to the outside.

The air filtration fan must be used whenever cooking is performed to filter any airborne cooking residues and heated air.

The air filtration system can be used as supplemental filtration of other odors and gases including tobacco smoke, candle fumes, and related vapors. It contains filters, which can be removed and cleaned or replaced to ensure normal operation. Consult the particular owner’s manual contained in the Owner’s Information Package for more information.

APPLIANCES & ACCESSORIES

OPTIONAL OVEN AND/OR OPTIONAL COOKTOP

The BYWAY might be equipped with a standard recessed three burner cook top (Figure 0-5), or an optional, three-burner, recessed cooktop with oven (Figure 0-6).



Figure 0-5: Three-Burner Cooktop



Figure 0-6: Cooktop with Oven

To light the oven for the first time:

Light the oven (Figure 0-6) by turning the gas control knobs to the OFF position. Check that the main inlet gas valve is OPEN. KEEP THE OVEN DOOR OPEN for the full ignition process to view the pilot and burner until lit. Push and turn the gas control knob counter clockwise to position until pilot lights; you will hear a small clicking noise. If ignition does not occur in 5 seconds, turn the gas control knob off, wait for 2 minutes and repeat the lighting procedure. Once the pilot flame is lit, continue to hold the oven control knob in for 10-15 seconds, then release the knob and verify that the pilot stays lit.

After the pilot flame is ignited and the control knob is released, turn the control knob counter-clockwise to the required temperature setting. Within 20 seconds of the pilot flame being lit, the main burner flame will automatically ignite. Confirm with a visual inspection before closing the oven door.

To shut off your oven:

Push the oven control knob and rotate clockwise to the OFF position. Extinguish all pilots when refueling or traveling. The fan will continue to run for 10-15 minutes after turning off the oven. Do not attempt to adjust the oven pilot light, as it has been factory adjusted and factory set.

To extinguish the oven pilot light when use of the oven is concluded, push inwards on the oven control knob and turn that knob clockwise to the OFF position.

To operate the three-burner cooktop:

Ensure all cooktop knobs are turned clockwise to the OFF position. Push and turn the cooktop knob 90 degrees counter clockwise to the large flame icon. Push down on the cooktop knob and press the spark ignition button together to light the burner; continue to hold down the cooktop knob for 10-15 seconds to disable the safety cut off.

APPLIANCES & ACCESSORIES

The cooktop is fitted with a burner safety cut off. If a flame is not present, the gas supply will automatically shut off. If no spark is present when pressing the igniter, check or replace the AA battery. For your safety, never attempt to operate the cooktop with battery power exhausted.

NOTICE

It is wise to have a qualified service technician periodically check the entire LP-gas distribution system in the motorhome. Tiffin Motorhomes recommends scheduling an inspection annually. This would be a preventive maintenance routine for each motorhome owner.



WARNING

DO NOT USE cooking appliances as a heating source for the motorhome. Cooking appliances require fresh air for safe operation. Before using any cooking appliance, make sure that an overhead vent or window is open and/or turn ON an exhaust fan. DO NOT place stove covers on the cooktop until it is cooled.



DANGER

All LP gas-operated appliances in the motorhome will consume oxygen. If the motorhome is totally closed during such operation, the oxygen level might be reduced and the associated carbon monoxide level might be increased thereby causing possible harm or death to the occupants through asphyxiation. Always use these appliances with proper ventilation.

APPLIANCES & ACCESSORIES



WARNING

Portable fuel burning equipment, including wood and charcoal grills and stoves, should NEVER be used inside the motorhome. The use of this equipment inside the coach can cause fire or asphyxiation and could result in serious injury or death.



DANGER

**IF YOU SMELL GAS,
YOU SHOULD IMMEDIATELY:**

Extinguish any open flames, pilot lights, and all smoking materials. Do not touch or operate any electrical appliances or switches. Immediately shut off the gas supply at the main tank valve or supply connection. Open doors, windows, and other ventilation openings. Exit the RV to allow entrapped LP gas to dissipate. Have the LP gas system checked to locate and fix the sources of the leakage.

WATER HEATER



WARNING

DO NOT APPLY 110 VAC POWER to or LIGHT the water heater until after the water heater is filled with water and the water lines and heater tank are purged of any trapped air. Failure to do so will damage the water heater and might cause additional damage to the motorhome.

APPLIANCES & ACCESSORIES

Before the water heater is to be used, fill the fresh water system and purge the water lines to and from the water heater by opening all the hot-water faucets (Figure 0-7), until water steadily flows from each one and no spurting or hissing sounds are heard.

The water heater (Figure 0-8), uses either the LP gas system or the 120 volt AC electrical system to operate the heater.

Proper and safe operation of the water heater requires that all safety information provided in the owner’s manual be read and understood before placing the water heater in service.

Take the time to become familiar with this manual (provided in the Owner’s Information Package).



Figure 0-7: Water Heater

NOTE: When you turn ON the switch for the water heater, the middle red button will light up. It will go OFF after several seconds—this means the water heater is lit. However, if the light stays illuminated, then that means the water heater has not ignited.

LP Gas – Electronic Ignition Operation

For detail information on the water heater or specific information about select steps in operating the water heater, refer to the owner’s manual for this appliance contained in the Owner’s Information Package.

120 volt AC Electrical Operation

For detail information on the water heater or specific information about select steps in operating the water heater, refer to the owner’s manual for this appliance contained in the Owner’s Information Package.

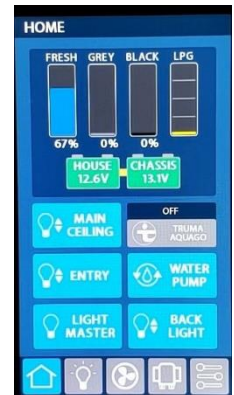



WARNING

DO NOT STORE any combustible or flammable substances near or adjacent to the water heater. Provide adequate space for ventilation and air circulation.

WATER HEATER STORAGE

If the motorhome is to be stored during the winter months, the water heater (Figure 0-8) should be drained to prevent damage caused by freezing water contained in the water heater.

APPLIANCES & ACCESSORIES

To drain the water heater, first turn OFF all electrical power, turn OFF the LP gas going to the water heater, then turn OFF the water pump. Open both the hot and the cold-water faucets to drain the water lines and open the drain on the water heater to drain the entire system.

When re-activating the water heater after the motorhome is taken out of storage, make sure that the entire water system, including the water heater, has been filled with water and the lines have been purged of any entrapped air before relighting the water heater. Failure to do so might allow the water-heating element to be turned ON before it is immersed in water; thereby, causing the premature failure of the heating element and voiding the warranty.



Figure 0-8: Water Heater



Figure 0-9: Water Heater Relief Valve

PRESSURE RELIEF VALVE

The relief valve (Figure 0-9) for over-pressure and over-temperature conditions is located on the exterior of the water heater. This valve will operate if the water temperature reaches or exceeds 210°F or if the water pressure reaches or exceeds 150 psig.

Since the water system in the motorhome is a closed system when all water valves are shut, the water heating cycle can raise the temperature and, consequently, the pressure, of the water in the water heater; thereby realizing pressure increases approaching 150 psig.

Should this pressure (i.e., 150 psig) be reached, the pressure-relief valve will begin “weeping,” that is, there will be minor dripping or leakage from that valve until the pressure drops below 150 psig, at which time the pressure-relief valve will reseal itself and restrict the water flow. This is normal operation and should not be a cause for alarm. Do not obstruct or block the pressure-relief valve in any way, as this would keep the valve from functioning normally and protecting the hot water system.



ENTERTAINMENTS

Chapter

6

ENTERTAINMENT

TELEVISION SYSTEM OPERATION

TELEVISION ANTENNA

You can automatically search for channels that are active in your area by editing and scanning channels on your remote control. To set up the television, refer to the television instruction manual provided.

NOTE: The antenna booster is located in the rear entertainment unit, and must be ON when using the antenna, and OFF when using cable.

NOTE: If the motorhome has been moved, the channels must be rescanned on each TV.

NOTE: Due to Tiffin Motorhomes' commitment to continuous research and development, some units might also contain televisions manufactured by other companies (LG, Samsung, etc.). Refer to the information in your Owner's Information Package on setup for the brands.

TELEVISION SATELLITE DISH (OPTIONAL)

Your motorhome might be equipped with an in-motion TV satellite dish control system (Figure 0-1) to permit access to satellite television. If so, the satellite will be equipped with a standard, non-high-definition receiver.

If your motorhome is equipped with an optional satellite dish, it is capable of receiving High Definition (HD) satellite signal from Dish Network. However, you must subscribe to HD service.

The dome satellite, on top of the coach, can be raised to allow easy access to change switches to a new satellite provider.

Follow the directions in the Owner's Manual for this dish-control mechanism to obtain the best orientation of the satellite dish for desired television reception.



Figure 0-1: Dome Satellite

ENTERTAINMENT

To set up your satellite receiver for Dish Network (Factory Configuration):

Remove the satellite dome cover on top of the motorhome by releasing the screws around the dome.

Change dish settings to 4-7-8 by adjusting the dipswitches to the DOWN position (8 is already in the DOWN position).

Re-install the dome.

On the Dish remote:

Press MENU.

Press the no. 6 button.

Press the no. 1 button.

Press the no. 1 button again.

This will bring up the Dish screen. Go to the right-hand column where it says "CHECK SWITCH."

Once this is done, EXIT the system, then press 0-0-0 to download the information.

TELEVISION SETS

Your motorhome is High Definition (HD) ready and is capable of receiving channels that are broadcasting in High Definition.

In order to receive a clear picture from your satellite dish, you must subscribe to High Definition (HD) service. Your motorhome does not feature a manual switching box; therefore, in order to change from satellite to DVD or TV antenna, follow the directions listed below:

To change the mode of your television, press INPUT on your remote control. Then, select TV, Blu-ray, or Satellite, and press OK.



Figure 0-2: Living Area Television Set

NOTE: The booster must be ON for the antenna and OFF for the cable. The television sets (Figure 0-2) are located in different areas of the motorhome. All TV sets are High Definition.

The televisions are powered by 120-volt AC electricity; therefore, the motorhome must either be plugged into an external source of AC power or using on-board power from the generator. An optional inverter would also permit the 12-volt DC power to be converted into 120 volt AC for the televisions.

Detailed operation of the televisions is provided in the accompanying owner's manuals found in the Owner's Information Package included with the motorhome.

ENTERTAINMENT

INFRARED REPEATER

The motorhome features an infrared repeater, which enables the owner to utilize the satellite remote control from various areas of the coach. An infrared repeater will be located in the bedroom and by the overhead TV located in the driver's area. If your motorhome has the optional outside entertainment system, this feature will be located on it also.

To utilize the infrared repeater, locate the one inside the cabinet that contains the DVD player. Peel the adhesive backing from the back of the infrared repeater and line the infrared repeater against the satellite receiver's infrared repeater. This will allow the infrared repeater to operate when the satellite remote control is directed toward the infrared repeater situated next to the TV.

You will now have the convenience of changing the satellite receiver channels from various areas of the coach.

NOTE: The infrared repeater will not work with a Dish Network receiver.

BLU-RAY PLAYER

The standard Blu-ray player (Figure 0-3) is located in a cabinet on the passenger's side at mid coach under the TV.



Figure 0-3: Sound Bar

The player allows accessibility to play, Blu-ray, iPods, and other electronic devices as well as viewing photos and playing music.

Detailed operation of the player is provided in the accompanying manuals found in the Owner's Information Package included with the motorhome.



CABINETS & FURNITURE

Chapter

7

CABINETS & FURNITURE

CABINETS

Your BYWAY contains cabinetry (Figure 0-1) installed throughout the entire motorhome from the driver's area, through the kitchen/dining areas, and back into the bedroom.



Figure 0-1: Cabinets

The cabinetry has been designed and built to provide ample storage space, to be easily accessible, and to be conveniently located to support the areas of concern.

Construction of these cabinets incorporates various hardwoods, raised panels, cabinet doors, and supports. Door pulls, handles, and knobs are installed in a style complementing the particular décor of each motorhome so that an aesthetically pleasing, as well as fully functional, storage capacity is realized.

For the many floor plans available in the BYWAY product line, cabinet design has been optimized to provide maximal storage for each floor plan available. Accordingly, the BYWAY can readily accommodate the routine materials, supplies, and customer-specific items desired for any travel requirements.



Figure 0-2: Kitchen Countertops and Backsplash

These cabinets are designed to contain stored supplies quite securely during travel to minimize or eliminate the possibility of shifting or spilling of cabinet contents during travel. However, when the motorhome is parked, all stored items are readily available in the cabinets for the convenience of the users.

As the storage requirements will vary somewhat from one floor plan to another, general observations can be made about the Tiffin-supplied cabinetry, which might or might not be applicable for your specific motorhome configuration.

CABINETS & FURNITURE

Cabinets are provided in the kitchen/dining area (Figure 0-2) to accommodate the routine cooking utensils and groceries normally required for travel. Storage space within these cabinets has been designed to accommodate the typical sizes and configurations of food supplies (e.g., cereal boxes, condiments, canned goods, bottled liquids) normally taken on travel trips.

Based on Tiffin Motorhomes' extensive experience with travel requirements of the seasoned motorhome users and from Tiffin Motorhomes' own research and development in cabinet design requirements, the cabinets offer the greatest storage capacity possible.

In the bathroom and bedroom, additional cabinets are available for storage of sundries and toiletries specific to these areas.

In the kitchen, a color-coordinated countertop is provided on top of the floor-mounted cabinets. To maintain the appearance of the countertop, clean with a damp cloth. If spotting occurs, clean the countertop with a damp cloth and a mild liquid soap. Should some dried-on residue still persist, let a damp cloth moistened with the liquid cleaner stand directly on top of that residue for 15-30 minutes to loosen the residue, then clean that spot accordingly.

NOTE: Strong chemicals, solvents, and cleaners (e.g., oven cleaner) might damage the surface; so do not use any products not specifically designed for countertop cleaning.

The countertop (Figure 0-2) might be physically damaged, too, if proper care is not taken. Do not cut anything (e.g., vegetables, fruits) directly on the countertop; rather, use a cutting board on top of the countertop to provide necessary protection. Excessive heat might also damage the countertop; therefore, any pots or pans taken directly from the range or oven must not be placed directly on the countertop; rather, use trivets or some other form of fireproof heat insulators to hold very hot pots or pans on the countertop.

All drawers are equipped with metal slides to provide additional load-bearing strength, and to permit effortless opening and closing of the drawers, even when they are fully loaded. These metal guides have a slight "locking" action, when closed.

As this cabinetry is typically of furniture-grade quality, any commercial furniture polish or cleaner can be used. Do not try to soak these wooden surfaces with water or any other liquid; be sure to wipe up spills or residues of any fluids that contact these surfaces to preclude any staining or discoloration of the cabinet surfaces.

CABINETS & FURNITURE

FURNITURE

KITCHEN, LIVING & DINING AREAS

On the BYWAY, a built-in dinette booth (Figure 0-3) is standard.

This dinette provides additional storage under the seat area of the booth, in addition to providing additional sleeping facilities.

To convert the dinette into a bed:

Remove seat back and side cushions.

Slide seat bottoms back.

Flip the lever underneath the table to release the table down.

Reinstall the seat back cushions and back rests to make up the mattress for the bed.



Figure 0-3: Dinette Booth

The living room contains a two-section sofa (Figures 0-4), with the double cushion side converting into a bed.

The sofa is custom coordinated with the décor of the motorhome.

To convert the sofa into a bed:

Remove the two accent pillows.

Under the seat cushions pull upwards on the very bottom portion of the sofa—this will cause the sofa seat to open, extend, and convert into a bed.



Figures 0-4: Sofa

CABINETS & FURNITURE



Figure 0-5: Passenger Chair
(swivel to the living area)

The driver's seat (Figure 0-5) is 6 way electric and manually swivels feature.

When the motorhome is parked, the driver's seat can be swiveled to face into the living room. To swivel this chair, first extend the slide-out room (see Chapter 0). Then, move the chair backwards as far as possible to gain clearance from the steering wheel. Now the chair can be swiveled without interference.

The passenger's seat is also an electric-powered, six-way seat having essentially the same controls as that of the driver's seat, and it is operated accordingly.

BEDROOM AREA

If a décor-coordinated, quilted bedspread with accessorized pillow shams and accent pillows (Figure 0-6) are included with the bedroom suit, Tiffin Motorhomes recommends that the bedspread be only dry-cleaned to preserve the quality of the bedspread for the longest time possible.

Treatment of the bedspread with any of the stain-resistant sprays (e.g., Scotchgard, etc.) will also make the bedspread more resistant to stains and fabric damage and, thus, provide many years of dependable service.



Figure 0-6: Bedroom Décor



STRUCTURAL FEATURES

Chapter

8

STRUCTURAL FEATURES

CHASSIS FEATURES

The chassis of your Tiffin Motorhomes BYWAY was built by and is warranted by Freightliner. The operating instructions for the chassis are included in the Chassis Owner's Manual, which is provided with your BYWAY and is a part of the Owner's Information Package furnished to you by your Tiffin Motorhomes dealership.

Before you begin using your BYWAY, read and follow all recommendations for the proper care, operation, and maintenance of the chassis—this will ensure a pleasant, trouble-free use of the vehicle. If you have any questions about the chassis, however, contact your chassis manufacturer.



ELECTRICAL FEATURES

Chapter

9

ELECTRICAL FEATURES

GENERAL INFORMATION

There are two electrical systems in your motorhome. These are the 12-volt DC (VDC) system and the 120-volt AC (VAC) system. Most standard appliances require the 120 VAC system, while the majority of the lighting systems used in the motorhome use the 12 VDC electrical system.

The electrical power for the 12 VDC system is supplied by the batteries of the motorhome. Those batteries are charged by a power converter. The alternator also charges the batteries when the engine is running.

The electrical power for the 120 VAC is supplied by the power cord when the motorhome is connected to an external power source or when the on-board electrical generator is in operation. The converter/inverter can also supply 120 VAC electrical power (to limited outlets and limited appliances)—the inverter transforms the 12 VDC electrical power from the batteries into the 120 VAC electrical power for the basic appliances.

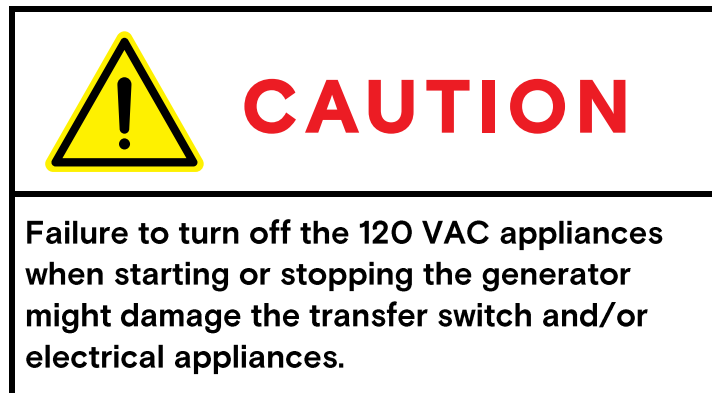

To connect the motorhome to an external source of 120 VAC electrical power, Tiffin Motorhomes recommends that all of the circuit breakers be in the OFF position, (this is done to prevent any power surge when connecting the motorhome to the external power source), and then unwind the power cord from the electrical compartment located in an external compartment. The standard, flexible, power cord supplied with the motorhome is designed to handle up to 50 amperes. Make sure that the pins in the male end of the plug are oriented correctly so that they match the power cable, and that they are in good condition (i.e., are not bent or damaged).

If there is a circuit breaker switch at the “plug” end of the power cord, that breaker must be turned OFF before making the connection. Insert the plug into the mating outlet, and then turn the circuit breaker ON. Close and lock the electrical compartment door to protect the contents and to keep them clean and dry. Close the cover on the power box, if so equipped, to avoid an unintentional disconnection and to keep the contents clean and dry. Then switch the main breaker to the ON position.

When properly connected, the 120 VAC system provides power to all the 120 VAC circuits and outlets when the main breaker is turned ON.

ELECTRICAL FEATURES

SPYDER CONTROLS SYSTEM

The 12 VDC system in your coach is controlled by the Spyder Controls Multiplex System. This electronic command center has an easy-to-read touchpad screen (Figure 0-1), that enables you to control features throughout the coach. Through 6 tabs, (home, lighting, battery, thermometer, slide-outs, and settings) this control system enables you to control almost every electronic feature inside your coach. It even enables you to control outside awnings and lights. As shown in the following figure, you are able to view tank levels, lighting controls, water heater controls, temperature, and much more.

For detailed instructions and videos on the Spyder Controls System, visit www.spydercontrols.com (Figure 0-2).

Click on the Customers tab at the top.

To access text and audio files, use the following information:

Username: Tiffin

Password: Motorhomes



Figure 0-1: Spyder Controls System

NOTE: Both username and password are case sensitive.



Figure 0-2: Spyder Controls Home Screen

ELECTRICAL FEATURES

MULTIPLEX SYSTEM

The multiplex system (Figure 0-3) enables you to control circuits from multiple locations in the coach. Each switch enables you to turn a circuit ON or OFF with individual button presses, and provides an indicator light to determine the status of the circuit (ON or OFF).

Additional features of the multiplex system include the following:

- **Master Feature** (this is only on the control panel located at the entrance door) — Enables you to turn all lighting circuits ON or OFF by pressing a single button labeled Light Master. Pressing the Light Master OFF switch will turn off all the interior lights within the coach. Momentarily pressing the Light Master ON switch will turn on the same circuits that were on when the Light Master OFF switch was pressed. Light Master OFF remembers which lights were on when the switch was pressed and will turn those same lights back on when the Light Master ON switch is momentarily pressed. Holding the Light Master ON switch will turn on all interior light circuits.
- **Switch Panel Backlighting** — All of the switches are backlit to make the labels easy to read. If you desire to turn the panel lights OFF, a switch is conveniently located at the center of the coach labeled Panel Lights, which enables you to turn the back lighting ON, OFF, or DIM.
- **Status LED Indicator** — A green LED beside each switch indicates whether the load is ON or OFF. In some cases, certain switches such as Awnings, Compartment Locks, and Generator do not have a status indicator at the switch.



Figure 0-3: Multiplex System Switch Panel

WIFI ANTENNA (OPTIONAL)

Your motorhome is equipped with a WIFI antenna (Figure 1) to permit access to local unlocked WIFI signals. You can also purchase data packages from the antenna manufacturers. Please see their manuals or websites for more information. Remember. In amplifying any poor signals, the amplified signal will be minimal.



Figure 1: Open Road Mobile

ELECTRICAL FEATURES

ELECTRICAL CAUTIONS



CAUTION

- Careless handling of electrical components can be fatal. Do not touch or use electrical components or appliances while feet are bare, hands are wet, or standing in water or on wet ground.
- Do not touch an extension cord to the utility power cord.
- Avoid overloading circuits and replace fuses or circuit breakers with those of the same size and amps only. **DO NOT** use a higher rated fuse or breaker.
- Do not plug the utility power cord into an outlet that is not grounded.
- Do not adapt a plug to connect to a receptacle that it is not designed for.
- Be sure that all electrical appliances used inside the motorhome contain three-prong plugs for proper grounding.
- Use caution when handling or working near electrical storage batteries.
- Always remove jewelry and wear protective clothing and eyewear when working on an electrical matter.

CIRCUIT BREAKER BOXES

For the BYWAY, interior 120 VAC and 12 VDC breaker boxes (Figure 0-4) vary depending on your specific floorplan, however, they are located inside the motorhome

The circuit breakers and associated fuses are installed to protect the electrical system of the motorhome from any overloads. Do not attempt to change the electrical circuitry or to add appliances yourself.

Consult an authorized Tiffin Motorhomes representative to determine whether any changes you desire are appropriate and acceptable.

The 12 VDC breakers are located in a compartment adjoining the 120 VAC breakers.



Figure 0-4: Circuit Breaker Boxes

ELECTRICAL FEATURES



WARNING

To protect the 12 VDC system, DO NOT STORE anything in circuit panel compartments (e.g., toolbox), which might jostle around, break through the shield, and short out the 12 VDC system. If this system were short-circuited, extensive damage and/or fire could result.

120 VOLT (VAC) AC RECEPTACLES

Your motorhome is equipped with several 120 VAC receptacles (Figure 0-5) located throughout the interior of the motorhome. These 120 VAC receptacles are of the “three-prong” variety; the third prong being a grounding pin that provides adequate grounding to protect one from any electrical shock.

For these receptacles to work properly, do not use an adapter, cheater, or extension cord, which defeats the function of the grounding pin. For the same reason, never remove or bend away the ground prong or pin from any three-prong AC plug so that it would fit a two-prong AC receptacle (i.e., an ungrounded AC receptacle).

Never operate the motorhome if there is an electrical short present, as an electrical short might deliver an electrical shock to anyone coming in contact with the exterior of the unit.

If you feel even the slightest of electrical shock, immediately disconnect the unit from the 120 VAC power source and locate the electrical fault (i.e., typically, it is a break in the grounding circuit).

Do not reconnect the 120 VAC power until after the electrical fault is fixed—the grounding circuit must be continuous from the frame to the distribution panel, to the power cord, and to the earth ground so that electrical-shock protection is realized.



Figure 0-5: 120 VAC Receptacle

ELECTRICAL FEATURES

GROUND-FAULT-CIRCUIT-INTERRUPT RECEPTACLES

In the kitchen and bath areas, there are 120 VAC GFCI receptacles (Figure 0-6), which provide greater protection against inadvertent electrical shocks.

These specialized GFCI receptacles provide both overload and short-circuit protection for the user. The electrical receptacles located in the slide-out are wired through the kitchen GFCI. The exterior receptacles are wired through the bathroom GFCI.



Figure 0-6: GFCI Receptacle

If an appliance plugged into a slide-out or exterior receptacle is not working, check for a tripped GFCI in the kitchen or bathroom.

All GFCI-protected receptacles are marked as such, but only one of them might have two pushbuttons on the receptacle (as shown in the picture). The upper pushbutton is a “test” button, which can be used to ensure that the GFCI function is working.

To reset this GFCI breaker, push the lower button (the “reset” button) to restore power to all the GDCI receptacles on this circuit.

These receptacles protect the user from ground faults between an electrically “hot” wire and ground. The GFCI will not reduce the shock hazard if the short is between a neutral and “hot” wire, or two “hot-load” wires.

The GFCI must be tested at least once a month. The 120 VAC electrical system must be ON for the GFCI to be tested.

To test the GFCI, the reset button must be pushed in fully before starting the test. Push the test button; this will cause the reset button to pop out, which means that the protected circuits have been disconnected. Push the reset button back in until a “click” is heard—this will reactivate the protected circuit. If the GFCI is working properly, the reset button will remain in the “in” position.

CONVERTER/INVERTER

A converter/inverter (Figure 0-7) is provided as a standard feature on the BYWAY. This converter/inverter provides these three basic functions:

Convert 120 VAC power into 12 VDC power when 120 VAC is available. The converter will create 12 VDC to charge the house batteries when 120 VAC power is available from shoreline or the generator. Please check the manufacture’s operations manuals for details.

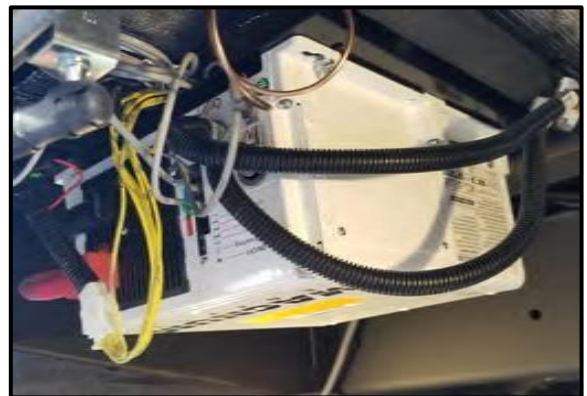

Figure 0-7: Converter/Inverter

ELECTRICAL FEATURES

Invert 12 VDC power into 120 VAC power when 120 VAC is not available. The inverter can create 120 VAC to power the entertainment system (e.g. TVs, Blu-ray player) and optional residential refrigerator when 120 VAC power is not available.

Transfer 120 VAC power to the inverter loads (e.g. entertainment system, optional refrigerator) when 120 VAC power is available.

The converter/inverter will transfer, or pass, 120 VAC power to its loads when plugged into shoreline or running the generator.

The converter/inverter is conveniently located in one of the compartments located beneath the motorhome. Do not store items around the inverter as these items could cause accidental electrical short circuits or obstruct the cooling fan leading to overheating.



Figure 0-8: Remote Panel

On the front face of the inverter remote panel (Figure 0-8), there is a green LED labeled CHARGING/INVERTING, and a small grey button labeled POWER ON/OFF. When the unit is inverting, the green status LED will blink once every second. When the unit is charging, the green LED will light up solid green if the unit is bulk charging, blink once every second when absorb charging, and blink once every eight seconds when float charging. Refer to the manual for your inverter model for more information.

The POWER ON/OFF button can be pressed and released to turn the inverter ON and OFF. Note that this will not turn off the charging function, or restrict power transfer when the converter/inverter is connected to a 120 VAC source.

The POWER ON/OFF button is also used to perform a soft reset of the inverter. Before performing a soft reset, disconnect the unit from any 120 VAC source, as leaving it connected during a soft reset might cause damage to the converter/inverter. Press and hold in the button for 15 seconds until the green status LED starts blinking rapidly. Release the button and the LED should go out. Press and release the button to complete the soft reset.

The 12 VDC wiring for the converter/inverter comes from the circuit breaker located underneath the step cover next to the house batteries. Check this circuit breaker if converter/inverter functions are not working.

The 120 VAC wiring for the converter/inverter comes from a circuit breaker in the circuit breaker box. This is the 120 VAC power that goes into the converter/inverter. There is also a 120 VAC wiring from the converter/inverter returning to a circuit breaker in the circuit breaker box. This is the 120 VAC power that comes out of the converter/inverter used to power the inverter loads. Check these circuit breakers if converter/inverter functions are not working.

There are two circuit breakers located in the 120-volt circuit breaker box inside the motorhome, which are labeled Inverter In and Inverter Out. Make sure these breakers are in the ON position. The inverter control is located in a cabinet above the driver's seat. For more information on this feature, consult the Magnum owner's manual.

ELECTRICAL FEATURES

ELECTRICAL GENERATOR

The 8.0 KW electrical generator (Figure 0-9) is located by opening the front hood of the motorhome. To open the hood, use the hood handle located in the first driver's side compartment (Figure 0-10).



Figure 0-9: Electrical Generator



Figure 0-10: Hood Handle

Before starting or stopping the generator, make sure that all the 120 VAC appliances are turned OFF.

After the generator has been started, wait until the transfer switch has connected before turning ON any of the appliances.

The generator can be started from either the remote-start switch located on the dash or directly at the generator itself. The hour meter installed on the generator records the number of hours of operation of the generator motor—this elapsed time is needed for observing necessary maintenance schedules on the generator.

For more detailed operating instructions and to determine necessary preventive maintenance schedules and procedures, review the manufacturer's owner's manual.

	CAUTION
Failure to turn OFF the 120 VAC appliances when starting or stopping the generator might damage the transfer switch and/or electrical appliances.	

AUTOMATIC TRANSFER SWITCH

The automatic transfer box switches 120V AC power from the shore or generator to the coach's main distribution panel. The transfer box has a delay of around three seconds before switching power to the shore, and a delay of around 30 seconds before switching power to the generator.

ELECTRICAL FEATURES

If the unit is plugged into the shore but there is no power to the coach, then make sure the shore outlet has power. If power is present, this might indicate that the unit is sensing an open neutral condition. Start the generator; if the power is restored, then either the shore plug or the outlet might be defective (the neutral line might be broken).

If there is no power to the coach from the shore or generator, then check the generator circuit breaker. If the circuit breakers are not tripped in the generator or the coach, the transfer box might need to be replaced. For more detailed information on the automatic transfer switch, refer to the specific owner's instructions found in the owner's information package.



CAUTION

Service to this box must be done by a qualified technician. DO NOT attempt to remove cover unless the shore cord is unplugged and the generator is off.

NOTICE

Be sure air conditioning units are off before connecting or disconnecting to or from the shore power.

CIRCUIT BREAKERS

The 12 VDC circuit breakers (Figure 0-11) are located in an external storage compartment.

When the circuit breakers are shut down or electrically tripped, they must be manually reset. These breakers protect various electrical components throughout the motorhome. As needed, manually reset the circuit breaker or breakers as shown in the accompanying figure. When the breaker is tripped, it will be extended outward. To reset it, push the button back in.



Figure 0-11: Circuit Breakers

ELECTRICAL FEATURES



WARNING

Be careful when working around these connections, as an accidental electrical short to ground (i.e., momentarily connecting the “positive” or “hot” terminal to any part of the chassis) can be hazardous.

12 VOLT DC (VDC) RECEPTACLES

Your BYWAY is equipped with a 12 VDC receptacle conveniently located inside of the center console (Figure 0-12). This 12 VDC receptacle can be used for providing power to various items, such as cellular phones, personal computers, or portable communications equipment.

This receptacle is usually found on the bulkhead in front of the passenger’s seat so that it is conveniently available. This receptacle accommodates the “cigarette-lighter” type of connector.



Figure 0-12: 12 VDC Receptacle

USB RECEPTACLES



Figure 0-13: USB Receptacle

The motorhome is equipped with USB ports (Figure 0-13) conveniently located on the front dashboard and in the bedroom area as well as on the passenger console. These ports allow for easy access when charging cell phones, laptop computers, iPods, iPads, or tablets.

ELECTRICAL FEATURES

BATTERY INSPECTION AND CARE

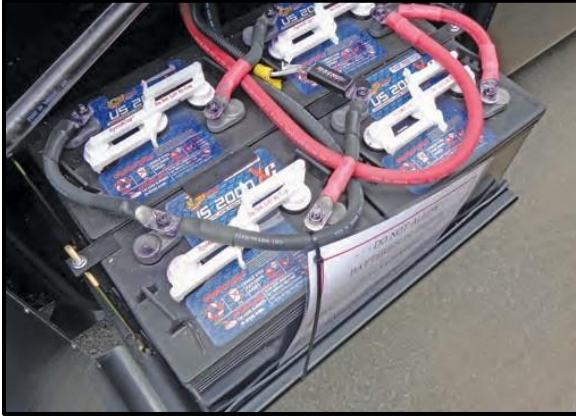

Figure 0-14: House Batteries

The motorhome batteries (Figure 0-14) are located on a sliding tray, which extends from an underneath compartment.

When batteries are not used for extended periods, they will gradually lose their electrical charge. Therefore, it is necessary to periodically recharge the batteries to increase the operational lives of the batteries.

It is also necessary to check the external condition of the batteries on a regular basis. Look for cracks in the battery case and cover. Check the vent plugs and replace them if they are cracked or broken. Keep the battery clean.

Since accumulations of dirt and acid residue around the battery terminals might provide an electrical path for discharging the battery, the area around the terminals must be cleaned periodically.

You can use an old toothbrush and a sparse amount of a diluted solution of baking soda (sodium bicarbonate) and water (distilled or deionized, preferred; tap water, acceptable) to clean and neutralize any acidic build-up around the battery terminals. If this is done and there is any foaming on the top of the battery, this indicates that acidic residues are being neutralized. Rinse the cleaned areas thoroughly with distilled or de-ionized water (tap water is okay, too).

Avoid getting the baking-soda solution into the battery fill plugs to each battery cell; this would drastically reduce the effectiveness of the battery (by neutralizing the sulfuric acid in the battery cells) or, worse, “kill” the battery. Dry the battery cables and terminals to prevent corrosion. To protect those terminals further, use a plastic ignition spray on the terminals. Do not use grease on the terminals, especially on the metal-to-metal connections, as grease might act as an insulator and keep the battery electrical power from entering the cables.

If the batteries are not going to be used for an extended period, remove them from the motorhome and store in a warm, dry place. Tiffin Motorhomes recommends that this service be performed by a qualified service technician, as the process is usually too complicated for the average owner to perform. For those who might wish to perform this service themselves, use the following procedure: Mark the battery cables (“+” sign or “red” for the positive cable; “-” sign or “black” for the negative cable) so that they can be properly reconnected again later. These batteries require periodic recharging to maintain their full charge.

ELECTRICAL FEATURES

Over time, the batteries will lose some of the water used with the sulfuric acid in the batteries. Following manufacturer's recommendations as found in the Owner's Information Package, periodically check the fluid levels in all the cells of the batteries (be sure to use safety eyewear during this process) and fill those that are low with water (distilled or de-ionized water is preferred; tap water is okay).

Do not overfill the cells; follow the filling directions exactly. Check the battery on a regular basis to realize the fullest service possible from the batteries over the longest time possible.

If the motorhome is to be stored for an extended period, disconnect the 12 VDC battery system—this procedure will prevent unnecessary drain and corrosion of the batteries and their terminals.

NOTICE

Disconnect the 120 VAC electrical power cord and the negative terminal from the coach batteries **BEFORE** working on the motorhome electrical system.

NOTICE

If the motorhome ever requires any welding operations on the frame, first disconnect the chassis batteries. Failure to do so will destroy all of the chassis computer system.



WARNING

Remove rings, metal watchbands, and any other metal jewelry before working around batteries. If any metallic object (tool, jewelry, etc.) contacts the positive battery terminal or any connection made to that terminal **AND** also contacts the negative terminal or any of its connections, a **SEVERE ELECTRICAL SHORT** will occur, which could result in an explosion, fire, and/or personal injury. Lead-acid batteries contain diluted sulfuric acid, which can be dangerous; avoid direct contact with any battery fluids. Wear eye protection.

ELECTRICAL FEATURES

HOUSE BATTERY DISCONNECT PANEL



Figure 0-15: House Battery Disconnect Panel

The house battery disconnect panel (Figure 0-15), is located in the cargo storage area on the driver's side. Along with the inverter switch and several breakers, the rotary switch labeled House Battery Master Switch can disconnect the house batteries when the vehicle is in storage for long periods.

Rotating this switch disconnects the house batteries only, not the engine batteries. This feature is designed to disconnect all 12 VDC circuitry from the batteries and prevent them from being drained during storage.

ENGINE BATTERY DISCONNECT PANEL

The engine battery disconnect panel is located in an outside rear compartment of the driver's side, above the engine batteries.

When the motorhome is removed from storage, rotate the upper left hand switch to reconnect the 12 VDC circuitry to the coach batteries and rotate the upper right hand switch (Figure 0-16) to reconnect the house battery. This will make the 12 VDC systems active again.

Turning the knob to the red disconnect position will turn off all power to the ignition side of the coach. If the coach is to be stored for an extended period, or if the engine is being serviced, Tiffin Motorhomes recommends that the disconnect be in the OFF position.



Figure 0-16: Engine Battery Disconnect Switch

ELECTRICAL FEATURES

12 VOLT DC DISCONNECT SWITCH

For routine short-term use, there is a 12 VDC disconnect switch (Figure 0-17) on the switch console located in the stairwell of the BYWAY. This switch can be used to disconnect the “house” battery from most of the 12 VDC circuits in the motorhome so that there is no inadvertent drain on the battery.



Figure 0-17: 12 VDC Disconnect Switch

AUXILIARY START SWITCH

The auxiliary start switch (Figure 0-17) is located on the switch panel to the left of the steering wheel in front of the driver’s-side console box.



Figure 0-18: Auxiliary Start Switch

This switch connects the motorhome coach batteries to the chassis batteries—this allows the chassis batteries to “borrow” power from the coach batteries to assist in starting the engine.

If the chassis batteries cannot start the engine by turning the ignition key, hold down the battery-boost switch for at least 60 seconds and retry starting the engine.

When attempting to use the auxiliary start switch function, Tiffin Motorhomes recommends that you press and hold the switch for about 60 seconds before trying to start the engine. This gives the two sets of batteries (house and chassis) a chance to equalize before engaging the starter. The multiplex system that controls most chassis functions will need to reach optimal voltage range to ensure proper operation as well.

SEVEN-PIN TOWING CONNECTOR

Your motorhome is equipped with a standard, 7-pin connector near the towing hitch at the rear of the motorhome to supply the necessary circuitry to control a towed vehicle.

The wiring of that connector is shown in the accompanying diagram (**Error! Reference source not found.**).

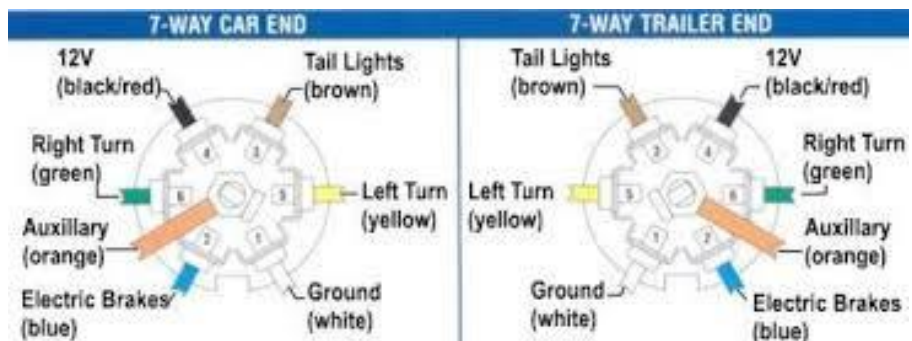

Make sure that any cable from the vehicle to be towed is wired correctly to mate properly with the connections shown in the connector. If in doubt about proper wiring, have a qualified service technician prepare and install the necessary cable to mate with the 7-pin connector on the motorhome to ensure proper operation subsequently when any vehicle is actually towed by the motorhome.

ELECTRICAL FEATURES

When the towed vehicle is uncoupled from the motorhome and the cable is disconnected from the 7 pin connector, be sure to close the spring-hinged cover plate on the connector to protect the contact pins from dirt or debris. In a similar manner, protect the cable end from similar damage, weather, or debris—one such method could be to place the connector end in a heavy-gauge plastic bag (e.g., polypropylene, polyethylene, etc.) and secure the bag tightly around the cable with a stout elastic band or tape and then mount the secured cable in a manner to keep it both from mechanical damage and water intrusion.

When the towed vehicle is again coupled to the motorhome through the towing hitch and the cable is again connected to the 7-pin connector, make sure the resultant connection is tight and solid so that the connection does not jar loose during use. Several supplemental methods to secure that connection have been used; some of which include securing the connection with a strong rubber band or with Velcro-type fasteners to provide a supplemental mechanical backup to the actual electromechanical connection. If a conversion adapter to convert the round, 7-pin connector to a flat, 4-pin connector is needed, purchase one from any RV after-market store.

SOLAR PRE WIRED

Your BYWAY is pre-wired for a GO POWER solar unit. This provides easier installation if you wish to add solar power to your unit in the future.

ELECTRICAL FEATURES

ELECTRICAL DIAGRAM

33AL

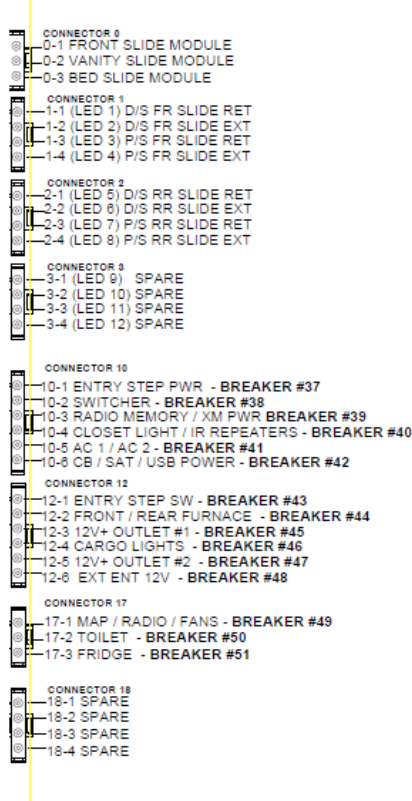

G6A CONTROL PANEL LAYOUT
 Tiffin PN: 5083668 Spyder PN: BENC254CL
 Bay - CHASSIS Rev 0VA
 PINOUT DIAGRAM - 04.01.2019
Back View

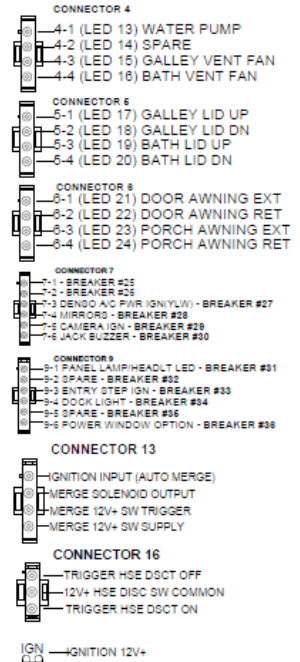
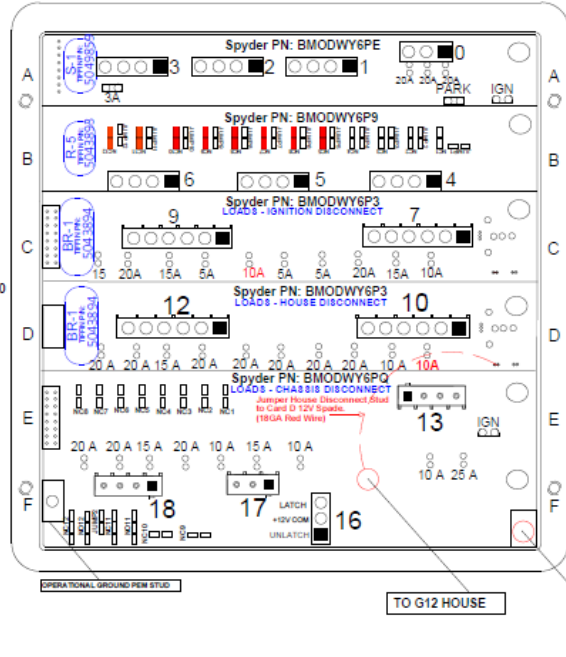

TIFFIN MOTORHOMES, INC.
 105 100 STREET NW - RED BAY, AL 35586
33AL CHASSIS G6

LPS Line Layout

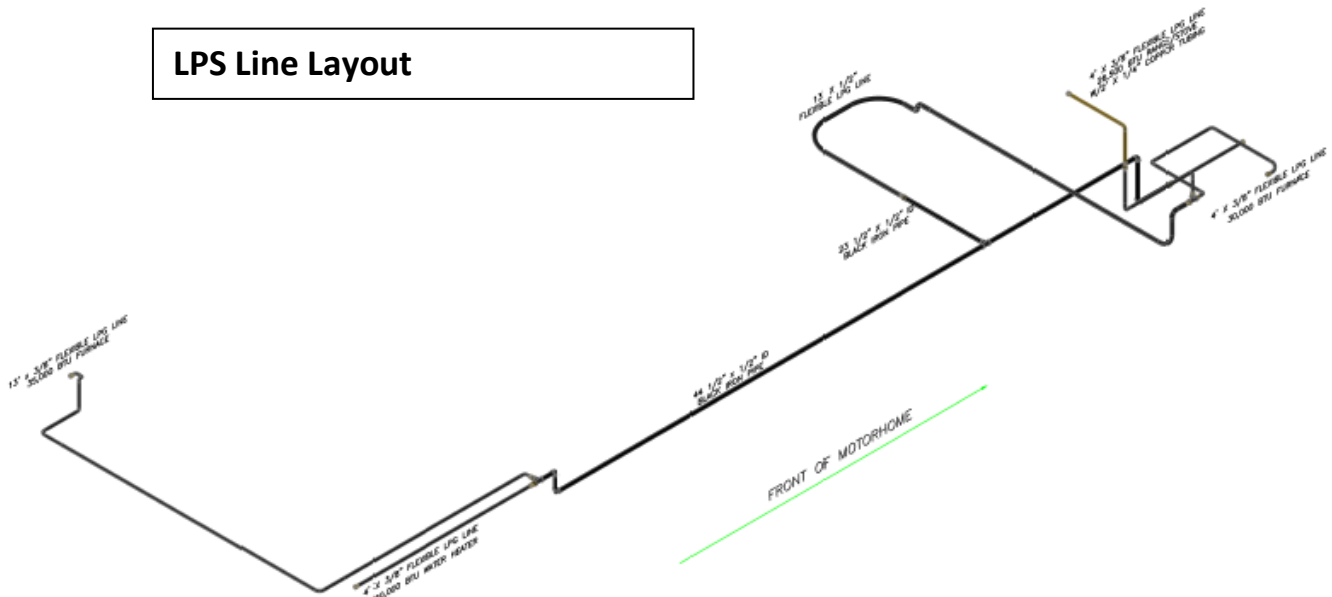



SLIDE-OUT FEATURES

Chapter

10

SLIDE-OUT FEATURES

SLIDE-OUT OVERVIEW



CAUTION

BEFORE ACTIVATING THE SLIDE-OUT FEATURES, read the slide-out instruction manual first. The motorhome must be parked, the ignition switch must be in the ON position and the leveling jacks must be used to level the motorhome PRIOR to activating the slide-out features. The emergency foot brake and parking brake must be engaged. Be sure the front driver's seat is moved forward before opening the slide-out.

GENERAL CONSIDERATIONS

NOTICE

The slide-out room requires semi-annual inspection to ensure that the slide-out mechanism is properly aligned and functioning correctly. Make sure that this inspection is performed every six months to correct any possible misalignments.

The slide-out-room feature is actuated by a screen on the Spyder Controls System (the third button down on the left of the control) (Figure 0-1). The switch must be manually held down in the desired position (either "in" or "out") to activate the desired action of the slide-out room and continue to be held down until the desired action is concluded.



Figure 0-1: Slide-Out Screen on the Spyder Controls System

Switches to operate the front slide-out rooms are located on the cabinet above the driver's seat. (Figure 0-2).



Figure 0-2: Front Slide-Out Switch

SLIDE-OUT FEATURES

NOTE: Releasing the switch before the slide-out is fully extended or retracted will stop the slide-out.

OPERATING PRECAUTIONS

Before the slide-out-room mechanism is used, make sure the motorhome is parked, and the leveling process has been properly completed. Verify that no obstacles (branches, trees, telephone poles, power/water hookups, trash bins, etc.) are within a five-foot space envelope of the slide-out room, to keep from damaging the slide-out room when it is finally deployed.

NOTICE

Before attempting to extend the slide-out room, check outside and make sure that there is at least a five-foot clearance around the area where the slide-out room will be extended, and be sure the driver's and passenger's seats are moved to the forward position.

EXTENDING THE SLIDE-OUT ROOM

All windows in the slide-out room (Figure 0-3) must be closed and secured before the slide-out room is to be extended or retracted. Also, any loose materials or possible obstructions, such as rugs or furniture must be removed from the immediate slide-out room area.

Make sure that the motorhome has been leveled, that the battery is fully charged and connected to the electrical system, and that the ignition switch is ON and the engine is running before attempting to use the slide-out features.

Verify that there are no obstructions outside, which might interfere with the operation of the slide-out room.

Before moving the slide-out room in either direction, make sure that the driver's and passenger's chairs are moved forward into the driving area as far as possible and locked into position.

Make sure the parking brake is engaged.

Push EXTEND on the Spyder Controls System, and allow the slide-out room to go to its fully extended position. When fully extended, release the switch.



Figure 0-3: Extend and Retract Slide-Out Room

SLIDE-OUT FEATURES

NOTE: The front slide-outs can also be operated by pressing the buttons located on the sides of the seats.

RETRACTING THE SLIDE-OUT ROOM

Before attempting to move the motorhome, the slide-out room must be fully retracted.

Verify that the 12 VDC system is fully charged and connected to the electrical system.

Make sure all personal equipment and any children are away from the slide-out.

Make sure all cabinet doors around the slide-out areas are closed.

Push RETRACT on the Spyder Controls System, and allow the slide-out room to go to its fully retracted position.

NOTE: The front slide-outs can also be operated by pressing the buttons located on the sides of the seats.

Release the switch (this locks the room into position).

NOTICE

If the slide-out room does not move when the switch is depressed, check the following:

- Make sure the ignition system is turned ON.
- Make sure the park brake is engaged.
- Make sure the battery is fully charged and connected.
- Make sure the slide-out breakers haven't been "tripped." These are located in the storage box with the inverter or converter.

SLIDE-OUT FEATURES

EMERGENCY SLIDE-OUT ROOM CONTROL OVERRIDE

If the switches for the slide-out rooms become disabled in the cabin of the motorhome, use the emergency override button for all slide-outs (Figure 0-4) that is located in the front driver's side compartment with the fuses for the motorhome. This override switch operates all slide-outs simultaneously. To retract or extend the slide-outs, a round dowel or cylinder (for example: barrel of a ball point pen) must be inserted in the holes marked RET or EXT.

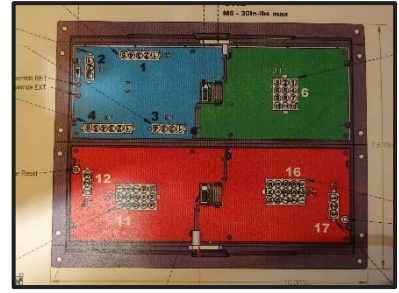

Figure 0-4: Location of Slide-Out Room Control Override behind the front panel.

SLIDE-OUT FEATURES



EXTERIOR FEATURES

Chapter

11

TOWING HITCH

On the rear of the BYWAY is a 5,000-pound towing hitch (Figure 0-1) capable of handling a tongue weight of 1,000 pounds.

This hitch is installed for towing a passenger car to be used when the vehicle is parked. The wire connector installed with this hitch is a standard 7-pin connector.



Figure 0-1: Towing Hitch

EXTERIOR SIDES



Figure 0-2: BYWAY Exterior

The sides of your motorhome (Figure 0-2) and the end caps are made of gel-coated fiberglass.

To clean these fiberglass surfaces, use only warm water and a mild cleanser; gently wash with soft cloths.

Use of stiff bristle brushes or other harsh abrasives might cause scratches on the fiberglass surfaces.

NOTE: Tiffin Motorhomes is NOT responsible for the weathering and/or oxidation of gel-coated surfaces.

Spacious storage compartments are located on the exterior sides of your motorhome. These external compartments provide ample additional space for your belongings while you are traveling. When stowing materials in these storage compartments, try to “balance” the resultant weight load from front to rear and from side-to-side. This will keep the center of gravity of the motorhome essentially unchanged and should not adversely affect the handling characteristics of the motorhome when it is in motion.

SECURITY LIGHTS

On the motorhome, exterior security lights (Figure 0-3) are standard features.

A light is installed on the passenger side of the coach to help light that side of the motorhome for added protection.

This light can serve as a “porch light” when the motorhome is parked and the awning is deployed so that various activities (e.g., sitting outside, grilling, visiting) at dusk and later can be enjoyed by the motorhome owners and their guests.



Figure 0-3: Exterior Security Light

ROOF & LADDER (OPTIONAL)

The BYWAY is manufactured with a fiberglass roof accessed by a ladder.

Proper care and routine maintenance of your roof will ensure many years of trouble-free performance.

The (Optional) On-the-Go Ladder is a fully adjustable and collapsible ladder with safety locks at each rung for extra security. The Ladder is designed to be used with the OEM-installed On the Go Receiver, but can be used without the Receiver as a lean-to ladder. Additional information about this product can be obtained from lci1.com/support or by using the LippertNOW app. Replacement kits can be ordered from <https://store.lci1.com/> or by using the LippertNOW app.



In the event you purchase a coach that did not receive the ladder option, You can order direct from Lippert Components. Aftermarket Part# 2021126697



CAUTION

Do not exceed the maximum rating of the ladder (i.e., 300 pound load limit).

Do not attempt to walk on the roof either while it is wet or when condensation is present from the air conditioning system as the roof surface will be quite slippery.



WARNING

REMOVE AND STOW THE LADDER PRIOR TO TRAVEL. FAILURE TO PROPERLY REMOVE AND STOW THE LADDER COULD RESULT IN PERSONAL INJURY OR PROPERTY DAMAGE.

ELECTRIC STEPS

The BYWAY is equipped with electric doorsteps (Figure 0-4).

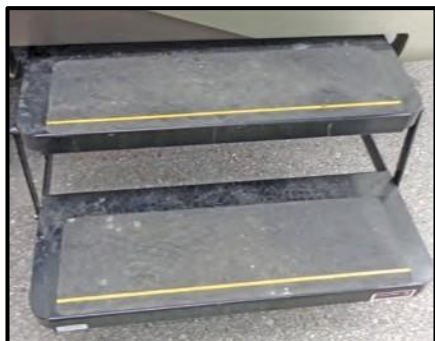

Figure 0-4: Electric Steps



Figure 0-5: Switch

The switch (Figure 0-5) to operate these steps is located in the passenger console box. When the power switch for the steps is in the ON position, open the door and the steps will automatically extend.

USING THE ELECTRICAL, DOUBLE-ENTRANCE, DOOR STEPS

With the step switch turned ON:

- Close the door. The step will retract and lock into the UP position.
- Open the door. The step will retract and lock into the DOWN position.
- Turn the vehicle ignition switch OFF and open the door. The step will extend and lock in the DOWN position.

With the step switch turned OFF:

- The step will remain in an extended position when the door is closed. Turning OFF the power with the step retracted will hold the step in a retracted position, as well.
- With the step extended, close the entrance door. Turn the vehicle ignition switch ON. The ignition override system will go into effect and the step will automatically retract.

NOTE: This feature is operational only the first time the door is opened after the vehicle ignition switch is turned OFF. When the ignition switch is ON, the step will always activate with the door movement, regardless of the position of the step power switch.

Other exterior features include optional power-assisted awnings (patio awning, door awning, or both). If available, they can be controlled from the switch console located in the stairwell of the motorhome.



CAUTION

DO NOT travel with the steps or awnings in the extended position. If the motorhome is driven with the steps or awnings in the extended position, there is the possibility of causing major damage to the steps or awnings, and to the motorhome.

NOTICE

If the door is opened and closed without allowing the step to extend fully and lock in the DOWN position, the step will retract and lock in the UP position. When the door is re-opened, the step will not extend. The power switch must be turned ON for the step to extend.



CAUTION

Always be sure to “look before you leap!” When opening the entrance door from the inside, be sure that the step has fully deployed before trying to step outside to avoid falling and possible injury.

MIRRORS



Figure 0-6: Mirror

This motorhome is equipped with remote-controlled, exterior rear view mirrors (Figure 0-6).

Always adjust the mirrors for maximum rear visibility before driving. If another driver is to drive, be sure the mirrors are readjusted to accommodate the second driver.

The mirrors are adjusted by using the multi-directional switch (Figure 0-7) located on the dashboard. Select the mirror to be adjusted by pointing the arrow in the direction of that mirror.

Move the control in the direction of movement desired to obtain the best view for that mirror. The adjustment control moves the top half of both mirrors. **The bottom half of each mirror is convex and is adjusted manually.**

Detailed instructions for these manual adjustments can be found in the manufacturer's literature available in the Owner's Information Package. However, this brief overview of mirror adjustment can begin the process: The top portion of the mirror must be adjusted horizontally so that you can see your own motorhome in the one-inch surface closest to the motorhome. The remaining portion of the mirror now enables you to see the road behind you. The mirror must be adjusted vertically so that you can see the rear bumper on the bottom of the plane portion of the mirror.

The convex mirrors must be adjusted horizontally so that you can see your own motorhome in 1/3rd of the mirror. These convex mirrors must then be adjusted vertically to allow you to see any other vehicles alongside your motorhome.

These mirrors also contain heating elements to defog or de-ice the mirror glass during cold weather operation. The red ON/OFF switch for this feature is located by the adjustment control. Further adjustment of the mirror might be necessary at the swivel portion of the mirror arm.

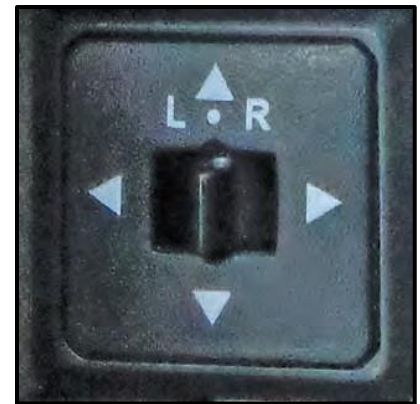

Figure 0-7: Mirror Adjustment Controls

NOTICE

Objects viewed in convex mirrors appear smaller and farther away than they actually are.



INTERIOR FEATURES

Chapter

12

INTERIOR FEATURES

BEDSPREAD

As a furnished part of the bedroom suite, a bedspread with matching pillow accessories (Figure 0-1) is included with the motorhome.

The bedspread and pillow shams are “for dry-cleaning only.” As the bedspread was made with materials treated for stain resistance, dry-cleaning will prolong the life of these materials. The curtains in the bedroom are color-coordinated with the bedspread and accessories to provide a pleasing décor for the bedroom area.



Figure 0-1: Bedroom Décor

FLOORING



Figure 0-2: Typical Flooring in the BYWAY

Vinyl flooring (Figure 0-2) is standard throughout the motorhome with the exception of the slide-out rooms, and the bedroom, which are carpeted. For routine cleaning, sweeping or vacuuming the floor would be sufficient. If more thorough cleaning is warranted, the flooring can be cleaned with a damp mop and water. For more stubborn stains, a mixture of soap-free household cleaner (e.g., vinegar, ammonia, or comparable products) and water can be used.

Do not saturate the floor surfaces with water, as this could damage the flooring substrate. Do not use any abrasives (cleansers, scouring pads, and the like) as they can scratch or mar the flooring surfaces and might cause damage to the flooring. If ceramic tile is chosen as an option, it may be cleaned more vigorously than the vinyl flooring.

CEILING/LIGHTING



Figure 0-3: Typical Ceiling in the BYWAY

The ceiling (Figure 0-3) in the BYWAY motorhome is covered with a padded-vinyl headliner, which can be easily cleaned with a damp, soft cloth, and a mild detergent.

Clean around all vent areas to prevent any build-up of dirt, grease, or other accumulations.

Lighting throughout the unit may be deemed to desired level by use of the Spyder Control System. (Figure 12.3)

INTERIOR FEATURES

WINDOW TREATMENTS

Throughout the BYWAY, the window treatments consist of two shades—solar and blackout (Figure 0-4).

The solar shade enables one to see out during the daytime, yet blocks most of the sunlight and heat from entering the motorhome. The blackout shade creates complete privacy for nighttime.

Each shade can be raised and lowered by pulling down on the shade.

The shades are located on all the windows in the living area and the bedroom. A single shade is located in the window above the kitchen sink and the bathrooms. The cockpit shades operate on a manual roller tube with a retention spring.

The front Windshield shades are operated by switches on dashboard.



Figure 0-4: Day/Night Window Shades



To operate the cockpit shades, pull the shade down to the desired level and slowly release to lock the shade in place. To retract, gently pull down on the shade and release.

ELEVATED BEDS CAUTION.



- **250 lbs. Max. load capacity**
- **Failure to comply with the load capacity could cause bed failure which may result in injury.**
- **Bed (s) must be stowed in the up position during travel.**

INTERIOR FEATURES

- **Elevated beds may present a fall hazard which may result in injury. Please consult the Owner's Manual for more information regarding elevated beds and the use of bed rails.**

Standard Elevated Beds – Various Tiffin products are equipped with standard built-in elevated beds or bed loft areas. These beds can be upwards of 4 to 5 feet above the floor level and are often enclosed on one, two, or three sides and sometimes even partially on a fourth side. Because there are so many potential users and different types of elevated bed designs, elevated beds are not equipped with bed rails.

Use of Bed Rails – We feel that you, as the customer, are best equipped to determine if a bed rail system is necessary or best for you based on your intended uses, the actual users of the elevated beds, and the comfort level of the users. For those customers who would prefer using an elevated bed with a bed rail, there are numerous bed rail styles, sizes, heights, and designs available, even in the style of bumpers, which can be purchased at various retail locations and/or on the internet.

When installing a bed rail please make sure that you follow the manufacturer's installation instructions carefully and that you take in to account the size and height of the mattress (either originally installed by Tiffin or later replaced by you) so that the rails are the appropriate height above the top of the mattress. This is important because residential mattresses differ in size from the RV mattresses originally installed by Tiffin. **Please also make sure that the bed rail you select allows for adequate room to get in and out of the elevated bed after installation, especially in the event of an emergency.**

Tips for Safe Usage:

- Please use sound judgment when allowing children to sleep in any style of elevated bed. Generally, it is not suitable for children under the age of 6 to sleep in an elevated bed or bed loft area.
- Discuss proper usage of any elevated bed/electric bed lift system with your children and make sure they are supervised if playing in the bedroom/sleeping area of the trailer with elevated beds. Please do not allow horseplay on or under the elevated beds and no items such as hooks, belts, jump ropes, or towels should hang from any part of the elevated bed.
- Place a night light in the bedroom/sleeping area so users can see at night when getting in and out of the beds.

No more than one person should be in an elevated bed at once and make sure you follow the weight restrictions posted on the warning label near the beds.



PLUMBING & BATH FEATURES

Chapter

13

PLUMBING & BATH FEATURES

FRESHWATER SYSTEM

TANK-LEVEL MONITOR

The tank-level monitor on the Spyder Controls System (Figure 0-1) is located in the hallway near the bedroom, and enables checking the approximate levels in the fresh, gray, and black-water holding tanks using the level monitors.

To use this monitor, press the Level Test button, and read the fresh, gray, and black-water tank levels.

The “empty” indicator light will momentarily light when the button is pressed. If the tank is full, all of the lights will be ON. Lights are sequentially arranged to indicate fluid levels in approximately third-tank increments. For example, if the tank selected is approximately two-thirds full, then the indicator lights “E” (for “empty”), “1/3”, and “2/3” will be lit.



Figure 0-1: Tank-Level Monitor

NOTE: The LP-gas level and battery voltage display for the chassis and house battery banks are available on the same screen.

KITCHEN SINK



Figure 0-2: Kitchen Sink

The kitchen sink (Figure 0-2) installed is a double-bowl sink equipped with a sink cover to provide additional counter space when the sink is not in use.

Wash only with mild detergents and water and using a soft cloth for subsequent drying and polishing.

PLUMBING & BATH FEATURES

BATHROOM SINK, SHOWER, & ACCESSORIES



Figure 0-3: Bathroom Sink and Faucet

The motorhome is equipped with a fiberglass shower surround and sink (Figure 0-3 and Figure 0-4).

Use fiberglass cleaning or mild cleaning supplies to avoid scratching its surface.

The typical bathroom accessories include a towel bar and a toilet paper holder.

The faucet in the bathroom was chosen to match the specified décor.



Figure 0-4: Shower

The tub faucet with showerhead, hose, and bracket are coordinated with the sink faucet.

SHOWERMISER

Your motorhomes is equipped with a SHOWERMISER. It simply connects to your shower outlet. By flipping a small lever, you are able to redirect the cold water from the shower that would normally go down the drain, back into the fresh water tank. With its unique and patented color-change ability, will notify you in under 4 seconds (at normal room temperatures) that hot water has arrived. Once the hot water is present, just flip the lever back to the showerhead and you have hot water ready to go.

NOTICE

Do not use the Showermiser when connected to city water. This will cause the fresh water tank to overflow.

PLUMBING & BATH FEATURES

WATER PUMP

The water pump is self-priming and totally automatic, operating on demand whenever water is required. The water pump is used to pressurize the freshwater system when the unit is not connected to city water. The switches are located in various conveniently located areas throughout the motorhome where water is accessible, or on the Spyder Controls System (Figure 0-5).

To start the pump:

Fill or partially fill the fresh water supply tank.

Open the kitchen and bathroom faucets.

Turn the water pump switch to ON and allow the water to fill to the water line and the hot water heater.

Close each faucet after it delivers a steady stream of water (close the cold-water faucet first). Leave the hot water faucets ON until they also deliver a steady stream of water. This procedure will ensure that the water heater is filled with water.



Figure 0-5: Spider Controls System Switch

The water pump will stop running once all faucets are closed. The water pump is now ready for automatic operation. The pump will run when a faucet is open and stop when a faucet is closed.

NOTICE

Never allow the pump to run for long periods of time without water being present in the supply tank, as doing so might cause physical damage or blow fuses.

If water does not flow when a faucet is turned ON while using the demand system, use the following troubleshooting chart:

SITUATION	SOLUTION
Pump running – no water	<ul style="list-style-type: none"> • Fill Tank • Clear the water line to the pump
Pump does not run	<ul style="list-style-type: none"> • Check the pump switch • Check the 12 volt fuses • Check the electrical connections • Check the battery

PLUMBING & BATH FEATURES

All the water must be drained from the freshwater system when the unit is not in use for extended periods. For more detailed information regarding the water pump, refer to the water pump manufacturer's brochure in your motorhome Owner's Information Package.

CITY WATER CONNECTION



Figure 0-6:
Motorhome
Water Hose

When connecting your unit to city water, use the water hose (Figure 0-6) manufactured and labeled for potable water service—this will ensure that the hose selected for use will not alter the taste of the water.

To connect the city water supply (Figure 0-7), connect one end of the hose to the city water supply.

Turn the city water supply ON for a few seconds to clear the line. Once the hose has been flushed, turn the supply OFF. Connect the other end of the hose to the city-water connections on the motorhome.

Once the city water fill valve is opened, water is supplied to the freshwater system including the hot water heater, faucets, and toilet. Turn ON the water supply and open all of the faucets to clear any trapped air within the plumbing lines within the motorhome.



Figure 0-7: City Water
Supply Connection

Once any air pockets have purged from the water lines and water flows freely, close all of the faucets. The city water supply is pressurized; therefore, the water pump is not needed when the water system of the vehicle is connected to the city water system.

NOTE: If city water pressure is more than 60 psi, Tiffin Motorhomes recommends using a water pressure regulator to prevent damage to the motorhome.

FILLING THE FRESHWATER TANK

The freshwater tank is normally filled from the city water connection. The yellow handle city water/tank fill valve determines whether the city water is going through the water system or into the freshwater tank. Since there is no automatic shut-off when filling the freshwater tank, check the level from the monitor panel while filling the freshwater tank on the motorhome.

The excess water will be vented from an overflow in the vent pipe onto the ground when the capacity of that tank has been reached. This pipe is installed in the freshwater tank to prevent possible tank rupture from inadvertent overfilling.

All of the water must be drained from the freshwater system when the motorhome is not in use for an extended period of time.

PLUMBING & BATH FEATURES

WATER FILTER



Figure 0-8: Water Filter

This unit is equipped with a water filter (Figure 0-8), which must be removed before disinfecting the fresh-water system.

First, remove the water filter and then replace cover to allow the sanitizing solution access to the faucets. As installed, the filter will remove chlorine, dirt, and other matter. The filter will also eliminate most phenol (or similar) odors and tastes while delivering sparkling, taste-free water for drinking and cooking.

The water filter is located in the sanitation compartment on the outside of the motorhome. The water filter is not guaranteed to remove the tastes and odors of iron and sulfur. To remove these impurities, you need to chlorinate the water. Replacement filters are available that will filter iron and sulfur. Ask your dealer or RV supply center about purchasing an iron and sulfur filter.

If you are traveling in an area where the water has high iron and sulfur content, add one tablespoon of chlorine bleach to every 10 gallons of water in your tank—this will precipitate the iron or sulfur so that the filter can remove those impurities.

If you are at a site where the unit is connected to a city water supply, you will not be able to chlorinate the system because the water flows straight to your faucets and not through the freshwater tank.

Filters must be changed every 6-12 months depending on the quality and quantity of water that is used in your motorhome.

SANITIZING

To ensure complete disinfecting of the freshwater system, Tiffin Motorhomes recommends that the following procedures be performed on a new system, on one that has not been used for a length of time, or one that might have become contaminated. This procedure is also recommended before long periods of storage, such as during the winter months:

Drain the freshwater tank by opening the drain valve. All of the faucets should be in the closed or OFF position.

Prepare a chlorine solution using one gallon of water and one-half cup of chlorine bleach (5% sodium-hypochlorite solution). Prepare enough of the chlorine solution to administer one gallon of solution for every 15 gallons of tank capacity. For sanitizing this unit, prepare 4½ gallons of the chlorine solution. This mixture puts a 50 ppm (parts per million) residual chlorine concentration in the water system that will act as a quick-kill dosage for harmful bacteria, viruses, and slime-forming organisms. Concentrations greater than 50 ppm might damage the water lines and/or the tank.

Once the freshwater tank is empty, close the drain valves in the water tank.

Pump the chlorine solution into the tank by taking the hose attachment and attaching it to the pump and then put in the chlorine solution. Close the valve from the fresh water tank to the pump and

PLUMBING & BATH FEATURES

open the valve from the solution to the pump. Turn the tank fill valve from “city water” to “tank fill.” Turn ON the water pump until all of the solution is pumped into the fresh water tank.

Turn OFF the water pump. Open the valve from the tank to the water pump. Fill the water tank with the city water tank fill (or by using the same method as was used to put the sanitizing solution into the tank). Remove the water filter (from the drink dispenser faucet, if installed). Open each faucet, in turn, including the kitchen faucet, bath faucet, and inside and outside showers, turning ON both the hot and cold faucets and flushing the toilet until all of the air has been purged from the pipes and the water runs freely. The entire system will then be filled with the sanitizing solution.

Allow the 50-ppm disinfecting solution to stand in the system for at least four hours.

Drain the system and flush it with freshwater. The water system needs to be flushed with water repeatedly, if necessary, until there is no chlorine taste or smell left in the system. To remove any excessive chlorine taste or odor that might remain, prepare a solution of one quart of vinegar to five gallons of water. “Rock” the tank containing the solution by moving the vehicle forward and backward several times to clean the tank; then, drain that tank and refill with clean water.

WATER HEATER BYPASS SYSTEM

The water heater bypass valve (Figure 0-9) is located in the outside utility compartment. This process is performed when winterizing your motorhome. Using the bypass valve will keep antifreeze out of the water heater when winterizing the motorhome.

Draining the water heater during winterizing is a **MUST**.



Figure 0-9: Water Heater Bypass System

FRESHWATER LINES

Check all of the plumbing connections for leaks at least on an annual basis.

If the water pump runs when all faucets are turned OFF, check for a possible leak. Be sure that the drain valves are closed. Connections at the kitchen and bathroom faucets normally seal by hand tightening them and then making an additional half-turn with a wrench.

If a fitting leak persists, disconnect it completely and visually inspect it for mineral deposits or foreign material stuck on the sealing surfaces. Clean the surfaces thoroughly and reinstall the fitting. Take the motorhome to an authorized Tiffin Motorhomes service center for additional repairs if the water system continues to leak.

Follow the winterizing instructions given in Chapter 0 to reduce risk of leaks caused by cracks from freezing pipes. Left unchecked, freezing damage can be extensive and expensive.

PLUMBING & BATH FEATURES

WASTEWATER SYSTEM

WASTEWATER GENERAL INFORMATION

The waste drainage system was designed to provide adequate and safe storage and/or disposal of waste materials. All of the materials used in the fabrication of this system are tested by a nationally recognized testing laboratory. The drainage system uses plastic piping and fittings connected to the sinks, toilet, and holding tanks.

This plumbing permits the drainage of these fixtures to an outside termination. The vehicle should be reasonably level for best operation of both of the wastewater systems.

There are two, separate wastewater systems. The gray-water system is for wastewater from the sinks and shower. The black-water system is for sewage waste from the toilet. Each wastewater tank has its own control valve and both drain through a common sewer-drain hose.

TOILET

The toilet (Figure 0-10) operates with water from either the fresh water tank with the water pump ON or the city water supply. Before using the toilet, add water to the bottom of the tank. Refer to the “Black-Water Holding Tank” instructions.

The toilet flushes waste directly into the black-water holding tank.

Your unit is equipped with a Waste Water Elimination system. Please refer to the manufacture owner’s manual for proper operation.



Figure 0-10: Toilet Pedal Flush Lever

NOTICE

It is important that you use as much water as possible when flushing to prevent tissue and other solids from clogging the holding tank outlet.

When using your toilet, fill the toilet $\frac{3}{4}$ full of water. To add water to the toilet bowl, push the pedal lever $\frac{1}{4}$ of the way down to fill the bowl to the desired water level. To flush the toilet, push down on the lever until the water swirls. A small amount of water should remain in the bowl.

The toilet must be cleaned regularly for maximum sanitation and operational efficiency. Clean the toilet bowl with a mild bathroom cleaner.

PLUMBING & BATH FEATURES

NOTICE

Do not use chlorine or caustic chemicals, such as bleach or drain opening chemicals in your motorhome's toilet. This will damage the seals in the toilet and dump valves.

BLACK-WATER HOLDING TANK

The “black-water” (i.e., sewage) holding tank is located directly beneath the toilet. Before using the toilet, you will need to treat the tank with water that is mixed with an odor-controlling chemical. These chemicals are readily available at any RV supply store. Pull the toilet levers forward to allow the chemicals to mix with the toilet water. Continue pulling the toilet levers until a depth of at least one inch of solution is directly under the toilet. Release the levers. The waste tank is now ready for use.

GRAY-WATER HOLDING TANK

The gray-water holding tank is located in the underbelly of the vehicle. It is primarily used for the drainage from the kitchen and bath sinks, and the shower.

P-TRAPS

Each of the sink drains and the shower drain has a water trap (P-trap) to prevent holding-tank odors from entering the vehicle.

These traps must have water in them to trap odors. When the vehicle is in motion, the water might splash out of the sink and shower drains. When the vehicle is stored, the water might evaporate from these traps allowing odors to enter the vehicle. If this occurs, run water from the faucet into the drain, allowing water to fill the traps again.

NOTICE

Use only RV odor-controlling chemicals in the holding tanks. Products containing ammonia and petroleum will damage the ABS plastic holding tanks and seals.

PLUMBING & BATH FEATURES

WASTEWATER DISPOSAL

Both of the holding tanks terminate in a valve arrangement that permits draining each tank separately or together.

Drain the black-water tank first before draining the gray-water tank. This procedure permits the water from the gray tank to wash the black-water residue from the drain lines and hose found in the external sanitation compartment.

NOTE: The T-handles (Figure 0-11) are color coded to distinguish between the black-water holding tank and the gray-water holding tank. The black-water holding tank T-handle is black and the gray-water holding tank T-handle is gray.

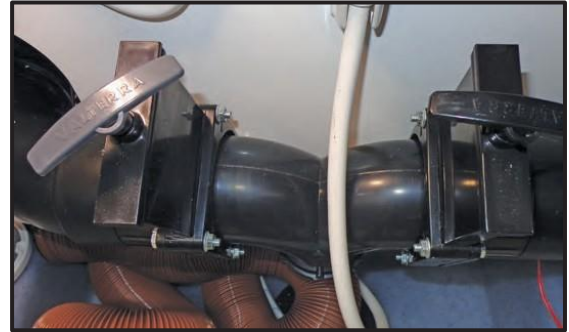

Figure 0-11: Sanitation Coupling

The valves that open to release the water are called gate valves. The blade that closed the opening in the sewer drainpipes is connected to the T-handle to release contents of the tanks when pulled. The sewer line must be securely capped during self-containment use to prevent leakage of waste materials. Do not pull the holding tank gate valve OPEN when the protective cap is installed on the pipe.

Always drain the tank into an acceptable sewer inlet or dump station. Whenever possible, drain both the holding tanks before traveling. The carrying capacity of your vehicle will be reduced if water is left in the black or gray tanks. The holding tanks must be drained only when they are at least $\frac{3}{4}$ full. Doing this will provide a sufficient volume of water to allow the complete flushing of waste materials in the drain lines and hose. If the tanks are not $\frac{3}{4}$ full, add enough water to allow for sufficient flushing.

To empty the wastewater tanks, connect the adapter supplied with your vehicle to the drain hose (Figure 0-11). One end of the hose threads up through the hole in the bottom of the service compartment and the other end of the hose feeds into the sewer at the dump station.

Unscrew the cap from the drain. Connect the hose, with the adapter in place, to the drain fitting. Open the gate valve completely by pulling on the T-handle. The tank will start to drain as soon as the T-handle is pulled. After you have drained the black-water tank, immediately drain the gray-water tank. This procedure helps to flush the black water from the sewage hose.

When both the tanks are empty, flush them with a freshwater rinse before you close the valves. The gray tanks are flushed by pouring a couple of gallons of water into a sink drain. The drain outlet is engineered for quick release of the drain hose adapter. Always close the gate valves and secure the end cap to prevent leakage while the vehicle is in transit.

After draining the black-water tank, add a holding-tank deodorant to help control the odor and break down the solids. Follow the instructions given on the holding-tank deodorant package.

SEWER CONNECTION AND CAMPING

While using the motorhome, it is important to keep the black-water holding tank gate valve closed at all times, except when dumping. This allows an ample amount of liquid to remain in the tank to provide a smooth flow through the gate and the drain valves when dumping.

PLUMBING & BATH FEATURES

Sufficient liquid in the tank causes a swirling action that takes any accumulated solid wastes with it. Accumulation of solid wastes in the black-water tank can be avoided by keeping the gate valve closed when connected to the sewer connection. The gray tank can be kept open while hooked to a sewer connection.

NOTE: Dump the black-water tank first, then the gray-water tank.

NO FUSS FLUSH



Figure 0-12: Tank Flush Connection

This vehicle is equipped with a flushing system for the black-water holding tank. When draining your sewer tank, attach a water hose to the tank flush connection. After the tank is drained, leave the gate valve “open” and open the water valve to allow the water to spray inside the black-water tank. This will clean the inside of the tank of any debris that might be left inside the tank. After this procedure is done, disconnect the freshwater hose and close the gate valve.

NOTICE

Be sure the gate valve is OPEN when flushing the tank. Do not use the same hose that is used for filling the fresh water tank for the No Fuss Flush.

EXTERIOR SHOWER

Your motorhome has an exterior shower (Figure 0-13) for your use and convenience outside the motorhome.

The exterior shower is located in the service compartment on the driver’s side and enables you to do such things as rinse off sand or grass, muddy shoes, or bathe yourself outside of your motorhome.

The faucet operates just as it would in your kitchen or bathroom.

There is also a soap dispenser and light conveniently located in the compartment.



Figure 0-13: Exterior Shower and Shower Light

PLUMBING & BATH FEATURES

PLUMBING DIAGRAM

33AL

Water Line Layout

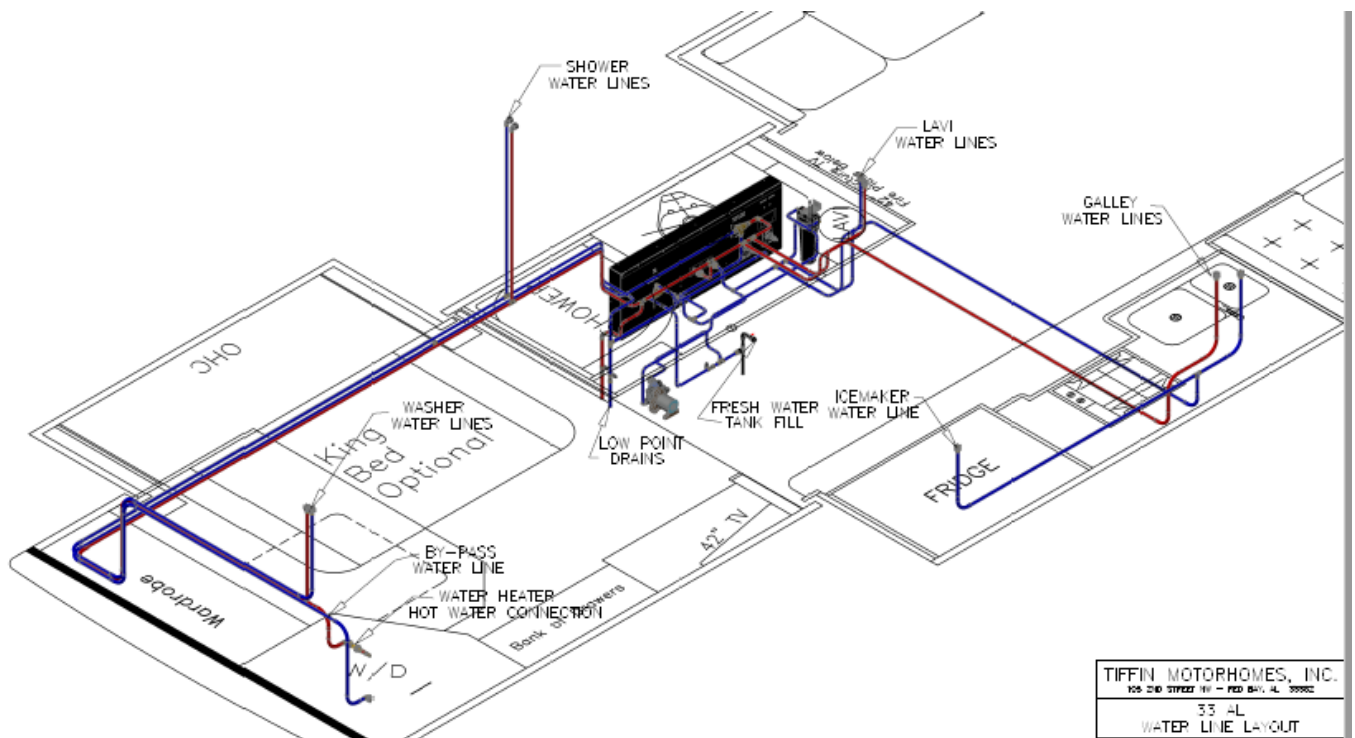

Fresh Water Fill/Pump Out

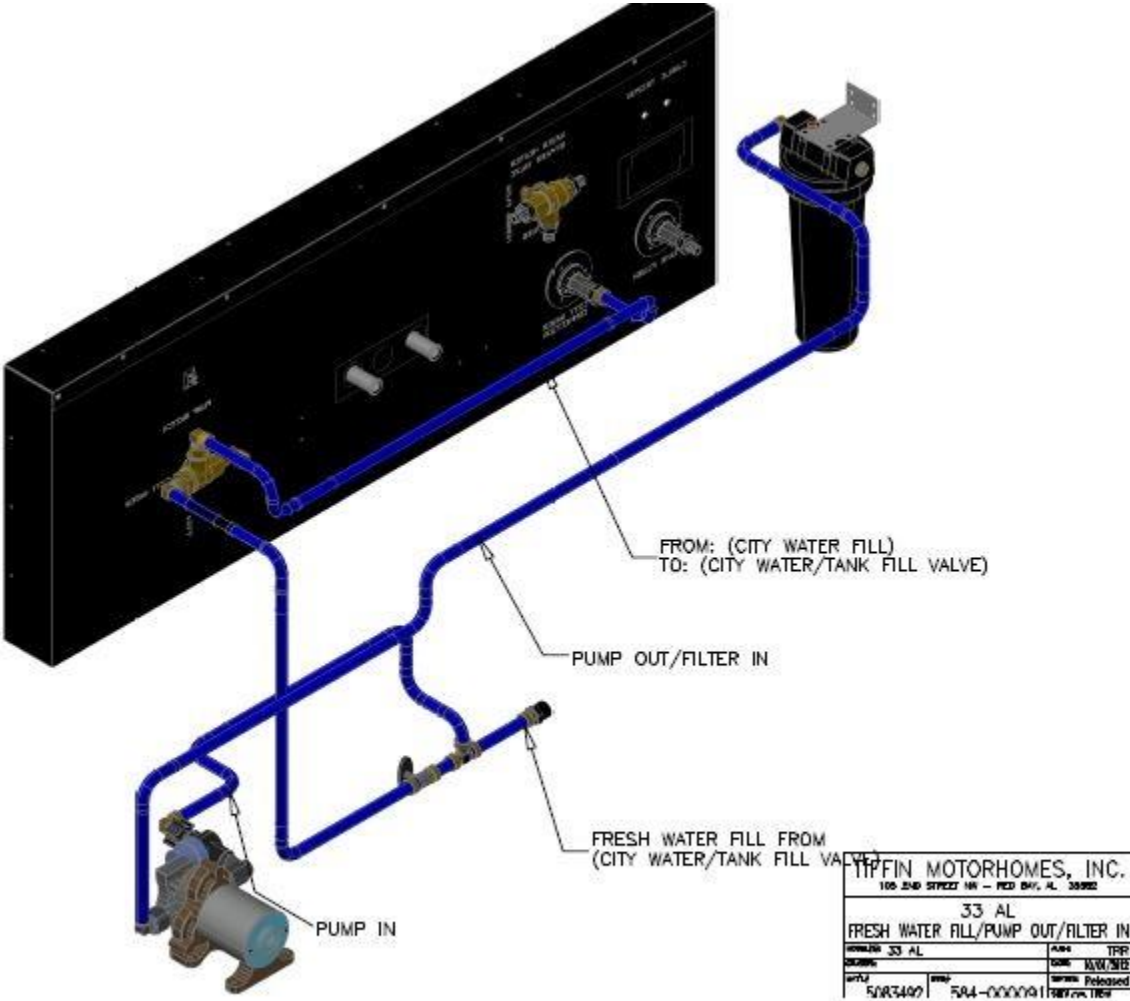



**WINDOWS, AWNINGS,
VENTS, & DOORS**

Chapter

14

WINDOWS, AWNINGS, VENTS & DOORS

WINDOWS

Sliding windows (Figure 0-1) are custom built for the motorhome and allow easy sliding access to open the coach to fresh outside air.

There might also be a reflective coating on the windows to reflect back a portion of the sunlight to reduce the heating of the motorhome interior and to reduce the effects of the sun's "bleaching" of interior fabrics (curtains, upholstery).

Sun shades on both the driver's and passenger's sides can be deployed and moved at any time.

Windows throughout the coach are designated as "EXIT" windows in the event of an emergency.

To help make the windows slide more easily, Tiffin Motorhomes recommends using Plexus Plastic Cleaner, which can be purchased through the Tiffin Motorhomes Service Department.



Figure 0-1: Motorhome Windows

AWNINGS



Figure 0-2: Power Patio Awning

The power patio awning (Figure 0-2) is standard on the BYWAY.

The power patio awning is extremely durable and can be operated during light rain and wind conditions. However, **when periods of heavy rain, or wind is expected, or you leave the awning unattended, the awning should be closed. Note that damage caused by wind and rain is not covered by warranty.**

To operate the awning, follow the instructions listed below.

To open the awning:

Locate the Remote Switch in the overhead cabinet above driver's seat.

Press and release the EXTEND button and the awning will automatically open.

To close the awning:

Locate the Remote Switch in the overhead cabinet above driver's seat.

Press and release the RETRACT button to automatically close the awning.

WINDOWS, AWNINGS, VENTS & DOORS

IMPORTANT: As an extra safety precaution, visually verify that the awning is fully closed.

In case of awning power failure or to manually close the awning:

**WARNING**

Pinch Hazard. When closing the awning, lead rail will nest against back channel. This area must be kept clear of people and objects. Failure to heed this warning could cause severe personal injury and/or property damage.

1. The Girard GG750 has a manual override to close the awning in case of power failures.
2. Remove the endcap opposite the motor, by removing the 3 Philips head screws.
3. Using a 13mm wrench, turn the square manual override shaft in order to close the awning, see Figure below. **NOTE:** The manual override is one-way, it can only be used to close the awning.
4. Replace endcap using the 3 Philips head screws.
5. Figure below is showing a right hand motor version of the GG750. If your coach is equipped with a left hand version, the manual override will be on the opposite side.
6. Once power is restored, the awning will resume normal operation.

NOTE: This procedure can also be used to manually retract the Over the Door Awning.

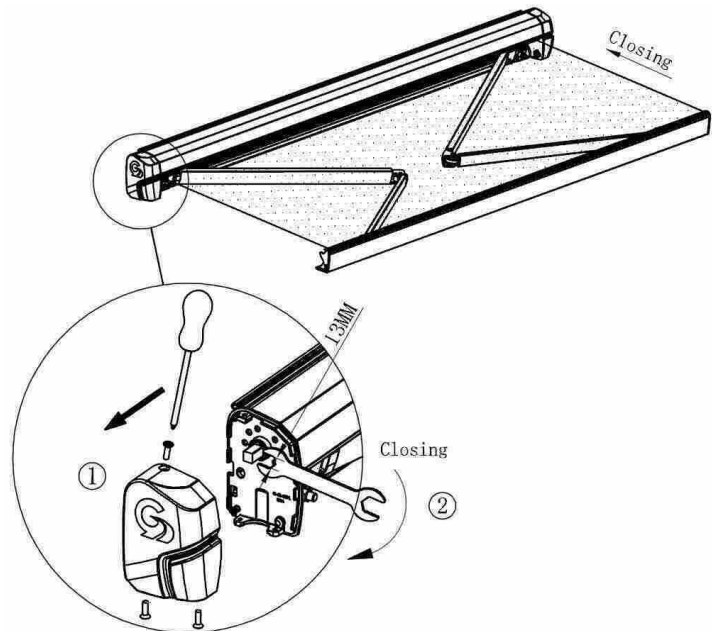

WINDOWS, AWNINGS, VENTS & DOORS

Connect the user-supplied wire leads to the terminals in the connector from the motor. Electrical tape might be required to keep the wire leads in place. (Do not connect to the one in the hardware).

Connect the other end to a 12 VDC battery source. The red wire goes to + and the black to -. If there is not a problem with the awning motor, this will retract the awning. To avoid motor damage, disconnect the battery source immediately after the awning is fully retracted.

The awning can be extended by reversing the polarity. Place the red wire on the - and the black wire on the +. Disconnect the battery source after the awning is fully extended.

If the awning will not retract after performing the steps listed above, perform the following steps:

Slide the pull strap (provided) into the utility slot of the FRTA (see awning instructions found in the Owner's Information Package, page 4, Figure 6).

While one person is holding onto the pull strap, remove the screw in the top of the right top casting. The FRTA will immediately roll in once the bolt is removed. Walk the awning to the closed position.

Align the hole where the screw was removed and replace the screw into the top casting to secure the awning.



WARNING

In case of power issues, the GG750 has a manual override to close the awning. Remove the endcap opposite the motor, by removing the 3 Philips head screws.
3. Using a 13mm wrench, turn the manual override shaft in order to close the awning, see Figure 10. NOTE: The manual override is one-way, it can only close the awning.
4. Figure 10 is showing a right hand motor version of the GG750. If you have a left hand version, the manual override will be on the opposite side.



WARNING

Since damage resulting from weather is not under warranty, anytime a heavy or prolonged rain or blustery winds are anticipated, close the awning. Similarly, if the awning is to be left unattended for any prolonged length of time, close the awning.

NOTE: The screw removed from top of right casting has to be reinstalled. This is to prevent the awning from opening during travel; personal injury or damage can occur. Have the awning serviced by a Dometic Service Center or a qualified service technician before attempting to open the awning after this procedure has been performed.

WINDOWS, AWNINGS, VENTS & DOORS

VENTS

The kitchen and bathroom are both equipped with a 12 VDC exhaust vent (Figure 0-3). The fans are controlled by the fan tab on the Spyder Controls System (Figure 0-4). A three-speed switch on each vent fan controls the fan speed.



Figure 0-3: Overhead Vent Fan



Figure 0-4: Vent/Fan Controls

IMPORTANT: The vent fan must be left in the ON mode only when the motorhome is parked and in use. The fan will not operate until the vent is open.

DOORS

The primary entrance door to the motorhome has a key lock and a dead bolt for additional security. When the door is fully opened, the door hinge automatically holds the door in an OPEN position.

There is also a screen that allows increased air circulation when the entrance door is open.





DRIVING YOUR MOTORHOME

Chapter

15

ECOMASTER CAMERA SYSTEM



Figure 0-1: Rear View Camera Monitor System

The rear view monitoring system (Figure 0-1) is provided to aid the driver in backing and parking the motorhome.

A camera mounted on the rear of the vehicle feeds a televised view of the rear of the motorhome to the monitor located in the front near the driver.

If the switch is in the MANUAL mode, the monitor will be ON when the ignition switch is turned ON.

If the switch is in the AUTOMATIC mode, the monitor will display the picture from the rear-mounted camera only when the transmission is in REVERSE gear.

To use this system effectively, refer to the owner's manual for this system. This manual is in the Owner's Information Package.

BASIC REAR VIEW CAMERA OPERATION

Depress the POWER switch. The picture appears on the monitor. POWER indicator lights up green. To turn off the picture, press it again to release. The monitor moves to standby condition. POWER indicator lights up red.

Adjust the VOLUME control.

Adjust the picture contrast and brightness. The DAY/NIGHT selector switch must normally be kept in the DAY (released) position. When you view the picture at night or in a tunnel, etc., depress the switch to make the picture less bright (therefore in the NIGHT position). Thus, the picture will be easy to view even in a dark place.

When you set the gear level to the "R" position with the POWER switch released, the monitor is turned ON, and the picture from the camera connected to the CAMERA "A" connector appears irrespective of the INPUT knob setting.

ROADWATCH

Your RED340 is equipped with a RoadWatch. This system combines stability control and collision mitigation with a dynamic cruise control system. We encourage you to learn more about each of the components from the chassis manufacturer's operation manual included in this binder.

SIDE-MOUNT CAMERA



Figure 0-2: Side-Mount Camera Monitor

As an enhanced aid to driving, the motorhome features side-mounted cameras (Figure 0-2) on both sides of the motorhome.

These side-mounted cameras are activated whenever the motorhome in transit begins to make a turn. When the LEFT turn indicator is used, the left-side camera is activated and that camera displays on the back-up monitor a rearward-oriented view of the driver's side showing that side of the motorhome and a limited panorama of what is alongside and immediately behind the motorhome as it begins to turn into that direction.

In this manner, the typical "blind spot" of most motorhomes is drastically reduced or eliminated so that the driver can make those turns with great confidence. Similarly, the "right" turn indicator operates in the same manner to show a rearward view of the right side of the motorhome when a right-hand turn is made.

CB RADIO SYSTEM ANTENNA CONNECTION

As an option, the motorhome might come equipped with an antenna and coaxial cable connection to enable the owner to install a Citizens Band (CB) radio of choice, and operate it conveniently from the motorhome.

The coaxial-cable connection for the radio is found beneath the dashboard on the driver's side. Accordingly, with an owner-provided CB radio, that radio can be used to communicate with other travelers on the road.

To use your CB system of choice, follow the directions furnished with the CB radio.

NOTE: Channel 11 is considered an emergency channel and monitoring this channel might give one information about road conditions, accidents, and related matters potentially affecting your travels.

AM/FM/CD STEREO SYSTEM

An AM/FM/CD stereo system (Figure 0-3) is included in the motorhome.

This system is powered by the 12-volt DC system of the motorhome and operates like any conventional car-stereo system. The coach is also SIRIUS XM compatible with a subscription.



Figure 0-3: CD Player

DASHBOARD HEATING/COOLING CONTROLS

The dash air conditioner/heater (Figure 0-4) is not designed to heat and cool the entire interior of the motorhome. It is intended only to provide heating and cooling for the cab area.

A small amount of air will blow out of the defrost and dash vents regardless of the mode settings.



Figure 0-4: Dashboard Controls

AUTOMATIC TRANSMISSION CONTROLS

You Motorhome has a Freightliner chassis. The shifting mechanism on your BYWAY is located on the steering column.



Figure 15-8 Freightliner Transmission Controls

TIRE PRESSURE MONITORING SYSTEM

Now is the time for all good men to come to the aid of their country.

AUTOMATIC LEVELLING SYSTEM

The Valid Treeline Levelling System (Figure 15-10) is an automatic one-touch levelling system designed specifically for you RV. Valid utilizes leading-edge technology to measure along 3 separate axes (across front and rear axles, and longitudinally) of the vehicle chassis to check for both level and twist and then accurately levels the vehicle. The flexible control process is automated to ensure that operation is simplified for the end user.

Refer to the manufacturer's owner's manual to more information regarding this system.



Figure 0-10: Levelling System Control Panel



ROUTINE MAINTENANCE

Chapter

16

NOTICE

Damage caused by improperly performed maintenance or inadequate maintenance is not covered by your Tiffin Motorhomes limited warranty.

WASHING

The paint on your Tiffin motorhome has a polyurethane base called Diamont. While multiple layers of clear coat sealants protect the paint against oxidation, the sealant must be protected from deterioration (Figure 0-1).

Paint manufacturers advise against using harsh cleaners such as Simple Green, Mr. Clean, or liquid dishwashing soaps. The degreasing agents in these cleaners leave a residue on the sealant, which softens and damages the clear coat in time.

Baby shampoo provides an effective yet gentle cleaner. Without the typical heavy degreasers of most detergents, baby shampoo cleans without leaving a residue to gum up the clear coat finish. Generally, one ounce (1 oz.) is all you need per five gallon bucket of water. Add one cup of food grade distilled white vinegar to your wash bucket.

Tiffin Motorhomes recommends the lamb's wool pad sold by Mary Moppins. This enables you to safely wash your coach from the ground by placing the pad on an extension.

Do not mistake lamb's wool with imitations. Imitation pads are made from 100% polyester, which is plastic. Plastic imitations will scratch the finish of the motorhome. For this same reason, avoid microfiber products to wash or dry your motorhome. Microfiber is made from 80% polyester.



Figure 0-1: Typical Motorhome Exterior



CAUTION

DO NOT use any type of brush or plastic wash materials on the exterior paint as this could cause damage to the finish of your motorhome. Even though you might not see brush marks now, the damage will happen as the bristles wear down.

Use only 100% cotton towels to dry your vehicle. Adding vinegar to your wash water and washing in the morning or evening will help prevent water spots. Water spots damage the exterior of your coach the same way they damage glass shower doors. They etch their way into the surface and removal becomes difficult. Prevention becomes the key.

Wash one side at a time, rinse, and then dry quickly using a squeegee followed by a towel placed over the cleaning head.

To remove oil and grease, remember an important rule of cleaning: give your product time to work. Dab a bit of concentrated cleaner like CleanEz by Mary Moppins—never an orange-based cleaner or one with petroleum distillates—onto a soft cloth. Apply to the oil spot and wait for 10 to 15 minutes before rubbing lightly to remove the oil. Rinse immediately.

SEALS

The seals around the doors, windows, vents, slide-out trim and external seams must be checked at least semi-annually. Additionally, the roof seams must be inspected for cracking or peeling semi-annually. If deterioration is noted during a routine maintenance inspection, reseal the seams or seals with an approved sealant to prevent leaks.

Your Tiffin Motorhomes dealer can perform resealing inspections and subsequent work for you. Tiffin Motorhomes recommends that a Tiffin Motorhomes authorized service center perform these inspections periodically and perform necessary resealing when necessary.

PROPER SEALANTS FOR APPLICATION

The following sealants are recommended for specific sealing applications, as noted in the table. These can be purchased through the Tiffin Motorhomes parts and service department by calling 256-356-0261.

RECOMMENDED SEALANTS FOR SPECIFIC SEALING APPLICATIONS	
SEALANT	APPLICATION
Plas-T-Code	Metal or fiberglass roof
Surebond #SB-140	Rubber laminated to metal roof and ALL SKYLIGHTS
Carlisle #502-LSW self leveling sealant	Rubber roof over wood base
Silicone sealant	To cover butyl and other sealants; not to be used as the main sealant
Parbond	To seal across tops of windows on exterior surfaces where silicone is not used

NOTICE

Do not use solvents such as acetone, MEK, toluene, and the like on the decals. Any solvent including alcohol might soften and smear colors. Do not use lacquer thinner or paint thinner on decals. Do not overcoat the decals with clear paint. Do not allow gasoline or other fuels to come into prolonged contact with the decals. However, if this should occur, immediately flush the affected area with water.

WHEEL CARE

The care and maintenance of your wheels are simple and require no special material or products; follow the directions included in the Owner's Information Package for these. Timely care and cleaning will maintain the appearance of these wheel products for many years.

Be sure to completely wash the aluminum wheels free of all road treatment salt or other chemicals, paying close attention to the area behind the decorative lug nut covers.



CAUTION

Do not use harsh detergents, acids, or abrasives, which might scratch or dull the surfaces. The applicator cloth, sponge, or soft-bristled brush must be non-metallic and non-abrasive. Also, remember to check the tightness of the wheel lug nuts frequently.

ROOF CARE & MAINTENANCE

Proper care and maintenance of your motorhome, including your roof, is important for sustained, trouble-free performance. Normal maintenance is simple and easy and does not require special materials.

The roof of the motorhome is fiberglass and can be cared for in the conventional manner. Clean the roof at least every three months. The roof must be professionally inspected by a dealer annually.



WARNING

Use caution when working on the top of your motorhome. The wet roof might be extremely slippery and, as such, a possible safety hazard.

MOISTURE MANAGEMENT

This section outlines important recommendations to manage moisture in your motorhome to avoid moisture-related damage, such as mold. The materials and methods used to construct your motorhome were selected in part to minimize air leakage and to create a weather-tight exterior shell. However, in order to protect your investment, and reduce the risk of moisture-related damage and costly repairs, attention and care has to be taken to manage moisture inside your RV.

NOTE: These are only suggestions intended to minimize moisture-related issues with your motorhome. If any concerns arise, contact Tiffin Motorhomes' Service Department at (256) 356-0261.

INTERIOR CARE OF YOUR RV

Signs of excessive moisture can be obvious, such as water droplets forming on surfaces or wet carpet. Conversely, signs of excess moisture can be subtle, such as condensation forming on metal surfaces. When symptoms appear, it is important to immediately determine the cause of the excess moisture and take appropriate corrective action to prevent moisture-related damage.

CONTROL RELATIVE HUMIDITY

Monitoring and controlling relative humidity within the motorhome is one of the most important steps to minimize the risk for moisture-related damage. Ideally, relative humidity should be at 60% or less. Relative humidity can be monitored utilizing a portable hygrometer, which is a small device that measures temperature and relative humidity.

Use exhaust fans, the air conditioner, and/or a portable dehumidifier to manage moisture inside the RV to maintain relative humidity at 60% or less. In cold climates, relative humidity might need to be at 35% or less to avoid window condensation issues. If the motorhome is used, the majority of the time in a hot, humid climate, it might be difficult to keep relative humidity below 60%. A dehumidifier will help, but check the condensation (water) collection bucket regularly or discharge the condensation (water) directly to a drain.

AVOID DRASTIC THERMOSTAT SETBACKS

To minimize the opportunity for condensation to form on interior surfaces, maintain a comfortable temperature in your RV, and avoid nighttime setbacks of 10 degrees or more. Drastic setbacks that reduce the indoor air temperature quickly can increase the chance for airborne moisture to condense on cool surfaces such as windows. If you are away from your RV for an extended number of days, do not

set the temperature back without taking other measures to manage relative humidity, including operating a dehumidifier with a continuous drain.

MANAGE WINDOW CONDENSATION

Window condensation issues can be identified by water or ice build-up, usually at the base of the window. The majority of these problems can be addressed by managing moisture generated inside the motorhome. Minor condensation issues are not unusual, especially for RVs used in colder climates. To help minimize window condensation, use exhaust fans vented to the outside, avoid drastic changes in thermostat settings, do not use “vent-free” heaters, and use window coverings wisely. For example, make sure to open curtains or blinds during the day to allow air to circulate and warm the window surface.

CARPET CARE AND MOISTURE MANAGEMENT

The carpet must be cleaned when it shows signs of discoloration or traffic patterns. A steam cleaning system must be used to clean the carpet unless otherwise noted in your warranty information. To manage moisture from the cleaning process, the cleaning system needs to be capable of extracting the excess water from the carpet after it has been cleaned.

IMPORTANT: Be sure the carpet is thoroughly dry before closing up the RV for storage. Water from the cleaning process can cause significant damage to the RV if the carpet is not completely dry before closing up the motorhome for an extended period.

CLEANING TILE AND WOOD FLOORS

Most floors only require a mild detergent and warm water for cleaning. More water on the floor is not always better for cleaning. Use a damp cloth to clean on a regular basis rather than wet mopping each time.

STORAGE AND OTHER ISOLATED AREAS WITHIN THE RV

Storage areas are more difficult to condition since the areas are isolated from the main body of the RV. The surfaces of these areas are more at risk for condensation and surface mold growth. To minimize this risk, clean storage areas regularly, and allow an air space between stored items and the exterior wall to promote air circulation.

USE OF UN-VENTED COMBUSTION EQUIPMENT

Un-vented combustion equipment, such as propane stovetops are a source of moisture within the RV. For every gallon of fuel consumed, approximately one gallon of water vapor is evaporated into the air. Whenever possible, operate an exhaust fan in combination with the use of any un-vented combustion appliance within the RV. Water vapor and other combustion by-products must be vented to the exterior of the RV. The RV owner must strictly follow use and maintenance instructions for safe operation of any combustion equipment, particularly un-vented equipment.

EXTERIOR CARE OF YOUR RV

The exterior shell of the RV is the primary weather and moisture barrier. Over the life of the vehicle, the shell will require regular care and maintenance in accordance with other instructions for exterior care. The shell includes the roof, sidewalls, windows, doors, and under-floor of the vehicle. Particular attention needs to be devoted to ensure these components are maintained to ensure a tight barrier against bulk water intrusion. The shell must be inspected periodically for tears, gaps, and condition of sealants in accordance with this owner's manual. Areas that require maintenance must be resealed using a similar, high-quality sealant used by the manufacturer. Particular attention must be devoted to ensure the slide outs are functioning properly. Each time a slide out is used, it must be inspected to ensure proper operation and sealing. The slide out gaskets must also be inspected to ensure proper sealing when the slide out is operated.

USE OF YOUR RV

The square footage of an RV is significantly less than that of a single-family residence. This fact alone will elevate the relative humidity because there is less volume of air to help absorb or dissipate the humidity. For example, showering and cooking create a lot of humidity in a small area. In these instances, use of an exhaust fan and opening windows should reduce the relative humidity, particularly when living in the RV for an extended period.

SEVERE ENVIRONMENTS

Prolonged use of your RV in severe environments—for example in extremely cold or hot-humid climates, will require extra care and maintenance to avoid moisture-related issues. In both extremely cold and hot humid climates, more attention needs to be focused on controlling the relative humidity within the RV. It also might require the use of a portable dehumidifier to manage the relative humidity within an acceptable range.

STORAGE OF YOUR RV

During periods when your motorhome is not in use, care must be taken to ensure that moisture sources are addressed. Ideal storage of your RV would be in an enclosed, climate-controlled environment. When this is not possible, the following steps must be taken to ensure moisture is controlled:

- Turn off all water sources.
- Turn off all combustion appliances.
- Drain the water tanks.
- Drain the water heater.
- Open all closets, cabinet doors, and drawers.
- Close all windows and entrance doors.
- Open a vent or a window enough to allow for some limited ventilation airflow, but not so far as to allow snow or rain to enter.
- When storing the RV in high humidity climates, add a dehumidifier drained to exterior to control humidity inside the RV during storage.

- Refer to other sections of this owner’s manual for additional recommendations.

MODIFICATIONS TO YOUR RV

Consult Tiffin Motorhomes for guidance before making any modifications to your RV. It is important that changes be completed by a qualified service firm to ensure that moisture intrusion or accumulation problems do not occur.

WET AREAS

Areas that are exposed to water spills or leaks must be dried as soon as possible and definitely within 24 to 48 hours. Drying areas quickly minimizes the chance for moisture damage and possible mold growth, which can begin to form colonies within 48 hours. A variety of methods can be used to help the drying process:

- Remove excess water with an extraction vacuum.
- Use a dehumidifier to aid drying.
- Use portable fans to move air across the surface.
- Because moisture is key to mold issues, treat all signs of condensation and spills seriously and deal with promptly. Failure to deal with a moisture issue promptly might cause more severe issues where none initially existed, or might make a small problem much worse.
- Learn to recognize signs of mold—do not paint over or cover up suspicious discoloration until you are sure it is not mold. The affected surface must first be cleaned and dried; residual staining may be painted.
- Be sure to understand and eliminate the source of moisture accumulation as a part of the clean up. Otherwise, the same issues will reoccur.
- Small amounts of mold must be cleaned as soon as it appears. Small areas of mold must be cleaned using a detergent/soapy solution or an appropriate RV household cleaner. Gloves must be worn during cleaning. The cleaned area must then be thoroughly dried. Dispose of any sponges or rags used to clean the mold.

TIRE & SAFETY INFORMATION

This portion of the Owner’s Manual contains tire safety information as required by 49 CFR 575.6. The National Traffic Safety Administration (NHTSA) can be contacted at 1-888-327-4236. Their website is <http://www.safercar.gov> and their address is NHTSA, 400 Seventh St, S.W., Washington, D.C. 20590.

SECTION ONE

The National Traffic Safety (NHTSA) has published a brochure (DOT HS 809 361) that discusses all aspects of Tire Safety, as required by CFR 575.6. This brochure is reproduced in part below. It can be obtained and downloaded from NHTSA, free of charge, from the following website: <https://one.nhtsa.gov/cars/rules/TireSafety/ridesanit/brochure.html>

Studies of tire safety show that maintaining proper tire pressure, observing tire and vehicle load limits, avoiding road hazards, and inspecting tires for cuts, slashes, and other irregularities are the most important things you can do to avoid tire failure, such as tread separation or blowout, and flat tires.

These actions, along with other care and maintenance activities, can also:

- Improve vehicle handling.
- Help protect you and others from avoidable breakdowns and accidents.
- Improve fuel economy.
- Increase the life of your tires.

This section presents a comprehensive overview of tire safety, including information on the following topics:

- Basic tire maintenance.
- Uniform Tire Quality Grading System.
- Fundamental characteristics of tires.
- Tire safety tips.

Use this information to make tire safety a regular part of your vehicle maintenance routine. Recognize that the time you spend is minimal compared with the inconvenience and safety consequences of a flat tire or other tire failure.

Safety First-Basic Tire Maintenance

Properly maintained tires improve the steering, stopping, traction, and load-carrying capability of your vehicle. Under-inflated tires and overloaded vehicles are a major cause of tire failure. Therefore, as mentioned above, to avoid flat tires and other types of tire failure, you must maintain proper tire pressure, observe tire and vehicle load limits, avoid road hazards, and regularly inspect your tires.

Finding Your Vehicle's Recommended Tire Pressure and Load Limits

Tire information placards and vehicle certification labels contain information on tires and load limits. These labels indicate the vehicle manufacturer's information including:

- Recommended tire size.
- Recommended tire inflation pressure.
- Vehicle capacity weight (VCW—the maximum occupant and cargo weight a vehicle is designed to carry).
- Front and rear gross axle weight ratings (GAWR—the maximum weight the axle systems are designed to carry).

For motorhomes: Both placards and certification labels are on a sticker that is located in the rear closet.

Understanding Tire Pressure and Load Limits

Tire inflation pressure is the level of air in the tire that provides it with load-carrying capacity and affects the overall performance of the vehicle. The tire inflation pressure is a number that indicates the amount of air pressure—measured in pounds per square inch (psi)—a tire requires to be properly inflated. (You will also find this number on the vehicle information placard expressed in kilopascals (kPa), which is the metric measure used internationally).

Vehicle manufacturers determine this number based on the vehicle's design load limit, that is, the greatest amount of weight a vehicle can safely carry, and the vehicle's tire size. The proper tire pressure for your vehicle is referred to as the "recommended cold-inflation pressure."

Because tires are designed to be used on more than one type of vehicle, tire manufacturers list the "maximum permissible inflation pressure" on the tire sidewall. This number is the greatest amount of air pressure that can ever be put in the tire under normal driving conditions.

Checking Tire Pressure

It is important to check your vehicle's tire pressure at least once a month for the following reasons:

- Most tires naturally lose air over time.
- Tires can lose air suddenly if you drive over a pothole or other object, or if you strike the curb when parking.
- With radial tires, it is usually not possible to determine under-inflation by visual inspection.

For convenience, purchase a tire pressure gauge to keep in your vehicle. Gauges can be purchased at tire dealerships, auto supply stores, and other retail outlets.

The recommended tire inflation pressure that vehicle manufacturers provide reflects the proper psi when a tire is cold. The term cold does not relate to the outside temperature. Rather, a cold tire is one that has not been driven on for at least three hours. When you drive, your tires get warmer, causing the air pressure within them to increase. Therefore, to get an accurate tire pressure reading, you must measure tire pressure when the tires are cold or compensate for the extra pressure in warm tires.

Steps for Maintaining Proper Tire Pressure

Locate the recommended tire pressure on the vehicle's tire information placard, certification label, or in the owner's manual.

Record the tire pressure of all tires.

If the tire pressure is too high in any of the tires, slowly release air by gently pressing on the tire valve stem with the edge of your tire gauge until you get to the correct pressure.

If the tire pressure is too low, note the difference between the measured tire pressure and correct tire pressure. These "missing" pounds of pressure are what you will need to add.

At a service station, add the missing pounds of air pressure to each tire that is under-inflated.

Check all the tires to make sure they have the same air pressure (except in cases in which the front and rear tires are supposed to have different amounts of pressure).

If you have been driving your vehicle and think that a tire is under-inflated, fill it to the recommended cold-inflation pressure indicated on your vehicle's tire information placard or certification label.

While your tire might still be slightly under-inflated due to the extra pounds of pressure in the warm tire, it is safer to drive with air pressure that is slightly lower than the vehicle manufacturer's recommended cold-inflation pressure than to drive with a significantly under-inflated tire. Since this is a temporary fix, do not forget to recheck and adjust the tire's pressure when you can obtain a cold reading.

Tire Size

To maintain tire safety, purchase new tires that are of the same size as the vehicle's original tires or another size recommended by the manufacturer. Look at the tire information placard, the owner's manual, or the sidewall of the tire you are replacing to find this information. If you have any doubt about the correct size to choose, consult with the tire dealer.

Tire Tread

The tire tread provides the gripping action and traction that prevent your vehicle from slipping or sliding, especially when the road is wet or icy. In general, tires are not safe and must be replaced when the tread is worn down to 1/16 of an inch. Tires have built-in tread-wear indicators that let you know when it is time to replace your tires. These indicators are raised sections spaced intermittently in the bottom of the tread grooves. When they appear "even" with the outside of the tread, it is time to replace your tires.

Another method for checking tread depth is to place a penny in the tread with Lincoln's head upside down and facing you. If you can see the top of Lincoln's head, you are ready for new tires.

Tire Balance and Wheel Alignment

To avoid vibration or shaking of the vehicle when a tire rotates, the tire must be properly balanced. This balance is achieved by positioning weights on the wheel to counterbalance heavy spots on the wheel-and-tire assembly. A wheel alignment adjusts the angles of the wheels so that they are positioned correctly relative to the vehicle's frame. This adjustment maximizes the life of your tires. These adjustments require special equipment and must be performed by a qualified technician.

Tire Rotation

Rotating tires from front to back and from side-to-side can reduce irregular wear (for vehicles that have tires that are all of the same size). Look in your owner's manual for information on how frequently the tires on your vehicle must be rotated and the best pattern for rotation.

Tire Repair

The proper repair of a punctured tire requires a plug for the hole and a patch for the area inside the tire that surrounds the puncture hole. Punctures through the tread can be repaired if they are not too large, but punctures to the sidewall must not be repaired. Tires must be removed from the rim to be properly inspected before being plugged and patched.

A Tire Rotation Example

For maximum mileage, rotate your tires every 5,000 miles. Follow correct rotation patterns.

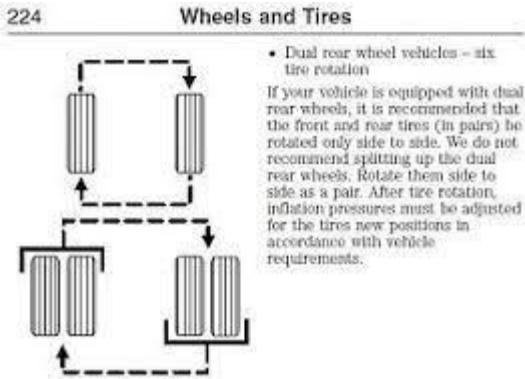
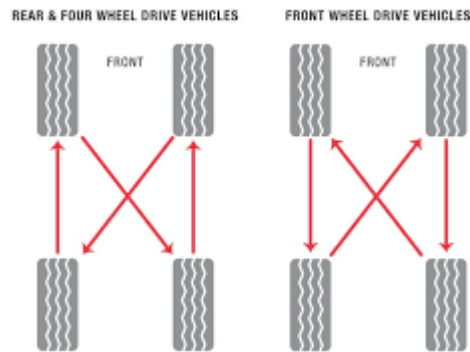
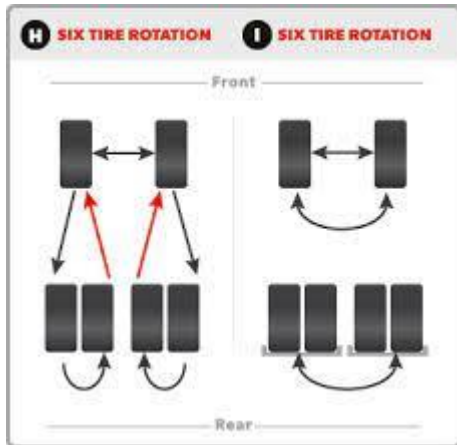
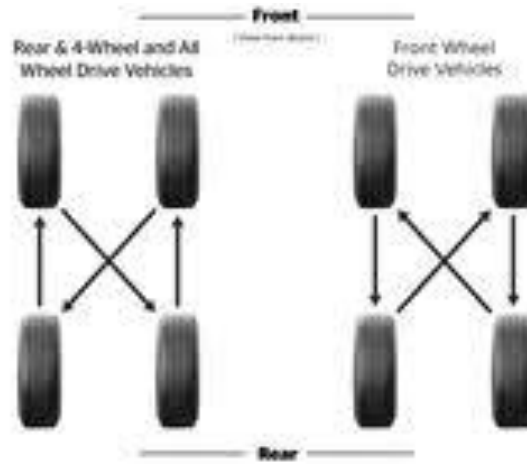

Figure 0-2: Tire Rotation



Information on Passenger Vehicle Tires

P—The “P” indicates the tire is for passenger vehicles.

NOTE: Passenger car tires are not recommended for use on trailers, because the capacity ratings are not marked on the sidewalls of these tires. In the event that a passenger car tire is used, the capacity must be de-rated by 10%.

Next number—This three-digit number gives the width in millimeters of the tire from sidewall edge to sidewall edge. In general, the larger the number, the wider the tire.

TIRE SIDEWALL MARKINGS

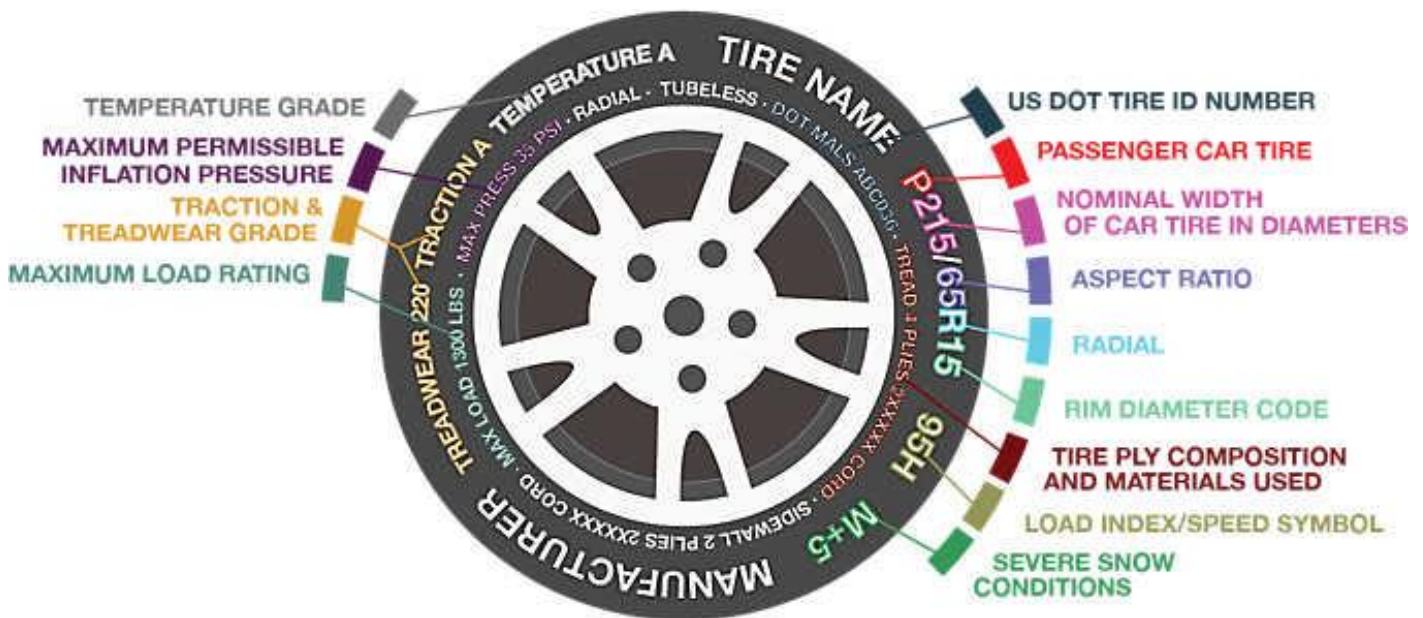

Next number—This two-digit number, known as the aspect ratio, gives the tire’s ratio of height to width. Numbers of 70 or lower indicate a short sidewall for improved steering response and better overall handling on dry pavement.

R—The “R” stands for radial. Radial ply construction of tires has been the industry standard for more than 20 years.

Next number—This two-digit number is the wheel or rim diameter in inches. If you change your wheel size, you will have to purchase new tires to match the new wheel number.

Next number—This two or three-digit number is the tire’s load index. It is a measurement of how much weight each tire can support. You might find this information in your owner’s manual. If not, contact a local tire dealer.

NOTE: You might not find this information on all tires because it is not required by law.

M+S—The “M+S” or “M/S” indicates that the tire has some mud and snow capability. Most radial tires have these markings.

Speed Rating—The speed rating denotes the speed at which a tire is designed to be driven for extended periods of time.

U.S. DOT Tire Identification Number—This begins with the letters “DOT” and indicates that the tire meets all federal standards. The next two numbers or letters are the plant code where it was manufactured, and the last four numbers represent the week and year the tire was built. For example, the numbers 1612 means the 16th week of 2012. The other numbers are marketing codes used at the manufacturer’s discretion. This information is used to contact customers if a tire defect requires a recall.

Tire Ply Composition and Materials Used—The number of plies indicates the number of layers of rubber-coated fabric in the tire. In general, the greater the number of plies, the more weight a tire can support. Tire manufacturers also must indicate the materials in the tire, which include steel, nylon, polyester, and others.

Maximum Load Rating—This number indicates the maximum load in kilograms and pounds that can be carried by the tire.

Maximum Permissible Inflation Pressure—This number is the greatest amount of air pressure that should ever be put in the tire under normal driving conditions.

Vehicle Load Limits

Determining the load limits of a vehicle includes more than understanding the load limits of the tires alone. On a motorhome, there is a federal certification label that is affixed in the rear closet. The certification label will indicate the vehicle’s gross vehicle weight rating (GVWR). This is the most weight the fully loaded vehicle can weigh.

It will also provide the gross axle weight rating (GAWR). This is the most a particular axle can weigh. If there are multiple axles, the GAWR of each axle will be provided. For motorhomes, in the same location as the certification label described above, there is a vehicle placard in the entry doorframe. This placard provides tire and loading information. In addition, this placard will show the vehicle’s seating capacity for people and a statement regarding maximum cargo capacity.

Cargo Capacities

For motorhomes, cargo can be added to the vehicle, up to the maximum weight specified on the placard. For motorized vehicles, the combined weight of passengers and cargo is provided as a single number. If fewer people are traveling, more cargo can be added. If more people are involved, the weight of cargo must be reduced. In any case, the total weight of a fully loaded vehicle, including passengers, cannot exceed the stated GVWR.

For motorhomes, the water and propane also need to be considered. The weight of fully filled propane containers is considered part of the weight of the RV before it is loaded with people or cargo and is not considered part of the disposable cargo load. Water, however, is a cargo weight and is treated as such. If there is a fresh water storage tank of 50 gallons, this tank when filled would weigh about 400 pounds. If more cargo or people are being transported, water can be off-loaded to keep the total amount of cargo added to the vehicle within the limits of the GVWR so as to not overload the vehicle.

Understanding this flexibility will allow you to make choices that fit your travel and camping needs. When loading your cargo, be sure it is distributed evenly to prevent overloading from front to back and

side-to-side. Heavy items must be placed low and as close to the axle positions as reasonable. Too many items on one side might overload a tire.

The best way to know the actual weight of the vehicle is to weigh it at a certified public scale. Talk to your RV dealer to discuss the weighing methods needed to determine the various weights related to the RV. This will include weights for axles, wheels, hitch, and total weight.

How Overloading Affects Your RV and Tires

The results of overloading can have serious consequences for passenger safety. Too much weight on your vehicle's suspension system can cause spring, shock absorber, or brake failure, handling or steering problems, irregular tire wear, tire failure, or other damage.

An overloaded vehicle is hard to drive and hard to stop. In cases of serious overloading, brakes can fail completely, particularly on steep hills. The load a tire will safely carry is a combination of the size of tire, its load range, and corresponding inflation pressure.

Excessive loads and/or under-inflation cause tire overloading and, as a result, abnormal tire flexing occurs. This situation can generate an excessive amount of heat within the tire. Excessive heat might lead to tire wear and eventually, tire failure.

It is the air pressure that enables a tire to support the load, so proper inflation is critical. Since RVs can be configured and loaded in many ways, air pressures must be determined from actual loads (determined by weighing) and taken from the load and inflation tables provided by the tire manufacturer. These air pressures might differ from those found on the certification label. However, they must never exceed the tire limitation for load or air pressure.

Tire Safety Tips

Preventing Tire Damage

- Slow down if you have to go over a pothole or other object in the road.
- Do not run over curbs or other foreign objects in the roadway, and try not to strike the curb when parking.

Tire Safety Checklist

- ✓ Check tire pressure regularly (at least once a month), including the spare.
- ✓ Inspect tires for uneven wear patterns on the tread, cracks, foreign objects, or other signs of wear or trauma.
- ✓ Remove bits of glass and foreign objects wedged in the tread.
- ✓ Make sure your tire valves have valve caps.
- ✓ Check tire pressure before going on a long trip.
- ✓ Do not overload your vehicle. Check the Tire Information and Loading Placard or User's Manual for the maximum recommended load for the vehicle.

SECTION TWO

Steps for Determining Correct Load Limit

Locate the statement “The combined weight of occupants and cargo should never exceed XXX lbs” on your vehicles placard.

Determine the combined weight of the driver and passengers that will be riding in your vehicle.

Subtract the combined weight of the driver and passengers from XXX kilograms or XXX pounds.

The resulting figure equals the available amount of cargo and luggage capacity. For example, if “XXX” equals 1400 lbs. and there will be five 150 lb. passengers in your vehicle, the amount of available cargo and luggage capacity is 650 lbs. $(1400 - 750 (5 \times 150) = 650 \text{ lbs.})$

Determine the combined weight of luggage and cargo being loaded on the vehicle. That weight may not safely exceed the available cargo and luggage capacity calculated in Step #4.

If your vehicle will be towing a trailer, load from your trailer will be transferred to your vehicle. Consult this section to determine how this reduces the available cargo and luggage capacity of your vehicle.

SECTION THREE

Glossary of Tire Terminology

Accessory weight—The combined weight (in excess of those standard items, which may be replaced) of automatic transmission, power steering, power brakes, power windows, power seats, radio and heater, to the extent that these items are available as factory-installed equipment (whether installed or not).

Bead—The part of the tire that is made of steel wires, wrapped or reinforced by ply cords and that is shaped to fit the rim.

Bead separation—This is the breakdown of the bond between components in the bead.

Bias ply tire—A pneumatic tire in which the ply cords that extend to the beads are laid at alternate angles substantially less than 90 degrees to the centerline of the tread.

Carcass—The tire structure, except tread and sidewall rubber which, when inflated, bears the load.

Chunking—The breaking away of pieces of the tread or sidewall.

Cold-inflation pressure—The pressure in the tire before you drive.

Cord—The strands forming the plies in the tire.

Cord separation—The parting of cords from adjacent rubber compounds.

Cracking—Any parting within the tread, sidewall, or inner liner of the tire extending to cord material.

CT—A pneumatic tire with an inverted flange tire and rim system in which the rim is designed with rim flanges pointed radially inward and the tire is designed to fit on the underside of the rim in a manner that encloses the rim flanges inside the air cavity of the tire.

Curb weight—The weight of a motor vehicle with standard equipment including the maximum capacity of fuel, oil, and coolant, and, if so equipped, air conditioning and additional weight optional engine.

Extra load tire—A tire designed to operate at higher loads and at higher inflation pressures than the corresponding standard tire.

Groove—The space between two adjacent tread ribs.

Gross Vehicle Weight Rating (GVWR)—The maximum permissible weight of this fully loaded motorhome.

Gross Axle Weight Rating (GAWR)—The value specified as the load carrying capacity of a single axle system, as measured at the tire-ground interfaces.

Hitch Weight—The vertical trailer load supported by the hitch ball.

Innerliner separation—The parting of the innerliner from cord material in the carcass.

Intended outboard sidewall—The sidewall that contains a white-wall, bears white lettering or bears manufacturer, brand, and/or model name molding that is higher or deeper than the same molding on the other sidewall of the tire or the outward facing sidewall of an asymmetrical tire that has a particular side that must always face outward when mounted on a vehicle.

Light truck (LT) tire—A tire designated by its manufacturer as primarily intended for use on light-weight trucks or multipurpose passenger vehicles.

Load rating—The maximum load that a tire is rated to carry for a given inflation pressure.

Maximum load rating—The load rating for a tire at the maximum permissible inflation pressure for that tire.

Maximum permissible inflation pressure—The maximum cold-inflation pressure to which a tire may be inflated.

Maximum loaded vehicle weight—The sum of curb weight, accessory weight, vehicle capacity weight, and production options weight.

Measuring rim—The rim on which a tire is fitted for physical dimension requirements.

Non-pneumatic rim—A mechanical device which, when a non-pneumatic tire assembly incorporates a wheel, supports the tire, and attaches, either integrally or separably, to the wheel center member and upon which the tire is attached.

Non-pneumatic tire assembly—A non-pneumatic tire, alone or in combination with a wheel or wheel center member, which can be mounted on a vehicle.

Normal occupant weight—This means 68 kilograms (150 lbs.) times the number of occupants specified in the second column of Table I of 49 CFR 571.110.

Occupant distribution—The distribution of occupants in a vehicle as specified in the third column of Table I of 49 CFR 571.110.

Open splice—Any parting at any junction of tread, sidewall, or innerliner that extends to cord material.

Outer diameter—The overall diameter of an inflated new tire.

Overall width—The linear distance between the exteriors of the sidewalls of an inflated tire, including elevations due to labeling, decorations, or protective bands or ribs.

Pin Weight—The vertical trailer load supported by the king pin of a fifth wheel hitch.

Ply—A layer of rubber-coated parallel cords.

Ply separation—A parting of rubber compound between adjacent plies.

Pneumatic tire—A mechanical device made of rubber, chemicals, fabric and steel, or other materials, that, when mounted on an automotive wheel, provides the traction and contains the gas or fluid that sustains the load.

Production options weight—The combined weight of those installed regular production options weighing over 2.3 kilograms (5 lbs.) in excess of those standard items which they replace, not previously considered in curb weight or accessory weight, including heavy duty brakes, ride levelers, roof rack, heavy duty battery, and special trim.

Radial ply tire—A pneumatic tire in which the ply cords that extend to the beads are laid at substantially 90 degrees to the centerline of the tread.

Recommended inflation pressure—This is the inflation pressure provided by the vehicle manufacturer on the Tire Information label and on the Certification/VIN tag.

Reinforced tire—A tire designed to operate at higher loads and at higher inflation pressures than the corresponding standard tire.

Rim—A metal support for a tire or a tire and tube assembly upon which the tire beads are seated.

Rim diameter—This means the nominal diameter of the bead seat.

Rim size designation—This means the rim diameter and width.

Rim type designation—This means the industry of manufacturer's designation for a rim by style or code.

Rim width—This means the nominal distance between rim flanges.

Section width—The linear distance between the exteriors of the sidewalls of an inflated tire, excluding elevations due to labeling, decoration, or protective bands.

Sidewall—That portion of a tire between the tread and bead.

Sidewall separation—The parting of the rubber compound from the cord material in the sidewall.

Test rim—The rim on which a tire is fitted for testing, and may be any rim listed as appropriate for use with that tire.

Tread—That portion of a tire that comes into contact with the road.

Tread rib—A tread section running circumferentially around a tire.

Tread separation—Pulling away of the tread from the tire carcass.

Treadwear indicators (TWI)—The projections within the principal grooves designed to give a visual indication of the degrees of wear of the tread.

Vehicle capacity weight—The rated cargo and luggage load plus 68 kilograms (150 lbs.) times the vehicle's designated seating capacity.

Vehicle maximum load on the tire—The load on an individual tire that is determined by distributing to each axle its share of the maximum loaded vehicle weight and dividing by two.

Vehicle normal load on the tire—The load on an individual tire that is determined by distributing to each axle its share of the curb weight, accessory weight, and normal occupant weight (distributed in accordance with Table I of CFR 49 571.110) and dividing by 2.

Weather side—The surface area of the rim not covered by the inflated tire.

Wheel center member—In the case of a non-pneumatic tire assembly incorporating a wheel, a mechanical device which attached, either integrally or separably, to the non-pneumatic rim and provides the connection between the non-pneumatic rim and the vehicle; or, in the case of a non-pneumatic tire assembly not incorporating a wheel, a mechanical device which attaches, either integrally or separably, to the non-pneumatic tire and provides the connection between tire and the vehicle.

TIRE PRESSURE

Correct tire inflation pressure is essential to maximizing the life of the tires and assuring the safety of the vehicle and its occupants. Driving with tires that are not correctly inflated for the load of the motorhome is dangerous and might cause premature wear, tire damage, and/or loss of control of the motorhome.

An underinflated tire will build up excessive heat that might actually approach the vulcanization temperature of the rubber and lead to tread separation and/or disintegration of the tire.

Underinflated tires will also cause poor handling of the motorhome, rapid and/or irregular tire wear, and an increase in rolling resistance of the motorhome, which in turn, produces a decrease in fuel economy of operation.

An overinflated tire will reduce the tire's "footprint" (i.e., its actual contact with the road); thus, reducing the traction, braking capacity, and handling of the motorhome. A tire that is over-inflated for the load that it is carrying will also contribute to a harsh ride, uneven tire wear, and the tire itself will be more susceptible to impact damage.

Maintaining correct tire pressure for each loaded wheel position on the motorhome is critically important and must be a part of regular vehicle maintenance.

Tire Maximum Load Rating

Federal law requires that the maximum load rating be molded into the sidewall of the tire. If you look at a tire sidewall, you might see some "typical" information, such as:

Max. Load Single 3640 Lbs. at 85-psi cold

Max. Load Dual 3415 Lbs. at 85-psi cold

The maximum load allowed for the size of the tire and load rating and the minimum cold air-inflation pressure needed to carry that stated maximum load are noted on the tire. Using less air pressure would reduce the load-carrying capacity of the tire.

NOTE: The amount of air pressure you need depends on the weight of the fully loaded motorhome. You cannot determine the correct air-inflation pressure, unless you know the actual weights of the motorhome.

Weighing the Motorhome

Earlier, in Chapter **Error! Reference source not found.**, the procedures for weighing the motorhome were presented. These procedures provided the weighing of a “non-loaded” (i.e., not stocked with the possessions and provisions the user would normally have on board for travel) motorhome. Obviously, any additional weight stored on board (inside and underneath) the motorhome will contribute to the overall weight of the motorhome.

If not stored uniformly throughout the motorhome, additional weight of the possessions and provisions of the motorhome user will load each axle and each tire differently (front-to-rear and side-to-side distribution of that additional weight). Accordingly, **it is necessary to weigh the motorhome fully loaded, as the user would have it for travel.** Moreover, **it is necessary to weigh each tire position individually.**

Overloading the motorhome can produce problems with the tires, wheels, springs, brakes, drive train, and other motorhome assemblies. In addition, an overloaded motorhome uses more fuel, is more difficult to handle properly, and can lead to driver fatigue more quickly. In a worst-case condition, if any component should fail, this could result in loss of control of the motorhome and subsequent damage.

In certain states, the Highway Patrol routinely weighs motorhomes to check for overloaded axle weights. Therefore, there are many good reasons for assuring that the motorhome is properly loaded and not overloaded—this can be accomplished through a proper weighing of the fully loaded motorhome.

You can find various places that have certified public scales where your motorhome can be weighed. For example, moving and storage company lots, farm suppliers with grain elevators, gravel pits, recycling companies, and large-scale commercial-truck stops are some of the possible locations for weighing the motorhome. You can also check the Yellow Pages of the telephone book for “scales – public” or “weighers” to determine other locations for weighing the motorhome.

A brief overview of the procedure for weighing the motorhome

WEIGHING YOUR SINGLE AXLE RECREATIONAL VEHICLE

RV: To Obtain Individual Axle and Gross Vehicle Weights:

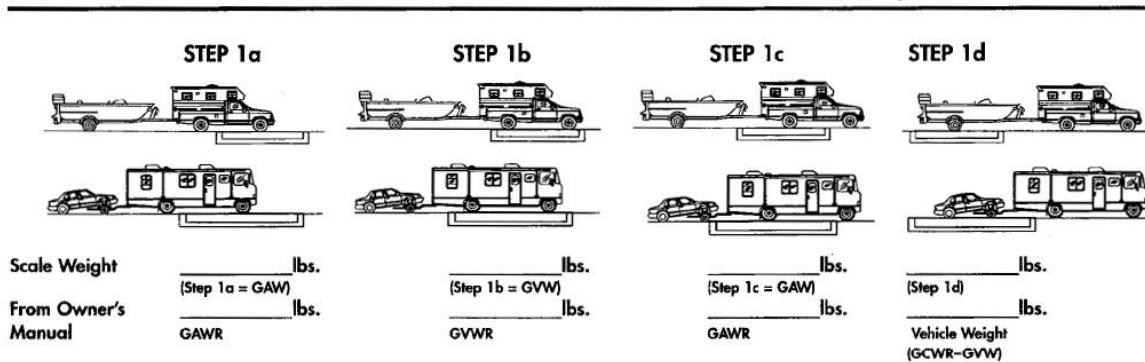

To Obtain Individual Wheel Position Weights:

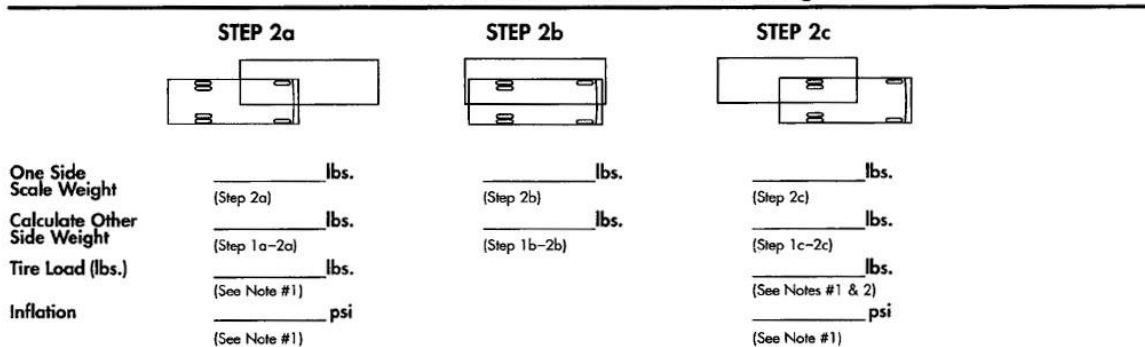

Figure 0-4: Motorhome Weighing Procedures

NOTE: Tire manufacturer's load and inflation tables can be found on the sidewall of the tires mounted on the motorhome.

NOTE: If the motorhome has duals, read dual capacity from the tire and multiply by 2 (two) to obtain dual-assembly load-carrying capacity.

More detailed information can be found in the manufacturer's literature associated with the chassis and/or the tires provided with the motorhome. For example, the above graphic illustrates the inflation pressures for Michelin tires as a function of the loads per position for a specified speed of the motorhome. You can determine the appropriate inflation pressures for each of the tires on the motorhome, as a function of the loads they are to carry on a trip. Whenever there is a significant change in the loading regimen of the motorhome, it would be wise to re-calculate the load weights of the tires to ensure optimal use of the motorhome.

Frequency of Checking Tire Inflation Pressures

When you have determined the “correct” tire inflation pressures for each of the motorhome tires (Figure 0-5 and Figure 0-6) and inflated the tires under “cold” conditions, meaning the tires haven’t been driven for more than one mile, then the air pressures in the tires must be periodically checked to make sure that they retain their proper pressures. It is recommended that tire pressures be checked at least once a month, or preferably, every two weeks, and before any major trip.

On long trips, the tires must be checked every “drive” morning. On short trips (a day or less), the tires must be checked before one departs on the trip and again before one returns home.

Check tire pressures when they are “cold”; that is, the tires have not been driven at all or, at most, less than one mile before being measured. In this manner, the tire pressure has not been increased by the heating associated with tire sidewall and tread flexure associated with traveling. If you check tires that are warm or hot, remember that they will necessarily read higher than normal. Do not “bleed” these tires down to the “cold pressure” readings, as they will probably then be underinflated when they are actually cool.

Do not make any adjustments to tire pressures when the tires are warm or hot, if such can be avoided. To make these tire-pressure measurements, purchase a high-quality truck-tire air gauge, which has an angled dual head. This type of gauge enables you to check inflation pressures of both the inner dual wheel, which has the valve stem pointing toward one, and on the outer wheel, which has the valve stem pointing away from one.



Figure 0-5: Rear Tire



Figure 0-6: Front Tire

Pressure-sealing valve caps must always be used to protect the valve stems and prevent air from escaping from the valve stems.

Tire Wear, Balance, and Wheel Alignment

In addition to tire inflation considerations, the tires must also be periodically examined for other types of normal “wear and tear.” If installed and maintained properly, all tires mounted on the motorhome will wear in a smooth, even pattern. If the tires begin to show irregular wear patterns and the motorhome alignment is still correct, then sometimes just rotating the tires by changing wheel position and rotation of the tires will allow the tires to wear evenly.

Check with the chassis manufacturer (Power Glide) and its literature in the Owner’s Information Package for particulars on maintaining proper wheel alignment.

Tire Cleaning

Proper cleaning of the tires will ensure maximum years of service. A soft brush and the normal mild soap must be used to clean the tires. Use care in applying any tire “dressing” product as these contain petroleum derivatives, alcohol, or silicones, which might cause deterioration of the rubber, possibly leading to cracking, and accelerate the aging process. In many instances, it is not the actual dressing itself, but the reaction of that product with the antioxidant in the tire. Heat can also compound this problem.

INTERIOR CARE

NOTICE

The fading of upholstery, carpet, and other interior fabrics is generally caused by excessive sunlight. The drapes, blinds, or other shades must be kept closed when the vehicle is parked for an extended period of time to minimize the fading. Normal deterioration of the appearance of such items caused by wear and/or exposure to strong lighting is not covered by the Tiffin Motorhomes Limited Warranty.

Carpet

A weekly routine of vacuuming the carpet and fabrics throughout the vehicle is recommended. The optional vacuum system has a central connection within the motorhome wherein a vacuum hose can be connected and the necessary vacuuming performed, as desired.

Remember to empty or replace vacuum bags before they become overly full — this practice will ensure that sufficient vacuuming capability is readily available to handle all cleaning situations that might arise. In carpet areas that receive the most sunlight, keeping the curtains closed whenever possible will minimize fading. Also, act quickly when anything is spilled or dropped onto the carpet to prevent or minimize staining.

To connect the cleaning hose, raise the wall remote inlet valve door and align hose-end coupling with the slots on each side of the intake opening. Firmly push into the intake opening. Make sure the hose-end coupling is connected and is locked in place. To disconnect the hose, push in the slots on each side of the hose coupling and pull the hose end straight out.

NOTE: The vacuum cleaner hose must be plugged into the outlet to activate the vacuum motor.

To start the vacuum cleaner:

Lift inlet valve cover on the wall.

Insert the hose cuff with a twist and push. The vacuum cleaner will start automatically.

To remove, turn the hose in either direction while pulling the hose toward you.

To change the dust bag, you will need to open the door on the vacuum cleaner by pushing the latch upward and removing the door completely. Remove the full bag and discard. Next, locate the pipe inside the vacuum chamber. Holding the new bag's cardboard collar at approximately a 45-degree angle, insert the cardboard part of the bag against the upper back of the vacuum cleaner chamber behind the pipe. Lift the front of the collar over the pipe as far as possible.

**WARNING**

This appliance has a THERMAL PROTECTOR built in the motor to prevent overheating. If the motor will not operate or shuts down while in operation, wait for 30 minutes; it will reset automatically. Turn the unit OFF while it resets. If the motor does not come on, or Thermal Protector trips off again after a short period, service might be needed. A qualified service technician must perform the service.

When closing the door, tuck in the left and right corners of the bag so that the door is properly sealed and the latch clicks into place. The vacuum cleaning system comes with an array of attachments that can be connected to the hose ends for extensive cleaning purposes. Make sure they are firmly pushed in, and twist to hold in place.

For further instructions to change the dust bag, use the attachments, and proper cleaning technique, refer to the specific Owner's Manual located in your motorhome.

FABRICS



Figure 0-7: Fabrics

The fabrics (Figure 0-7), used in this Tiffin motorhome for the bedspread, draperies, headboard, and valances contain fire-retardant additives that might be damaged by use of improper cleaning products.

These items are DRY CLEAN ONLY. Water-based products are not recommended for cleaning the fabrics in your new vehicle. Most water-based, household-cleaning products are not formulated for use on these fabrics and might cause excessive shrinkage or fading. For best results, the fabrics in this vehicle must be cleaned by a professional carpet and upholstery cleaner.

Spills, spots, or stains must be treated as soon as possible to avoid permanent damage to the fabrics. If a spill occurs, blot the fluid with a dry towel, do not rub the spill as rubbing might cause the liquid to "set" in the fabric and cause a stain. When attempting to clean a spot or stain, always start from the outside

and work inward to avoid spreading the stain further. Some stains or soils are extremely difficult or impossible to be removed completely. These stains must receive immediate professional attention. Spills, spots, stains, or soiled areas are the responsibility of the owner and are not covered by Tiffin Motorhomes Limited Warranty.

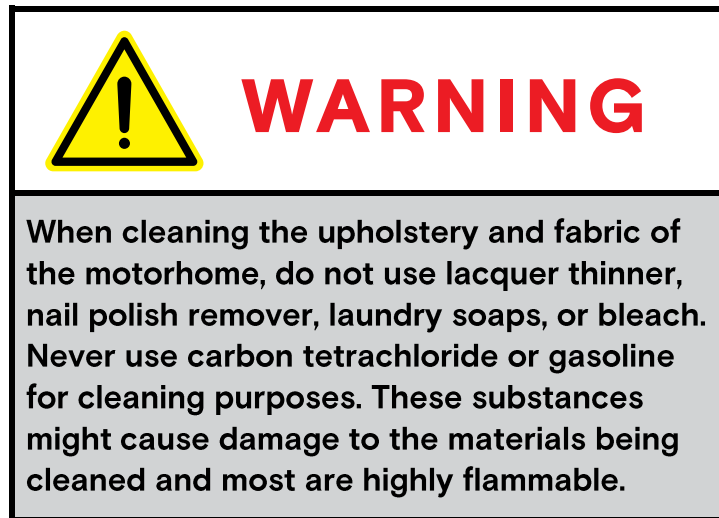

WALLS & CEILING

The wall and ceiling coverings must be cleaned periodically to maintain a new appearance. Use a non-abrasive cleaner with a soft cloth on the walls. Do not use solvents of any kind, as those solvents might damage the surfaces being cleaned.

DASHBOARD

To keep the motorhome dashboard (Figure 0-8) in like-new condition, regularly follow these guidelines:

DOs

- Dust and clean the dashboard with a soft, damp cloth or chamois, wiping the service gently.
- Use a mild detergent and lukewarm water.
- After washing and rinsing the dashboard, dry it by blotting with a damp cloth or chamois.



Figure 0-8: Dashboard

DON'Ts

- Use harsh chemicals that might damage the dashboard.
- Use cloths containing grit or abrasive particles or kitchen-scouring compounds to clean or dust the dashboard.
- Subject the dashboard to hard, direct blows.
- Use boiling water, strong solvents, or other such materials to clean the dashboard, as they will soften

the plastic.

WOODWORK & FLOORS

The wood cabinetry must be cared for with furniture polish to sustain the natural beauty and luster of the wood. This procedure will also keep the cabinetry (Figure 0-9) looking new, prevent the wood from drying, and reduce chances of accidental staining or aging.

Use area rugs and floor mats by the entrance door to trap dirt.

Use soap and water to clean the flooring, begin by vacuuming the floor to remove loose dust and dirt. Then, damp mop the floor with a cleaning solution consisting of any standard cleaning solution. The mop must be damp, but not dripping. For further tips, see the manufacturer's information sheet in your Tiffin Motorhomes Owners Information Package.



Figure 0-9: Kitchen Cabinetry

COUNTERTOPS

To care properly for the countertops in your new vehicle, always use a heat pad or trivet to protect the surface from hot objects that might mar or damage the countertop surface. Hot pans and heat-producing appliances (such as electric skillets), when set directly on top of the countertop, can possibly mar the beauty and finish of the product.

Additionally, since heat-producing appliances can also damage countertop seams, it is essential to check with Tiffin Motorhomes to identify seam locations to avoid them during subsequent use of the motorhome. Although solid surfacing is repaired easily, certain steps must be taken to protect it.

Be sure to use a cutting board, rather than cutting directly on the countertop (Figure 0-10) surfaces. Although minor scratches and cuts can be repaired, a little care will ensure that the counter-top surfaces will keep looking new for years.

Avoid using harsh chemicals on the countertop. Wipe the countertop with a damp cloth to remove water spots. For most dirt and stains, wipe with a damp cloth and use soapy water or ammonia-based cleaners (e.g., Windex). If a stain does not respond to soap and water, for a matte finish, apply an abrasive cleanser and buff it with a Scotch-Brite pad, using a circular motion. Use the same technique in the case of a cigarette burn. If the finish is a gloss finish, contact the dealer for specific cleaning instructions.

Do not expose the surface to harsh chemicals, such as paint remover, turpentine, nail polish remover, or any stove and drain cleansers. If these chemicals come into contact with the countertop surfaces, immediately wash off these chemicals, using appropriate safety measures to avoid injury.

In the event of subsequent staining or spotting, sand the affected surface lightly with fine sandpaper (400 grit or finer), then buff in a circular motion with a Scotch-Brite pad.



Figure 0-10: Kitchen Countertops

ACCESSORIES

The metallic light fixtures, bath accessories, and faucets can be cleaned by wiping with a soft, damp cloth. Washing with warm water will remove dry water spots. Polishing those fixtures with a soft cloth will also enhance their appearance. Do not use cleaners that contain harsh or abrasive chemicals. Alcohol or other similar solvents must never be used.

DETECTORS

The CO/LP gas detectors (Figure 0-11) are self-contained and DO NOT require any maintenance other than normal cleaning and periodic testing. The smoke detector installed in the motorhome is a 9 volt, battery-operated detector. The CO/LP gas detector is wired directly to the house batteries.

The batteries in the smoke detector need to be tested periodically and replaced when necessary. When cleaning the case on any of the detectors, use a damp cloth or paper towel. Do not spray cleaners or wax directly into the case as this action might cause false alarms or hinder the normal operation of the detectors.

Tiffin Motorhomes recommends purchasing an inexpensive battery tester. This tester will allow checking of the batteries in the various alarms, any flashlights used in the motorhome, and batteries in other appliances, which might be in the motorhome during travels.



Figure 0-11: Smoke Detector

CONDENSATION

NOTICE

Since surface condensation within the motorhome cannot be controlled by the manufacturer, damage caused by condensation is not covered by the Tiffin Motorhomes Limited Warranty.

Damage might occur to your vehicle if excessive condensation exists. Accumulation of condensation on surfaces within your motorhome occurs when warm, moist air contacts a cool surface. It is most evident on the inside of windows, but this problem can be controlled by:

Slightly opening a window or roof vent to allow the moisture to escape from the motorhome.

Using a small dehumidifier to remove moisture from the air.

Condensation levels are highest during times when a person is cooking or taking a shower in the motorhome, but these occasions are not the only times that condensation is present. Walls and ceiling panels might become wet when the moisture accumulates on these surfaces. Tiffin Motorhomes does not recommend the use of any catalytic heaters because of resulting extensive condensation.

ROUTINE MAINTENANCE SCHEDULES

NOTICE

Always follow the chassis maintenance guidelines outlined in the chassis manufacturer's owner's manual.

All routine maintenance is the responsibility of the owner and is not covered by the Tiffin Motorhomes Limited Warranty. Use the maintenance record in Chapter 0 to record all performed maintenance as required.

Any damage caused by improper or unperformed maintenance is not covered by the Tiffin Motorhomes Limited Warranty. Items supplied by other manufacturers might require specific individual maintenance not listed herein. Refer to the manufacturers' suggested maintenance guidelines in the Owners Information Package.

NOTICE

Cosmetic adjustments and alignments must be performed within the first three months from the date of original purchase for warranty consideration. Thereafter, these items are considered routine maintenance.

Monthly

- Check the water levels of the batteries.

Every Three Months

- Check LP gas lines for leaks with soap solution or leak detector.
- Clean the microwave hood exhaust fan filter and blades.
- Test smoke alarm and carbon monoxide/LP gas detector.
- Check operation of windows, latches, and hinges.
- Clean the roof-ducted air conditioner filters.
- Clean and inspect door and window seals; reseal where necessary.

- Inspect and reseal around the tub and shower area where necessary.
- Lubricate the exterior door hinges and latches with a graphite (silicone) lubricant.
- Check, clean, and tighten battery cables and inspect batteries for proper fluid levels.

Every Six Months

- Inspect the slide-out for proper seal. If realignment is necessary, contact an authorized Tiffin Motorhomes Service Center.
- Inspect the exterior rubber slide-out seals and apply a UV inhibitor, such as 303 Protectant.
- Change the battery in the smoke detector.
- Rotate tires as recommended by the tire manufacturer.
- Check all gas appliances for proper operation.
- Have the LP system inspected by a qualified technician.
- Lubricate the movable parts on the entrance step.
- Change the batteries in both the smoke detectors.
- For the optional washer/dryer, inspect the water hoses (both the hot and cold supply lines) to note any bulges, kinks, cuts, wear, or leaks. Especially note the hot-water hose, as this tends to degrade faster than the cold-water hose. Replace if hose feels “soft” or “spongy.”

Annually

- Inspection of roof seams and joints must be performed by an authorized Motorhomes Service Center. If resealing is necessary, it is the owner’s responsibility and is not covered by the Tiffin Motorhomes Limited Warranty.
- Sanitize the fresh water system.
- Wax and buff all gel-coat surfaces on the vehicle as described previously in this chapter.

WINTERIZING

To store your vehicle for the winter months, it is necessary to winterize the water system to help prevent freezing of this system. If your unit has a Truma Water Heater, be sure to follow the instructions in the Operations Manual. The control panel is located in the bedroom closet.

IMPORTANT: Turn off the water heater before draining to prevent burning the element out.

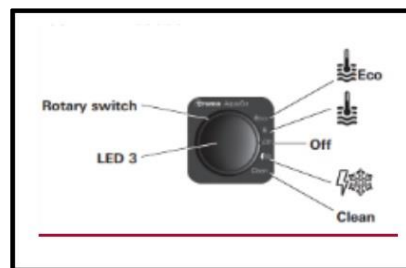

Figure 0-12: Truma Switch

Drain all the water from the water system including the holding tanks, the hot water heater, and freshwater tank. Also, drain the water filter. For the holding tanks, open the gate valves to drain the tanks.

NOTE: This procedure is to be performed only at a wastewater pumping station to prevent dumping of contaminated water elsewhere.

For the hot water heater, remove the outside cover and then remove the drain plug. When this tank is drained, replace the drain plug and then replace the cover. For the water tank, open the red-handled valve to drain the tank; then close the valve. Remove the filter cartridge from the water filter and store it in a clean environment. Empty any excess water from the filter housing and replace the housing.

Turn the by-pass valve located in the exterior sanitation compartment to the “by-pass” position to prevent filling the water heater tank with antifreeze.

Disconnect the inlet connection to the water pump located in the sanitary service compartment under the motorhome. Attach the supplied vinyl hose (through the plastic coupling on the hose) to the inlet connection and hand-tighten that connection. Do not over-tighten.

Place the other end of the hose into a gallon of freshwater system antifreeze (one can refer to the local Tiffin Motorhomes dealer or representative for the freshwater antifreeze formulation for your specific area).

NOTE: Do not use automotive antifreeze; use only antifreeze approved for RV applications. Otherwise, damage to the systems being protected might result.

Turn ON the water pump to start the flow of antifreeze. Turn ON each faucet, one at a time and allow pure antifreeze to run through that piping. Let about one cup drop into the drains to protect the traps.

When all the antifreeze is withdrawn from the bottle, disconnect the clear vinyl hose from the water-pump inlet connection and reconnect the inlet line to the water pump. (This might require more than one gallon of antifreeze).

When the winterizing process is completed, turn the water pump OFF and then reconnect the water line. Store the vinyl hose for future use.

Open the water supply valve that controls flow from the pump to the tank to help prevent freezing on that water line.

NOTE: The motorhome also has an exterior shower that must be winterized, as well.

Residential Refrigerator Ice Maker (optional)

Unplug refrigerator or disconnect power.

Locate the water supply shut off valve and turn OFF the water supply.

Disconnect the water supply line at the refrigerator and drain the supply line completely.

Locate the icemaker fill tube at the rear of the refrigerator and follow the water line down to the water valve.

Remove any covers if necessary.

Disconnect the water line from the water valve, and drain the water from the line and the valve. Use a small pan to catch water.

Remove the water filter cartridge (if applicable.)

NOTE: Reinstall a new water filter cartridge when the refrigerator is put back into service.

DE-WINTERIZING

Follow the instructions in your water system's Operations Manual.

Open both of the low-point drains to allow the antifreeze solution to drain from the water system.

Close the low-point drains and connect your vehicle to the city water system. Put water in the freshwater tank and pump at least one gallon through the water pump to remove the antifreeze from the water pump. Keep the water heater in the bypass mode.

Open the kitchen faucet, bath faucet, and inside and outside showers, turning ON both the hot and cold-water valves and flushing the stool until the antifreeze solution is flushed out of the system and the water flow is clear.

Open the water heater bypass valve. Open the freshwater tank supply valve from the pump and the icemaker valve.

Reinstall the (optional) water filter. Fill the water heater and hot water lines before turning the water heater on.

Be sure to close the fresh water tank drain valves to allow the tank to fill.



MAINTENANCE & DATA CHARTS

Chapter

17

RV OWNER DATA SHEET

Enter the following information in the table for your future use:

BYWAY: Year: _____ Model # _____ Tiffin Serial # _____			
Appliance	Brand	Model No.	Serial No.
Refrigerator			
Water heater			
Microwave			
Inverter/Converter			
Television, Front			
Back-up monitor			
Stereo/CD			
DVD home theater			
Air conditioner			
Generator			

Reproduction Master – Copy this sheet and use copy to maintain your maintenance records. You might wish to keep the completed sheets in a three-ring binder for your permanent record.



TIFFIN

MOTORHOMES

Tiffin Motorhomes, Inc. | 105 2nd St. NW | Red Bay, AL 35582
tiffinmotorhomes.com

Phone: 256-356-8661 | Email: info@tiffinmotorhomes.com

To view or download a full color, printable version of this owner's manual, visit
www.tiffinmotorhomes.com/resources/owners-manual

OR SCAN BELOW

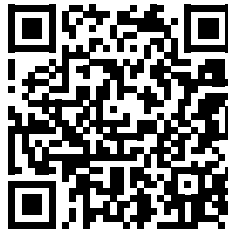

Because of progressive improvements and specifications, standard and optional equipment are subject to change without notice or obligation. For a complete and up-to-date list of available options and specifications, visit tiffinmotorhomes.com.

©2024 Tiffin Motorhomes, Inc.

®, Breeze®, RED®, Phaeton®, Bus®, Zephyr®, Wayfarer®, Roughing It Smoothly®, Open Road®, PowerGlide®, and Cahaba® are registered trademarks of Tiffin Motorhomes, Inc. All rights reserved.