



DESIGNED TO MOVE [YOU][®]

JWM90A

MOBILE AUDIO SYSTEM

Installation and Owner's Manual

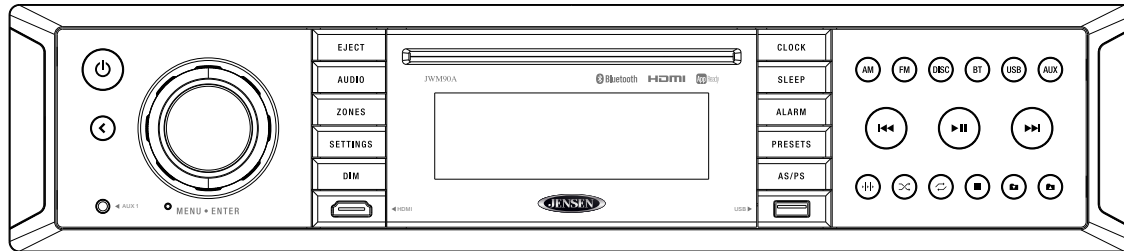

Introduction.....	3
Disc Notes.....	4
Installation.....	5
Wiring.....	6
Basic Operation.....	7
Multi-Source Setup and Operation.....	11
Tuner Operation.....	12
Disc Operation.....	13
MP3/USB Operation.....	16
Bluetooth Operation.....	18
App Operation.....	19
Remote Control Operation.....	20
DVD Setup Menu.....	22
Care and Maintenance.....	24
Troubleshooting.....	24
Specifications.....	25
FCC Notes	25

INTRODUCTION

Thank You!

Thank you for choosing a Jensen product. We hope you will find the instructions in this owner's manual clear and easy to follow. If you take a few minutes to look through it, you'll learn how to use all the features of your new Jensen receiver for maximum enjoyment.

Features

Features of Jensen JWM90A mobile audio system include:

- Multi-Source Playback Support
- Independent Zone Volume Control
- Digital AM/FM Tuner/30 Preset stations (12AM/18 FM)
- Bluetooth Ready with A2DP/AVRCP Streaming Audio
- APP Ready(iOS and Android)
- Pre-set Equalizer -5 settings (User > Flat > Pop > Classical > Rock)
- Electronic Controls for Volume, Bass, Treble, Balance, Fader and Subwoofer
- DVD/CD-R/RW and MP3 Compatible
- HDMI Video Output with JCOM link
- HDMI ARC
- Time/Alarm Clock
- White LED Backlit LCD
- 1/8" Front Auxiliary Audio Input
- Rear Audio RCA Inputs/Outputs
- USB Playback of MP3/WMA Files
- 3 Zone / 8 Speaker Output
- Wireless Remote Control Included

Precautions

- **Use the Proper Power Supply.**
This product is designed to operate with a 12 volt DC, negative ground battery system (the standard system in a North American vehicle).
- **Protect the Disc Mechanism.**
Avoid inserting any foreign objects into the slot of this player. Failure to observe this may cause malfunction due to the precise mechanism of this unit.
- **Use Authorized Service Centers.**
Do not attempt to disassemble or adjust this precision product; contact a professional for assistance.

- **Avoid Moisture.**

To reduce the risk of fire or electric shock, do not expose this equipment to rain or moisture.

- **Avoid Cleaning Products.**

The front of this unit should only be cleaned with a slightly damp cloth. Do not use cleansers.

- **Use Recommended Accessories.**

TO REDUCE THE RISK OF FIRE OR ELECTRIC SHOCK AND ANNOYING INTERFERENCE, USE ONLY THE RECOMMENDED ACCESSORIES.

CAUTION: This mobile DVD player is a Class I laser product that uses a visible/invisible laser beam which could cause hazardous radiation exposure if improperly directed. Be sure to operate the mobile DVD player as instructed. Use of controls or adjustments or performance of procedures other than those specified herein may result in hazardous radiation exposure. Do not open covers and do not attempt to repair the unit yourself. Refer servicing to qualified personnel.

Packing List

JWM90A

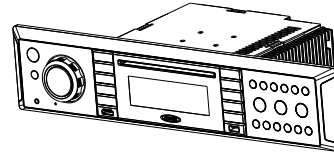

Remote Control

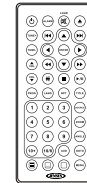

20-PIN Speaker Wire

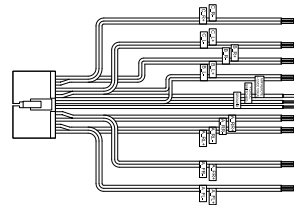

AUX AUDIO/VIDEO CABLE







DISC NOTES

Depending on the recording status, conditions of the disc, and the equipment used for recording, some CD-Rs/CD-RWs may not play on this unit. For more reliable playback, please adhere to the following recommendations:

- Use CD-RWs with speed 1x to 4x and write with speed 1x to 2x.
- Use CD-Rs with speed 1x to 8x and write with speed 1x to 2x.
- Do not play a CD-RW which has been written more than 5 times.

Disc Maintenance

- A dirty or defective disc may cause sound dropouts while playing. Before playing, wipe the disc using a clean cloth, working from the center hole towards the outside edge. Never use benzene, thinners, cleaning fluids, anti-static liquids or any other solvent.
- Be sure to use only round CDs for this unit and do not use any special shape CDs. Use of special shape CDs may cause the unit to malfunction.
- Do not stick paper or tape on the disc. Do not use CDs with labels or stickers attached or that have sticky residue from removed stickers.
- Do not expose discs to direct sunlight or heat sources such as hot air-ducts, or leave them in a vehicle parked in direct sunlight where there can be a considerable rise in temperature inside the vehicle.

			
Insert label side up.	Do not bend.	Never touch the underside of the disc.	Wipe clean from this center to the edge.

NOTE: A disc may become scratched (although not enough to make it unusable) depending on how you handle it and other conditions in the usage environment. These scratches are not an indication of a problem with the player.

INSTALLATION

It's a good idea to read all of the instructions before beginning the installation. We recommend having your Jensen JWM90A installed by a reputable RV dealership.

Tools and Supplies

You will need these tools and supplies to install your JWM90A:

- Phillips screwdriver
- Wire cutters and strippers
- Tools to remove existing radio (screwdriver, socket wrench set or other tools)
- Electrical tape
- Crimping tool
- Volt meter/test light
- Crimp connections
- 16 gauge wire for power connections
- 16 - 18 gauge speaker wire
- Four M3x20mm (3/32 x 0.75") screws

Disconnecting the Battery

To prevent a short circuit, be sure to turn off the ignition and remove the negative (-) battery cable prior to installation.

NOTE: If the JWM90A is to be installed in a vehicle equipped with an on-board drive or navigation computer, do not disconnect the battery cable. If the cable is disconnected, the computer memory may be lost. Under these conditions, use extra caution during installation to avoid causing a short circuit.

Selecting the Mounting Location

Select a mounting location, taking care to avoid the following:

- Places exposed to heat-radiating appliances such as electric heaters
- Adjacent to other equipment that radiates heat
- Poorly-ventilated or dusty places
- Moist or humid locations

Mounting the Radio

- Use the mounting hole diagram to measure and cut a mounting hole
- Route power, speakers, AV, and antenna cables through the hole and connect
- Check and ensure correct operation
- Mount the unit using four M3x20mm (3/32 x 0.75") screws
- Attach Trim ring

NOTE: Before cutting the mounting hole, make sure the area behind the mounting location is clear of wires, fuel and vacuum or brake lines.

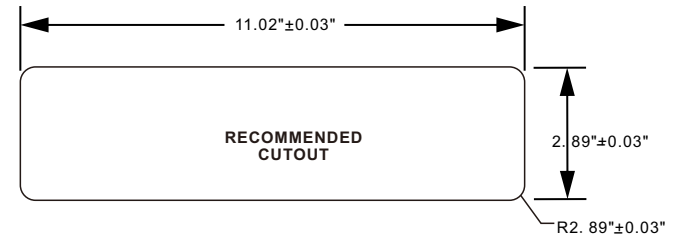

WIRING

The wiring diagram depicts all the wiring connections required for proper operation of the unit.

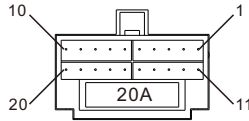

DETAIL A
SHOWN FROM PIN VIEW

PIN NO.	WIRE COLOR	DESCRIPTION
1	PINK/BLACK	RIGHT (C) SPEAKER (-)
2	PINK	RIGHT (C) SPEAKER (+)
3	GREEN	LEFT (C) SPEAKER (+)
4	GREEN/BLACK	LEFT (C) SPEAKER (-)
5	BROWN/BLACK	LEFT (B) SPEAKER (-)
6	GRAY	FRONT RIGHT (A) SPEAKER (+)
7	GRAY/BLACK	FRONT RIGHT (A) SPEAKER (-)
8	N/A	N/A
9	WHITE/BLACK	FRONT LEFT (A) SPEAKER (-)
10	WHITE	FRONT LEFT (A) SPEAKER (+)
11	ORANGE	RIGHT (B) SPEAKER (+)
12	ORANGE/BLACK	RIGHT (B) SPEAKER (-)
13	BROWN	LEFT (B) SPEAKER (+)
14	BLUE	AMP REMOTE (+12VDC 100mA)
15	RED	+12VDC SWITCHED
16	BLACK	GROUND
17	VIOLET	RIGHT REAR (A) SPEAKER (+)
18	VIOLET/BLACK	RIGHT REAR (A) SPEAKER (-)
19	LIGHT GREEN/BLACK	LEFT REAR (A) SPEAKER (-)
20	LIGHT GREEN	LEFT REAR (A) SPEAKER (+)

WARNING: Wiring harness comes with stripped and tinned leads to aid in the installation process. Any unused speaker wires must have their exposed ends cut off or insulated individually.

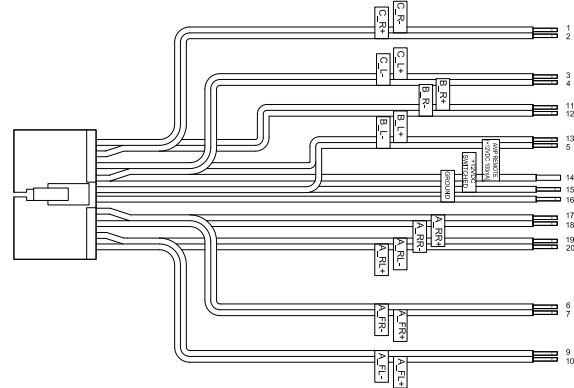

CONNECTIONS

The diagram below depicts all the available audio/video connections available to use with your system.

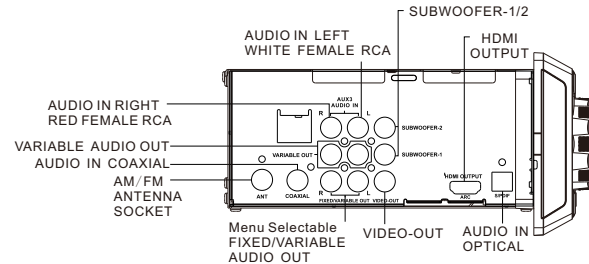

BASIC OPERATION

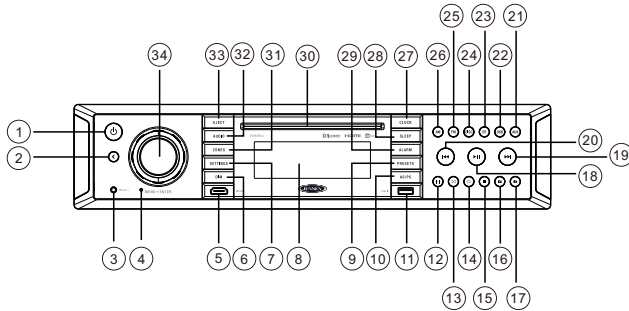

Power

Press the **POWER** button (1) to turn the unit on.
The unit will resume at the last mode (Tuner, Aux, etc.).

Zones Volume Control

1. Press the **ZONES** button (31) to enter the zone menu.
2. While in the zone menu, press **ZONES** (31), or the [**<<** or **>>**] buttons (20, 19) repeatedly to navigate through the zones menu settings (ZONE A mode, ZONE A volume adjustment, ZONE B mode, ZONE B volume adjustment, ZONE C mode and ZONE C volume adjustment).

NOTE: Zone A also controls the output of the rear line level audio output (When set to variable).

3. While in zone selection mode, rotate the **VOL/ENTER** knob (34) to select the active zone's mode. While in zone volume adjustment, rotate the **VOL/ENTER** knob (34) to adjust the volume for that zone.

Zone Mute

While in zone menu volume adjustment (see above), press and hold the **ENTER** knob button to mute the audio output of the active zone's volume. Rotate the **VOL/ENTER** knob (34) to restore the previous volume level.

Pause / Mute

During **RADIO / FRONT AUX / REAR AUX / COAXIAL / OPTICAL / HDMI ARC / HDMI IN** mode, press the **▶||** button (18) to mute the audio output for active zones. Press again to restore the previous volume level.

During **USB / DVD / BT** mode, press the **▶||** button to pause playback. Press again to resume playback.

Audio Menu Setting

1. Press the **AUDIO** button (32) to access the audio menu.
2. Press the [**<<** or **>>**] buttons (20, 19) or **AUDIO** button repeatedly to navigate through the audio menu items.
3. Once the desired menu item appears on the display, adjust that option by rotating the **VOL/ENTER** knob (34) clockwise or counter-clockwise within 5 seconds.
4. Press the **BACK** button (2) to confirm your selection and exit audio menu. The unit will automatically exit the audio menu after 5 seconds of inactivity.

The following items can be adjusted:

- **BASS:** Adjust the Bass level from "-7" to "+7".
- **TREBLE:** Adjust the treble from "-7" to "+7".
- **BALANCE:** Adjust the Balance between the left and right speakers output from "LEFT 7" (full left) to "RIGHT 7" (full right).
- "BALANCE 0" indicates equal balance between the left and right speakers.
- **FADE:** Adjust the speaker fade between the rear and front speakers from "REAR 7" (full rear) to "FRONT 7" (full front).
- "FADE 0" indicates equal balance between the rear and front speakers.
- **LOUDNESS:** Toggle the loudness on/off. When listening to music at low volumes, this feature will boost the bass/treble range to compensate for the characteristics of human hearing.
- **SUBWOOFER:** Set the subwoofer volume output. The maximum volume setting is "40".
- **EQUALIZATION:** Choose one of the following pre-defined bass and treble curves: POP > CLASSICAL > ROCK > FLAT.

System Menu Setting

1. Press the **SETTINGS** button (7) for 2 seconds to access the system menu.
2. Press the [**<<** or **>>**] buttons (20, 19) or **SETTINGS** button repeatedly to navigate through the system menu items.
3. Once the desired menu item appears on the display, adjust that option by rotating the **VOL/ENTER** knob clockwise or counter-clockwise within 5 seconds.
4. Press the **BACK** button (2) to confirm your selection and exit audio menu. The unit will automatically exit the audio menu after 5 seconds of inactivity.

The following items can be adjusted:

- **BLUETOOTH DEVICE** (Lock/Unlock, Disconnect/Connect, Delete): View, lock and delete from a list of previously paired mobile phone device models.
- **BLUETOOTH (ON/OFF)**: Choose "Bluetooth On" or Bluetooth Off".
- **BEEP (ON/OFF)**: Turn the audible beep On/Off (heard when functions/buttons are selected).
Note: Beep tone off will not affect the audible tone of the alarm clock.
- **REGION (USA/EUROPE)**: Set frequency spacing for various regions.
- **PRESET VOL (1-40)**: Select an automatic turn on volume.
- **RCA out VARIED/FIXED**: When VARIED is selected, the volume output of RCA out is adjustable by rotating the volume encoder knob. When FIXED is selected, the volume output of RCA out is fixed at maximum output.
- **RESET <ENTER>**: Press the **ENTER** button to return the JWM90A to factory default settings.

Auxiliary Input Function

When a portable audio device is connected to the unit, press the **AUX** button (21) repeatedly until FRONT AUX / REAR AUX mode is selectable, then press **ENTER** (34) knob to enter the FRONT AUX / REAR AUX mode. To connect a portable audio device, insert a standard 3.5mm (audio line output or headphone output from your portable CD / MP3 or other media player) into the AUX connector (AUX FRONT) (3) on the front of the unit or the AUX-IN RCA jack (AUX REAR) on the left chassis of the unit.

Auxiliary Input Connector

For front panel audio input, an external audio source can be connected to the front panel audio input with a 3.5mm audio cable adapter. Connect the device to the **AUX** connector (3) on the front panel.

In addition to front panel auxiliary input source, the unit can also be connected to the RCA audio input through the AUX-IN RCA jack on the left chassis of the unit.

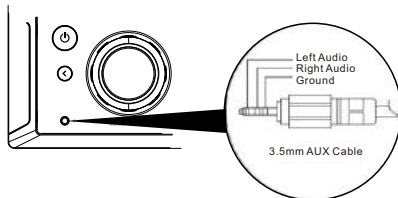

Coaxial

When a portable audio device is connected to the unit, press the **AUX** button repeatedly until COAXIAL mode is selectable, then press **ENTER** (34) to enter the COAXIAL mode. To connect a portable audio device, connect the coaxial cable output from your portable CD / MP3 or other media player into the Coaxial Jack on the left of the unit.

Refer to "Multi source mode" on page 11 for operating instructions.

Optical

When a portable audio device is connected to the unit, press the **AUX** button repeatedly until Optical mode is selectable, then press **ENTER** (34) to enter the Optical mode. To connect a portable audio device, connect the optical cable output from your portable CD / MP3 or other media player into the Optical Jack on the left of the unit.

Refer to "Multi source mode" on page 11 for operating instructions.

HDMI IN

When a portable audio device is connected to the unit, press the **AUX** button repeatedly until HDMI IN mode is selectable, then press **ENTER** (34) to enter the HDMI IN mode. To connect a portable device with HDMI output ports, connect the HDMI cable from your portable device into the HDMI IN interface (5) on the front left of the JWM90A.

Refer to "Multi source mode" on page 11 for operating instructions.

HDMI devices**

When a portable audio device is connected to the unit, press the **AUX** button repeatedly until HDMI IN mode is selectable, then press **ENTER** (34) to enter the HDMI IN mode. To connect a portable device with HDMI output ports, connect the HDMI cable from your portable device into the HDMI IN interface (5) on the front left of the JWM90A.

Refer to "Multi source mode" on page 11 for operating instructions.

Amazon Fire Stick streaming device:

<http://www.amazon.com> *

Roku HDMI streaming device:

<http://www.roku.com/products/compare> *

Warning: Using the front USB input for powering your HDMI streaming stick is not recommended. We suggest using a wall adapter power supply to power your HDMI streaming stick.

Notes:

* Web links can change over time; if the above links do not function go to your device manufacturer's or smartphone service provider's web site for more information.

** These devices require connection to Wi-Fi or a hotspot in order to stream video content from providers such as Netflix, Hulu, Crackle, etc..

Caution: Streaming video can consume large amounts of data when a smartphone is used as a hotspot. Data rates may apply. See your mobile phone service provider for details.

USB Interface Connector

You can connect a USB device directly to **USB** interface (11) on the front of the JWM90A for playback of compatible files. Press the **USB** button (22) to switch to USB mode from another source for active zone.

NOTE: *USB will not support Apple device playback. The USB input supplies up to 1A of charging current.*

Liquid Crystal Display (LCD)

The current activated functions and time are shown on the LCD panel (8).

Dimming control

- 1. Press the DIM button (6) on the front panel to turn the dimmer On (selected brightness level) and press again to turn the dimmer Off (maximum brightness level).
- 2. Press & Hold the DIM button (6) to access DIMMER LEVEL menu.
- 3. Rotate the volume knob clockwise to increase or counter-clockwise to decrease the brightness of button and LCD backlight from "BRIGHTNESS 0" to "BRIGHTNESS 8". "BRIGHTNESS 0" indicates the LCD backlight is turned off.
- 4. Press the BACK button (2) to confirm your selection and exit menu.

NOTE: *When subjected to cold temperatures for an extended period of time, LCD panels will take longer to illuminate and the display visibility may slightly decrease. Optimal LCD operation will return to normal when the temperature increases to a normal range.*

Clock Setup

Press the **Clock** button (27) to access clock set up mode. The hour clock digit will flash. Rotate the **VOL/ENTER** knob clockwise or counter-clockwise to adjust the hour. Press the **ENTER** knob to access the minute adjustment. Press the **ENTER** knob again to save the clock. If the new time is not confirmed by pressing the **ENTER** button, the unit will automatically exit the clock setting menu after 10 seconds of inactivity and the new time will be set.

Sleep Mode Setup

The sleep timer will automatically turn off the JWM90A in designated number of minutes. To set the Sleep Time, press the **SLEEP** button (28) and the sleep time will appear in the display with the number representing the minutes (SLEEP 15). Press the **SLEEP** buttons (28) or rotate the **VOL/ENTER** knob clockwise or counter-clockwise to change the sleep time from SLEEP OFF, 15, 30, 45 or 60 minutes.

Alarm Setup

The alarm will turn on the unit from standby at a specific set time. Last mode will play. Press the **ALARM** button (29) to turn alarm function on or off. Press and hold the **ALARM** button to access alarm setting, the hour clock digit will flash. Rotate the **VOL/ENTER** knob clockwise or counter-clockwise to adjust the hour. Press the **ENTER** knob to access the minute adjustment. Press the **ENTER** knob again to save the alarm time and return to ALARM ON/OFF setting.

Reset

The reset button should be activated for the following reasons:

- Initial installation of the unit when all wiring is completed
- Function buttons do not operate
- Error symbol on the display

Use a ball point pen or similar object to press the **RESET** button (4). This may be necessary should the unit display an error code.

HDMI ARC

Connect HDMI cable to JENSEN TV with ARC function and JWM90A radio head unit. If the set up and operation is correct, the TV audio will come out from the speaker of the head unit after switching to HDMI ARC mode.



DESIGNED TO MOVE [YOU]

JWM90A

No	Device Status		User Operation	Operation Results		Remarks
	Head Unit	TV		Head Unit	TV	
1	Power ON (HDMI ARC)	Power ON	Power OFF TV	Power OFF	Power OFF	
2	Power OFF	Power OFF	Power ON TV	Power OFF	Power ON	
3	Power OFF (Last mode is HDMI ARC before Power OFF)	Power OFF	Power ON Head Unit	Power ON (HDMI ARC)	Power ON (Last mode before power off)	
4	Power OFF (Last mode is HDMI ARC before Power OFF)	TV, AV, USB, HDMI (non HDMI ARC)	Power ON Head Unit	Audio Out	No Audio Out	If the TV can play the device automatically, there will be TV audio out. Otherwise, switch to USB mode to play the device.
5	Power ON (HDMI ARC)	TV, AV, USB, HDMI (non HDMI ARC)	Power OFF Head Unit	No Audio Out	Audio Out	
6	DISC Mode	Display disc content	Switch TV to another mode (such as TV, AV, USB, non-HDMI ARC mode)	Switch to HDMI ARC Mode and Audio out from Head unit in HDMI ARC mode	No Audio Out	
7	HDMI ARC Mode	TV, AV, USB, HDMI (non HDMI ARC)	Switch Head unit to another mode (Such as FM, Bluetooth, DVD or AUX)	No Audio out (No HDMI ARC Audio Out)	Audio Out	TV Speaker ON
8	HDMI ARC Mode	TV, AV, USB, HDMI (non HDMI ARC)	TV Audio Receiver OFF	No Audio Out	Audio Out	TV Speaker ON
			TV Audio Receiver ON	Audio Out	No Audio Out	TV Speaker ON
9	HDMI ARC Mode	TV, AV, USB, HDMI (non HDMI ARC)	TV CEC Mode OFF	No Audio Out	Audio Out	TV Speaker ON
			TV CEC Mode ON Audio Receiver ON	Audio Out	No Audio Out	TV Speaker ON

Multi-source Setup and Operation

The jControl App is suggested for easier control and navigation of the multi-source feature. Refer to page 19 for more information about the jControl App.

1. Press the **ZONES** button (31) to enter the zone menu.
2. While in the zone menu, press **ZONES** button (31), or the [**<<** or **>>**] buttons (20, 19) repeatedly to navigate through the zones menu settings (ZONE A mode, ZONE A volume adjustment, ZONE B mode, ZONE B volume adjustment, ZONE C mode and ZONE C volume adjustment).
3. While in zone mode selection, rotate the **VOL/ENTER** knob to cycle through the available modes. Available modes are AM, FM, BLUETOOTH, FRONT AUXILIARY, REAR AUXILIARY, COAXIAL OPTICAL, DISC and USB. Or press the **AM**, **FM**, **DISC**, **BT**, **USB** or **AUX** button (26, 25, 24, 23, 22, and 21) to choose the desired mode for each zone mode setting. Press the **AUX** button (21) repeatedly to cycle through the FRONT AUXILIARY, REAR AUXILIARY, COAXIAL, OPTICAL, HDMI ARC and HDMI IN.
4. Press **ENTER** knob (4) to confirm the mode selection.

NOTE: If Zone A is in AM, FM, BT, FRONT AUX or REAR AUX mode, the multi-source function cannot be activated. Zone B and Zone C source mode will follow Zone A.

If Zone A is in DISC, USB, COAXIAL, OPTICAL, HDMI IN or HDMI ARC mode, the following sources are selectable for Zone B: AM, FM, BT, FRONT AUX, REAR AUX as well as the current active Zone A source. Zone C source mode will follow Zone B.

If Zone A and Zone B are both set to DISC, USB, COAXIAL, OPTICAL, HDMI IN, or HDMI ARC mode, the following sources are selectable for Zone C: AM, FM, BT, FRONT AUX, REAR AUX as well as the current active Zone A/B source.

NOTE: Refer to the Multi-source Zone Table for all possible Multi-source states.

Multi-source Zone Table		
Zone A	Zone B	Zone C
AM, FM, BT, FRONT AUX or REAR AUX	Same source as Zone A	Same source as Zone A
DISC, USB, COAXIAL, OPTICAL, HDMI IN or HDMI ARC	AM, FM, BT, FRONT AUX, REAR AUX, or same source as Zone A	Same source as Zone B (AM, FM, BT, FRONT AUX, REAR AUX)
DISC, USB, COAXIAL, OPTICAL, HDMI IN or HDMI ARC	Same source as Zone A	AM, FM, BT, FRONT AUX, REAR AUX, or same source as Zone A/B

TUNER OPERATION

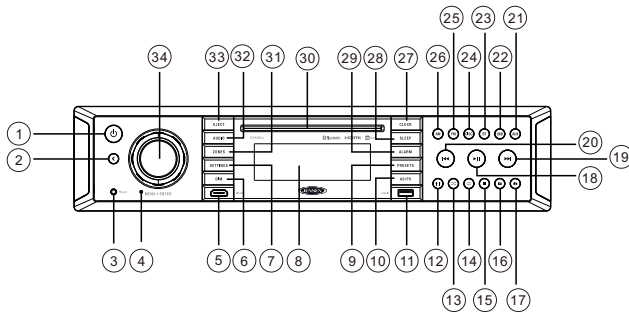

Select a Band

Press **AM** button (26) to select the AM band or press **FM** button (25) to select the FM band. Refer to "Multi source zone mode" on page 9 for detail of operating instructions

Manual Tuning

Press the **>>|<<** buttons (19, 20) to seek stations up/down step by step.

Auto Seek Tuning

Press and hold the **>>|** or **|<<** buttons (19, 20) to automatically seek to the next or previous strong station.

Preset Stations Menu

Store a Station

While in AM or FM mode,

1. Press the **PRESETS** button (9) to access the preset menu.
2. Press **|<<** or **>>|** buttons (19, 20) or rotate the **VOL/ENTER** knob to select the preset location to store.
3. Press and Hold the **ENTER** knob to store the current station at that preset location.
4. Press the **BACK** button (2) to exit presets menu.

Recall preset stations

1. Press the **PRESETS** button (9) to access the preset menu.
2. Press **|<<** or **>>|** buttons (19, 20) or rotate the **VOL/ENTER** knob to navigate the 12 and 18 preset stations for AM or FM respectively.
3. Press the **ENTER** knob to confirm the selection.
4. Press the **BACK** button (2) to exit preset menu

The LCD will display the current station on 1st line and the preset station selection on the 2nd line in presets menu.

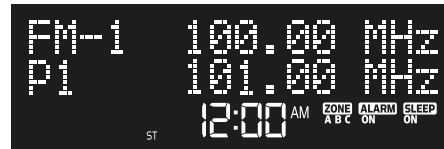

Automatically Store / Preset Scan (AS/PS)

Automatically Store

Select AM or FM band. Press and hold the **AS/PS** button (10) for more than 3 seconds and the unit will automatically scan for and store 12 or 18 strongest stations for AM or FM respectively. To stop this function before the automatic storing is complete, press AS/PS button again.

Preset Scan

Select a band. Press **AS/PS** button to scan stations stored in the current band. The unit will pause for 10 seconds at each preset station. Press **AS/PS** again to stop scanning when the desired station is reached.

DISC OPERATION

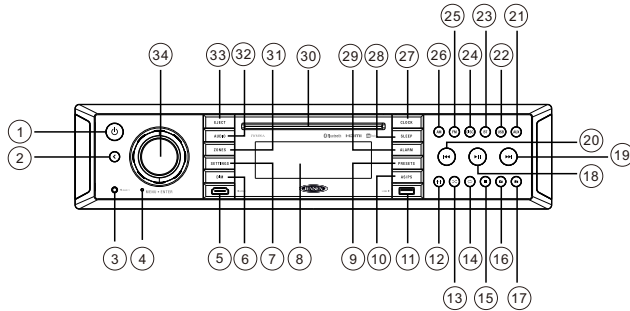

CD OPERATION

Inserting a CD

Inserting a CD label-side up into the disc slot (30) and the disc will begin to play automatically. Refer to "Multi source zone mode" on page 11 for detail of operating instructions

Ejecting a CD

Press the **EJECT** button (33) to stop CD play and eject the CD

Pausing Playback

Press the **II** button (18) to suspend or resume disc play.

Stop Playback

Press the **■** button (15) to suspend disc play, and "PRE STOP" will appear in the display. Press the **II** button (18) to resume disc play from the last position. Press **■** button twice and "STOP" will appear on the display.

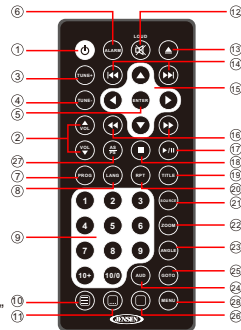

Track Select

Press the **>>|** or **|<<<** button (19, 20) to advance to the previous or next track on the CD. The selected track number will appear on the display. Press and hold the **>>|** or **|<<<** button for more than three seconds to fast forward or fast reverse through the disc. CD play starts when the play/pause button is pressed.

Fast Forward/Reverse

Press and hold the **>>|** or **|<<<** button (19, 20) or press the **>>** or **<<** buttons on the remote control (14) once for FORWARD X2. Press and hold additional times for FORWARD X4, X8, X20 or PLAY. Press the **II** button on the control panel (18) or remote control (17) to end fast forward or reverse and resume normal playback.

Intro Scan (INT)

Press the **INT** button (12) during disc play to play the first 10 seconds of each track on the current disc. Press **INT** again to end the scan and play the selected track.

Random Shuffle (RDM)

Press the **RDM** button (13) to play all tracks on a CD in random, shuffled order (RANDOM ON). Press **RDM** again to stop random play (RANDOM OFF).

Repeat (RPT)

Press the **RPT** button (14) during disc play to access the repeat function. Press again to continuously repeat the selected track (RPT ONE). Press a third time to repeat all tracks (RPT ALL). Press once more time to stop repeat function (RPT OFF).

Programmed Playback

1. Press the **PROG** button (7) on the remote control to access the programmed playback screen.
2. Use the **4** or **▲** cursor buttons (15) on the remote control to access the fields on the "PROG" screen.
3. Use the number buttons on the remote control to enter a track number in each field.
4. Press the **▶/||** button (17) on the remote control or highlight "PLAY" on screen and then press the **ENTER** button (5) to begin playback in the numbered order indicated to delete the list, highlight "CLEAR" and then press **ENTER**. Press **PROG** to exit the programmed playback screen.

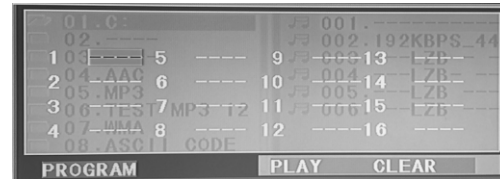

Remote Control Direct Track Entry

To select a track directly, use the number pad on the remote control (10). For single digit entries, press the corresponding number for two digit entries. Press the **10+** button followed by the last digit (i.e., for track 16, press 10+ and then 6).

GOTO Direct Track/Chapter Access

Use the GOTO function to access a track (chapter) directly.
 1. Press the **GOTO** button (25) on the remote control. The On Screen Display information will appear with the track number highlighted.
 2. Use the number keys on the remote control to enter the 3-digit track number directly (i.e. for track 10, enter "010")
 3. Press the **ENTER** button (5) to confirm and begin playback.

CD Playback Information

The following information is displayed at the top of the screen during CD playback:



TRK ###/### – "1/18" indicates the first of 18 tracks on the CD is currently playing.

 "X" indicates repeat play is OFF, "1" indicates repeat track, and "A" indicates repeat disc.

Press the  button on the remote control (26) repeatedly to view the following information for elapsed/remaining playing time:

 00:02:18 –total elapsed playing time of current track;
 C –00 :34 :37 –remaining playing time of current track;
 T 00:02:18 –total elapsed playing time for current disc;
 T –00 :34 :37 –remaining playing time for current disc.

DVD/VCD OPERATION

Inserting a Disc

Insert a disc label-side up into the disc slot (30) and the disc will begin to play.

NOTE: Press the **DISC** or **USB** button (24, 22) to alternate between the USB and DVD source.

Ejecting a DVD

Press the **EJECT** button (33) to stop DVD play and eject the DVD.

Pausing Playback

Press the **II** button (18) to suspend or resume disc play.

Stop Playback

Press the **■** button (15) to suspend disc play, and "PRE STOP" will appear in the display.

Press the **II** button (18) to resume disc play from the last position. Press **■** button twice and "STOP" will appear on the display.

Track Select

Press the **>>|** or **|<<<** button (19, 20) to advance to the next or previous track on the disc. The selected track number will appear on the display.

Language Selection

While playing a DVD, press the FOLDER UP button to change the DVD audio language.

Fast Forward/Reverse

Press and hold the **>>|** or **|<<<** button (20, 19) or press the **>>|** or **|<<<** buttons on the remote control (14) once for FAST FORWARD/REVERSE X 2. Press and hold again for FAST FORWARD/REVERSE X 4, X 8, X 20 or PLAY. Press the **II** button on the control panel or remote control (17) to end fast forward or reverse and resume normal playback.

Repeat Chapter/Title

Press the **RPT** button (20) on the remote control multiple times during playback to select from the following repeat play options:

- VCD: RER 1 (track), RER ALL (disc), RPT OFF
- DVD: RER Chapter, RER Title, RPT All, RPT OFF

Playback Control (VCD Only)

Playback Control (VCD Only)

Press the **MENU** button (28) on the remote control to turn Playback Control on/off when this feature is available on your VCD.

Programmed Playback

1. Press the **PROG** button (7) on the remote control to access the programmed playback screen.



- Use the ◀▶ or ▲▼ cursor buttons (15) on the remote control to access the fields on the "PROG" screen.
- Use the number buttons on the remote control to enter a track number in each field.
- Press the ▶/|| button (17) on the remote control or highlight "PLAY" on screen and then press the ENTER button (5) to begin playback in the numbered order indicated to delete the list, highlight "CLEAR" and then press ENTER. Press PROG to exit the programmed playback screen .

DVD Playback Features

The following remote control features, along with many others, are available during DVD playback (see "Remote Control Operation" on page 20 & 21 for complete functionality):

- LANG: Press to choose an alternate audio language, if available.
- SUBTITLE: Press to select an alternate subtitle language, if available.
- ANGLE: Press to select an alternate viewing angle, if available.
- ZOOM: Press to zoom the picture at ZOOM 2, ZOOM 3, ZOOM 4, ZOOM 1/2, ZOOM 1/3 or ZOOM 1/4, or select OFF to return to normal view.

NOTE: Feature availability is dependent upon DVD embedded information.

Playback Information

During DVD and VCD playback, press the button (26) on the remote control to display playback information on the screen, including the media playing and current playback time.

Continue pressing the button to display additional information, as indicated below.

DVD Playback Information

The following information is displayed at the top of the screen during DVD playback:

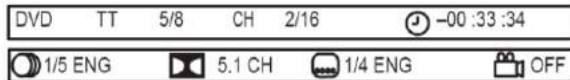

TT 5/8 – "5 / 8" indicates the fifth of 8 titles on the DVD is currently playing.
 CH 2/16 – "2 / 16" indicates that the second of 16 chapters on the DVD is currently playing.

Press repeatedly to view the following information: for elapsed/remaining playing time:

00:02:18 –total elapsed playing time of the current track;

C –00:34:37 –remaining playing time of the current track;

T 00:02:18 –total elapsed playing time for disc;

T –00:34:37 –remaining playing time for disc..

○ 1/5 ENG –English is the selected audio language out of 5 possible choices;

⊞ 5.1 CH –The current language is recorded in 5.1 surround sound;

○ 1/4 ENG –English is the selected subtitle language out of 4 possible choices;

⊞ OFF –There are no alternate angles recorded for this scene.

Remote Control Direct Track Entry

To select a track directly, use the number pad on the remote control (10).

For single digit entries, press the corresponding number for two digit entries. Press the **10+** button followed by the last digit (i.e., for track 16, press **10+** and then **6**).

GOTO Direct Track/Chapter Access

Use the **GOTO** function to access a track (chapter) directly.

1. Press the **GOTO** button (25) on the remote control. The On Screen Display information will appear with the track number highlighted.

2. Use the number keys on the remote control to enter the 3-digit track number directly (i.e. for track 10, enter "010").

3. Press the **ENTER** button to confirm and begin playback.

MP3/USB OPERATION

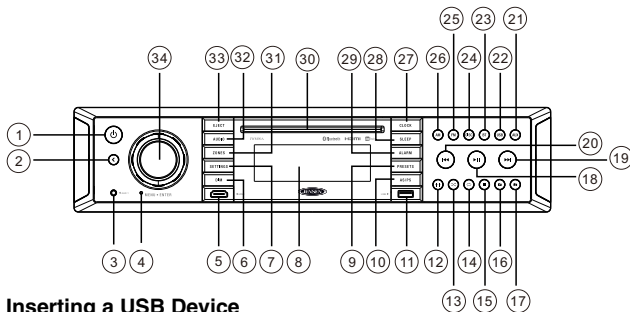

Inserting a USB Device

The **USB** connector (11) is at the bottom right corner of the panel. Insert a USB device and press the USB button to select USB mode. The LCD will display "LOADING" and "USB" while files are initially loaded. When USB is removed, it will automatically back to the previous mode before the USB is connected. During other playback mode, when USB is connected, press **USB** button to enter USB playback mode directly.

NOTE: MP4 video format is not supported.

MP3 Specifications

Notes on MP3 Playback:

- Any directory that does not include an MP3 file is skipped
- Maximum number of folders: 512 (including skipped directories)
- Maximum number of folder levels: 12
- Maximum number of MP3 files: 999
- Maximum number of characters for MP3 files name and folder name: 32
- Maximum number of Characters of ID3 Tag:

- ID3 Tag version 1.0: 32
- ID3 Tag version 2.x: 32

MP3 Monitor Display

After loading an MP3 disc or USB device, the following screen will appear on your output monitor

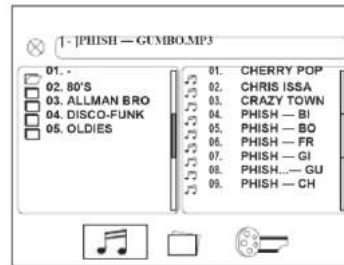

Select one of these icons to access the corresponding media on your disc or USB device. If the media type is not present, the icon will not be selectable.



Audio



Photos



Video

Play/Pause

Press the **▶|◀** button (18) to suspend or resume disc play.

Track Select

When playback is stopped, press the **>>|** or **|<<<** button (19, 20) or **>>|** or **|<<<** (14) button on the remote control to advance to the next or previous track in the current folder. The selected track number will appear on the display.

Folder Up/Down

Press the **FOLDER UP** (17) to access a higher folder level. Press the **FOLDER DN** (16) to access a lower folder level.

Intro Scan (INT)

Press the **INT** button (12) during disc play to play the first 10 seconds of each track on the current disc. Press **INT** again to end the scan and play the selected track.

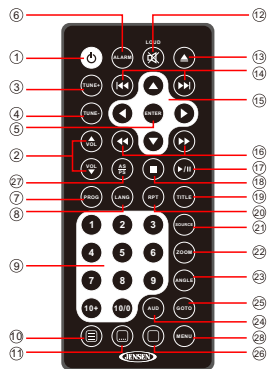

Repeat (RPT)

Press the  button (14) on the control panel or the **RPT** button (20) on the remote control multiple times during playback to select from the following repeat play options: RPT 1 (track), RPT DIR (folder), RPT ALL (disc), OFF.

Random Shuffle (RDM)

Press the  button (13) during song playback to play all files in random, shuffled order. Press **RDM** again to stop random play.

Fast Forward/Reverse

Press and hold the >>| or |<<< buttons or press the >> or <<< buttons on the remote control (16) once for FORWARD X 2. Press and hold additional times for FORWARD X 4, X 8, X 20 or PLAY.

Press the ►|| button on the control panel (18) or remote control (17) to end fast forward or reverse and resume normal playback.

Programmed Playback

1. Press the **PROG** button (7) on the remote control to access the programmed playback screen.
2. Use the ◀▶ or ▲▼ cursor buttons (15) on the remote control to access the fields on the "PROG" screen.
3. Use the number buttons on the remote control to enter a track number in each field.
4. Press the ►|| button (17) on the remote control or highlight "PLAY" on screen and then press the **ENTER** button (5) to begin playback in the numbered order indicated. To delete the list, highlight "CLEAR" and then press **ENTER**. Press **PROG** to exit the programmed playback screen."

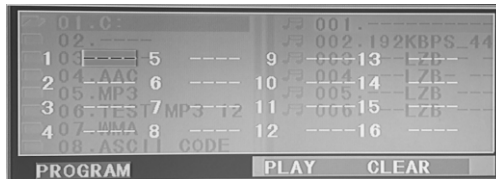

Remote Control Direct Track Entry

To select a track directly, use the number pad on the remote control (10). For single digit entries, press the corresponding number for two digit entries. Press the **10+** button followed by the last digit (i.e., for track 16, press **10+** and then **6**).

GOTO Direct Track/Chapter Access

Use the **GOTO** function to access a track (chapter) directly.

1. Press the **GOTO** button (25) on the remote control. The On Screen Display information will appear with the track number highlighted.
2. Use the number keys on the remote control to enter the 3-digit track number directly (i.e. for track 10, enter "010")
Press the **ENTER** button (5) to confirm and begin playback.

BLUETOOTH OPERATION

The JWM90A includes built-in Bluetooth technology that allows you to connect this head unit to Bluetooth devices for streaming audio playback.

About Bluetooth Technology

Bluetooth wireless technology is a short-range wireless radio protocol. Operating in the 2.4 GHz range, it transmits audio and data at speeds up to 2.1 Mbit/s over a range of up to 10 meters.

Bluetooth On/OFF

Bluetooth mode is turned ON by default. Bluetooth can be turned OFF to reduce the standby current draw of the JWM90A. Press the **SETTINGS** button (7) to enter menu adjustment mode. Repeatedly press the >>| or |<< buttons (20, 19) or **SETTINGS** button to access BLUETOOTH ON/OFF. Rotate the **VOL/ENTER** knob to select ON or OFF.

Bluetooth Menu Options

NOTE: Please note that some Bluetooth menu options are only available while the unit is in Bluetooth Audio mode.

Press the **SETTING** button (7) to enter menu adjustment mode. Repeatedly press the >>| or |<< buttons (19, 20) or **SETTING** button to access the "Bluetooth Device" menu. The following menu options are available when the unit is in Bluetooth mode.

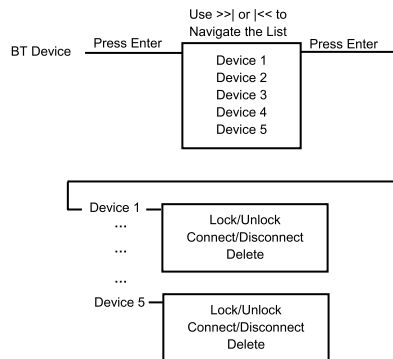

- **BLUETOOTH PAIR:** Press the **ENTER** knob to make the JWM90A available to pair with a Bluetooth enabled device.
- **BLUETOOTH DEVICES:** Press the **ENTER** knob button to view a list of previously paired mobile devices models. Press the >>| or |<< buttons to view devices from the list. You cannot delete a device that is actively connected. Press the **ENTER** knob button to select the device. Press the >>| or |<< buttons to choose Locked/Unlocked, Connect/Disconnect or Delete for this device.
- **CONNECT/DISCONNECT:** To disconnect a paired device, press the **ENTER** knob button to temporarily remove the BT link. The link can be re-established through your phone menu by selecting the JWM90A for connection.
- **LOCKED/UNLOCKED:** The JWM90A can store up to 5 devices for BT connection. The devices are stored in FIFO (First In First Out) order. To prevent a device from being bumped from the list when more than 5 devices are used, you must lock the device. To Lock/Unlock a device, press the **ENTER** knob button.
- **DELETE:** To delete a device from the list, Press the **ENTER** knob button.

Pairing a Bluetooth Device

Before you begin, consult the owner's manual for the Bluetooth device you want to pair with the JWM90A.

Make sure the device you intend to pair with is on and ready to pair.

1. Press **BT** button (23) to enter Bluetooth mode.
2. Press & Hold **BT** button to start Bluetooth pairing process.
The JWM90A will display "PAIRING" and will be available to pair for 120 seconds.
3. In your device Bluetooth settings, select "JWM90A" to connect.

Answering a Call

When answering a call using the connected phone, BT AUDIO will pause. After hanging up from the call, BT AUDIO will automatically resume on some phones. It may be necessary to press the play button to resume BT AUDIO.

Bluetooth Audio (A2DP)

The A2DP music is available for Bluetooth enabled phones when the phone is connected. To access Bluetooth mode and play songs stored in your phone, press the **BT** button (23) to enter the Bluetooth mode.

Selecting Tracks

During playback, press the >>| or |<< button (19, 20) to play the previous or next track.



DESIGNED TO MOVE [YOU]

JWM90A

Pausing Playback

During playback, press the ►|| button (18) to pause the Bluetooth audio playback. "BT PAUSE" will appear on the LCD. Press ►|| button again to resume playback.

If you change to another mode, the mobile device audio will pause. Press the BT button (23) to return to Bluetooth mode and resume mobile phone audio playback.

NOTE: If a Bluetooth device is disconnected due to the power being turned off or if the device is disconnected inadvertently, the unit will automatically search for the matching BT mobile phone when the power is restored.

APP OPERATION

JENSEN® Specialty Controller is the ultimate wireless remote control for your JENSEN stereo system. Store away your old remotes and enjoy the convenience of all the primary functions of your JENSEN stereo right from your phone or tablet by transforming your mobile device into a functional stereo remote control!

Features

This app controls all of the primary functions of your stereo features including:

- Power on/off
- Volume and mute
- CD/DVD player
- AM/FM radio tuner: access station, recall, store presets, switch songs
- Bluetooth® streaming audio
- File structure visibility, track selection, track audible scan up and down via USB
- Auxiliary audio input control –auxiliary analog 1 & 2, auxiliary digital coaxial, auxiliary digital optical
- Speaker selection A, B and/or C
- Audio menu controls- bass, treble, balance, fader, equalizer, volume and speaker selection settings
- Clock with sleep time and alarm
- Visual display feedback so you can see artist title and album on your mobile screen

Connecting and using jControl app

After downloading and installing jControl app on your device, pair your device to the JWM90A as stated above for Bluetooth pairing.

When jControl is installed on Android operating system, close the app before Bluetooth pairing, otherwise there may be errors on Bluetooth connection.



DESIGNED TO MOVE [YOU]

JWM90A

REMOTE CONTROL OPERATION

REF	DESCRIPTION	TUNER	BLUETOOTH	CD/MP3/USB	DVD
1	Power	Turn radio on/standby mode.	Turn radio on/standby mode.	Turn radio on/standby mode.	Turn radio on/standby mode.
2	VOL +/-	Adjust volume up/down. Press for Audio Control Setup menu.	Adjust volume up/down. Press for Audio Control Setup menu.	Adjust volume up/down. Press for Audio Control Setup menu.	Adjust volume up/down. Press for Audio Control Setup menu.
3	TUNE +	Tune to higher station			
4	TUNE -	Tune to lower station			
5	ENTER			Confirm menu selection	Confirm menu selection
6	ALARM	Turn the alarm feature on/off.	Turn the alarm feature on/off.	Turn the alarm feature on/off.	Turn the alarm feature on/off.
7	PROG			Display Program Play Menu	Display Program Play Menu
8	LANG			Display MONO/L, MONO/R or STEREO.	Select alternate audio language, if available.
9	Numeric Keyboard	Use 1-6 to access preset stations.		Enter track number to access track directly. For track Number > 10, use 10+ followed by second digit.	Enter track number to access track directly. For track Number > 10, use 10+ followed by second digit.
10	Setup			View SETUP menu.	View SETUP menu.
11	Subtitle				Choose subtitle language, if available.
12	Mute/LOUD	Silence Audio output. Press and hold to turn LOUDNESS feature on/off.	Silence Audio output. Press and hold to turn LOUDNESS feature on/off.	Silence Audio output. Press and hold to turn LOUDNESS feature on/off.	Silence Audio output. Press and hold to turn LOUDNESS feature on/off.
13	Eject	Eject Disc.	Eject Disc.	Eject Disc.	Eject Disc.
14	Previous/Next		Select next/previous track.	Select next/previous track.	Select next/previous track.
15	Directional Buttons			Move to desired menu item and then press ENTER to confirm.	Use with DVD menu to move to desired menu item and then press ENTER to confirm
16	Fast Reverse/ Forward			Fast Forward 2X, 4X, 8X, 20X. Fast Reverse 2X, 4X, 8X, 20X.	Fast Forward 2X, 4X, 8X, 20X. Fast Reverse 2X, 4X, 8X, 20X.
17	Play/Pause Stop		Pause/resume playback	Pause/resume playback	Pause/resume playback
18	Stop			Stop playback.	Stop playback.

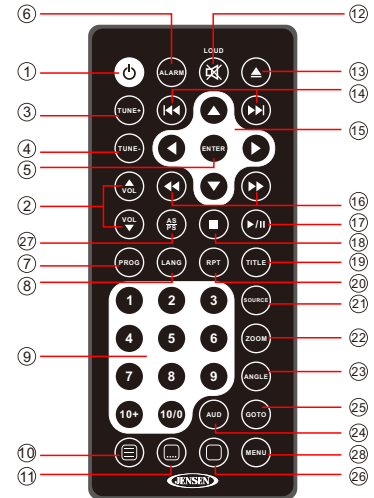



DESIGNED TO MOVE [YOU]

JWM90A

19	TITLE				Press to view title menu. Use directional arrows and play button to play selected title. May not be supported by all discs.
20	RPT			Repeat track	Repeat chapter
21	SOURCE	Select source for playback	Select source for playback	Select source for playback	Select source for playback
22	ZOOM				Zoom picture or press repeatedly to change magnification level.
23	ANGLE				Select alternate viewing angle, if available.
24	AUD	Access Audio Menu options.	Access Audio Menu options.	Access Audio Menu options.	Access Audio Menu options.
25	GOTO			Select exact time, track or chapter for playback.	Select exact time, track or chapter for playback.
26	Display			Display current playback information on the screen.	Display current playback information on the screen.
27	AS/PS	Browse preset stations (10 sec. interval). Press and hold to scan/store stations.			
28	MENU	Access system MENU.	Access system MENU.	Access system MENU.	Press to access system MENU. Press and hold to access DVD MENU.

DVD SETUP MENU

Press the (setup) button (10) on the remote control to access the SETUP menu and adjust system settings for the following categories:

- System Setup
- Language Setup
- Audio Setup
- Video Setup
- Digital Setup

While in the setup menu, use your directional arrows to select and change settings. The “up” and “down” arrows highlight the options, and the “right” and “left” arrows will change the setting for the highlighted option.

System Setup

The System Setup menu controls the following features:

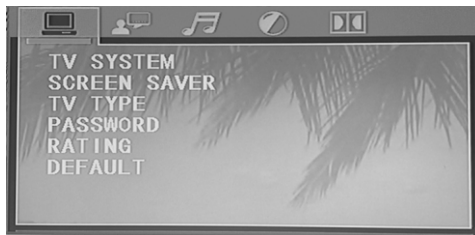

- **TV System:** This item is used to select a TV signal system to match your TV set. Select one of the following options: AUTO, NTSC or PAL.
- **Screen Saver:** Turn Screen Saver feature On/Off.
- **TV Type:** Select one of the following picture formats: 4:3PS, 4:3 LB or 16:9. 4:3 is a letterbox selection, and 16:9 is wide screen.
- **Password:** This item allows the selection of a new four-digit code to use for security purposes.
- **Rating:** Select the parental control level for all DVD play. The security password is required to make changes to this feature.
- **Default:** Use this item to restore default settings at any time.

Language Setup

The Language Setup menu controls the following features:

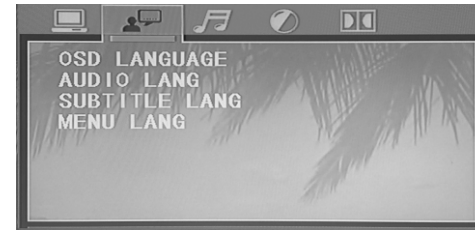

- **On-Screen Display (OSD) Language:** Set the OSD language to one of the following: English, German, Spanish, French.
- **Audio Language:** Set the audio language to one of the following: English, Japanese, French, Spanish, Portuguese, Latin or German.
- **Subtitle Language:** Set the subtitle language to one of the following: English, French, Spanish, Portuguese, German or OFF.
- **Menu Language:** Set the menu language to one of the following: English, French, Spanish, Portuguese, German.

Audio Setup

The Audio Setup menu controls the following features:



- **Audio Out:** This item defines the digital output format.
- **Key:** This item changes the audio output key.

Video Setup

The Video Setup menu controls the following features:



- Brightness
- Contrast
- Hue
- Saturation
- Sharpness

Digital Setup

The Speaker Setup menu controls the following features:



- OP Mode: Select LINE OUT or RF REMOD.
- Dynamic Range: Select FULL, 6/8, 4/8, 2/8 or OFF.
- Dual Mono: Select STEREO, MONO/L, MONO/R or MIX MONO.



DESIGNED TO MOVE [YOU]

CARE AND MAINTENANCE

- Keep the product dry. If it does get wet, wipe it dry immediately. Liquids might contain minerals that can corrode the electronic circuits.
- Keep the product away from dust and dirt, which can cause premature wear of parts.
- Handle the product gently and carefully. Dropping it can damage circuit boards and cases, and can cause the product to work improperly.
- Wipe the product with a dampened cloth occasionally to keep it looking new. Do not use harsh chemicals, cleaning solvents, or strong detergents to clean the product.
- Use and store the product only in normal temperature environments. High temperature can shorten the life of electronic devices, damage batteries, and distort or melt plastic parts.

Ignition

The most common source of noise in reception is the ignition system. This is a result of the radio being placed close to the ignition system (engine). This type of noise can be easily detected because it will vary in intensity of pitch with the speed of the engine.

Usually, the ignition noise can be suppressed considerably by using a radio suppression type high voltage ignition wire and suppressor resistor in the ignition system. (Most vessels employ this wire and resistor but it may be necessary to check them for correct operation.) Another method of suppression is the use of additional noise suppressors. These can be obtained from most CB/A radio or electronic supply shops.

Interference

Radio reception in a moving environment is very different from reception in a stationary environment (home). It is very important to understand the difference. AM reception will deteriorate when passing under a bridge or when passing under high voltage lines. Although AM is subject to environmental noise, it has the ability to receive at great distance. This is because broadcasting signals follow the curvature of the earth and are reflected back by the upper atmosphere.

TROUBLESHOOTING

Symptom	Solution
Radio will not turn ON or No front panel operation	Try the reset button.
	Check fuse.
	Check 12V+ on accessory wire to radio (RED wire)
	Check Ground.
Radio turns ON, but no sound	Verify Volume, Fader/Balance, Mute controls are set correctly (see owner's manual).
	Try the reset button.
	Verify proper speaker selection.
	Verify proper speaker connections.
	Check for shorts or open circuits on speaker wires. <ul style="list-style-type: none"> • If short on "A" channel, "B & C" channels will continue to function. • If short on "B and/or C" channels, "A" channel will continue to function.
Display is blank	Turn unit off and on to reset the display.
Bluetooth Device will not connect/pair	Make sure no devices are already connected. Disconnect any connected devices.
	On your smart device, turn the Bluetooth off and on and try again.
CD/DVD does not play correctly	Make sure unit has power and no other CD/DVD is currently inside.
	Make sure the disc is a compatible disc.
CD/DVD does not play correctly	Check to make sure disc is inserted correctly.
	Verify disc is free from dirt, scratches, etc.
	Check with factory Cds.
	Check factory original CDs for compatibility warnings (due to various copy-protection, multimedia content, etc.).
No AM or FM reception	Verify you are tuned to a valid station.
	Check your antenna connection on rear of stereo.
	Try a different antenna
DVD plays sound but no video	Make sure the HDMI cable is routed from the HDMI output to the input on the television.
Unit does not respond to Remote Control	Verify that you have a clear line of sight for the IR signal.
	Check the batteries.



DESIGNED TO MOVE [YOU]

SPECIFICATIONS

FM Tuner

Frequency Coverage (USA)	87.5 to 107.9 MHz
Frequency Coverage (Europe)	87.5 to 108 MHz
Sensitivity	<4 μ V
Stereo Separation@1 kHz	>25 dB

AM Tuner

Frequency Range (USA)	530-1710 kHz
Frequency Range (Europe)	522-1620 kHz
Sensitivity (S/N=20dB)	<63 μ V

Amplifier

Output Power	20W x 8
Output Impedance	Compatible with 4-8 Ω ohms speakers, 4 ohm load minimum

DVD

Frequency Response	20-20,000 Hz
Channel Separation	50 dB
S/N Ratio	65 dB
Distortion	0.5%

General

Power Supply Requirements	DC 12 Volts, Negative Ground
Operating Voltage	11-16 VDC
Overall Dimensions	432mm (W) x 180mm (D) x 95mm (H)
.....	17. 1" (W) x 7.09" (D) x3. 74" (H)
Mounting Dimensions	278mm (W) x 160mm (D) x72. 5mm (H)
.....	10. 9" (W) x 6.3" (D) x 2. 85" (H)
Weight	2. 04 KG
.....	4. 5 lbs

FCC Notes

NOTE: This equipment has been tested and found to comply with the limits for a Class B digital device, pursuant to Part 15 of the FCC Rules. These limits are designed to provide reasonable protection against harmful interference in a residential installation. This equipment generates uses and can radiate radio frequency energy and, if not installed and used in accordance with the instructions, may cause harmful interference to radio communications. However, there is no guarantee that interference will not occur in a particular installation. If this equipment dose cause harmful interference to radio or television reception, which can be determined by turning the equipment off and on, the user is encouraged to try to correct the interference by one or more of the following measures:

- Reorient or relocate the receiving antenna.
- Increase the separation between the equipment and receiver.
- Connect the equipment into an outlet on a circuit different from that to which the receiver is connected.
- Consult the dealer or an experienced radio/TV technician for help.

WARNING: Changes or modifications not expressly approved by the party responsible for compliance could void the user's authority to operate the equipment. This equipment complied with FCC radiation exposure limits set forth for an uncontrolled environment. This equipment should be installed and operated with minimum distance 20cm between the radiator & your body.

NOTE: The manufacturer is not responsible for any radio or TV interference caused by unauthorized modifications to this equipment. Such modifications could void the user's authority to operate the equipment.



2602 Marina Drive • Elkhart, IN 46514
www.asaelectronics.com



ENGLISH

Easy Setup Guide

Please read this manual carefully before operating your set and retain it for future reference.

FRANÇAIS

Guide de configuration rapide

Avant d'utiliser l'appareil, veuillez lire attentivement ce manuel et le conserver pour pouvoir vous y reporter ultérieurement.

ESPAÑOL

Guía Rápida de Configuración

Lea atentamente este manual antes de poner en marcha el equipo y consérvelo para futuras consultas.

**LED TV
TÉLÉVISEUR DEL
TV MONITOR LED
24LH4830**

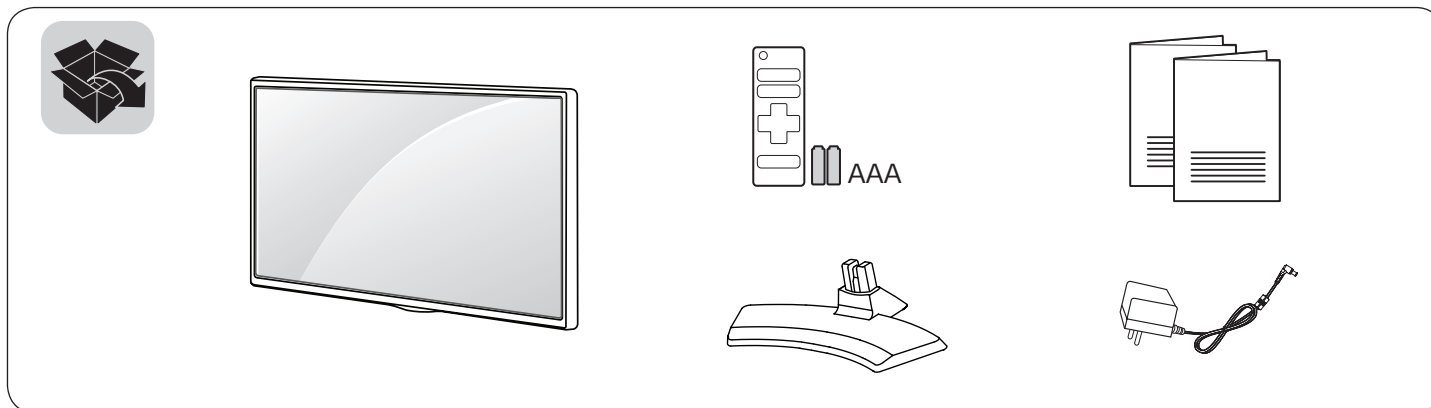

www.lg.com



ENGLISH

Read Safety and Reference.

FRANÇAIS

Lire le document Sécurité et références.

ESPAÑOL

Leer Seguridad y Consultas.



P/No: MBM65369302 (1607-REV00)

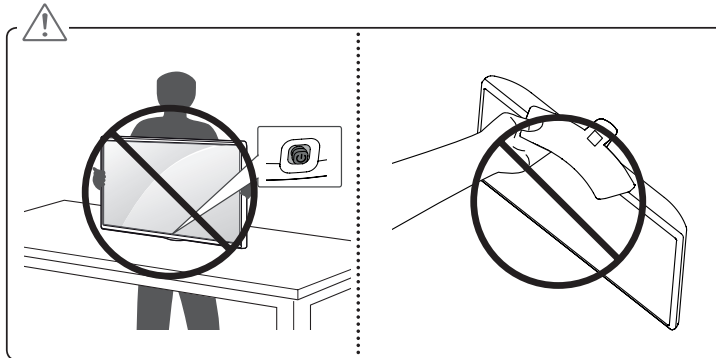
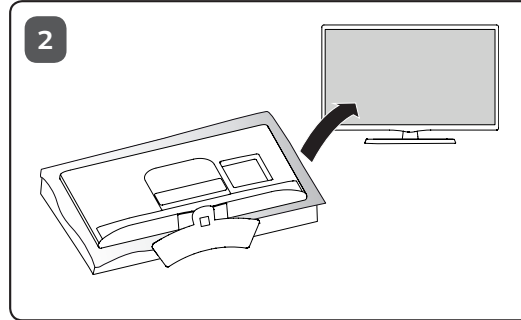
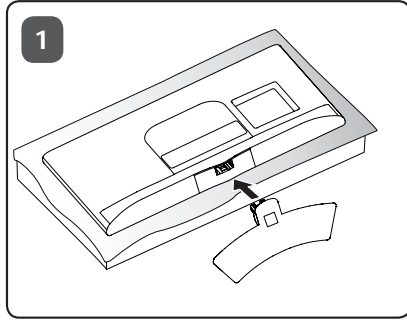

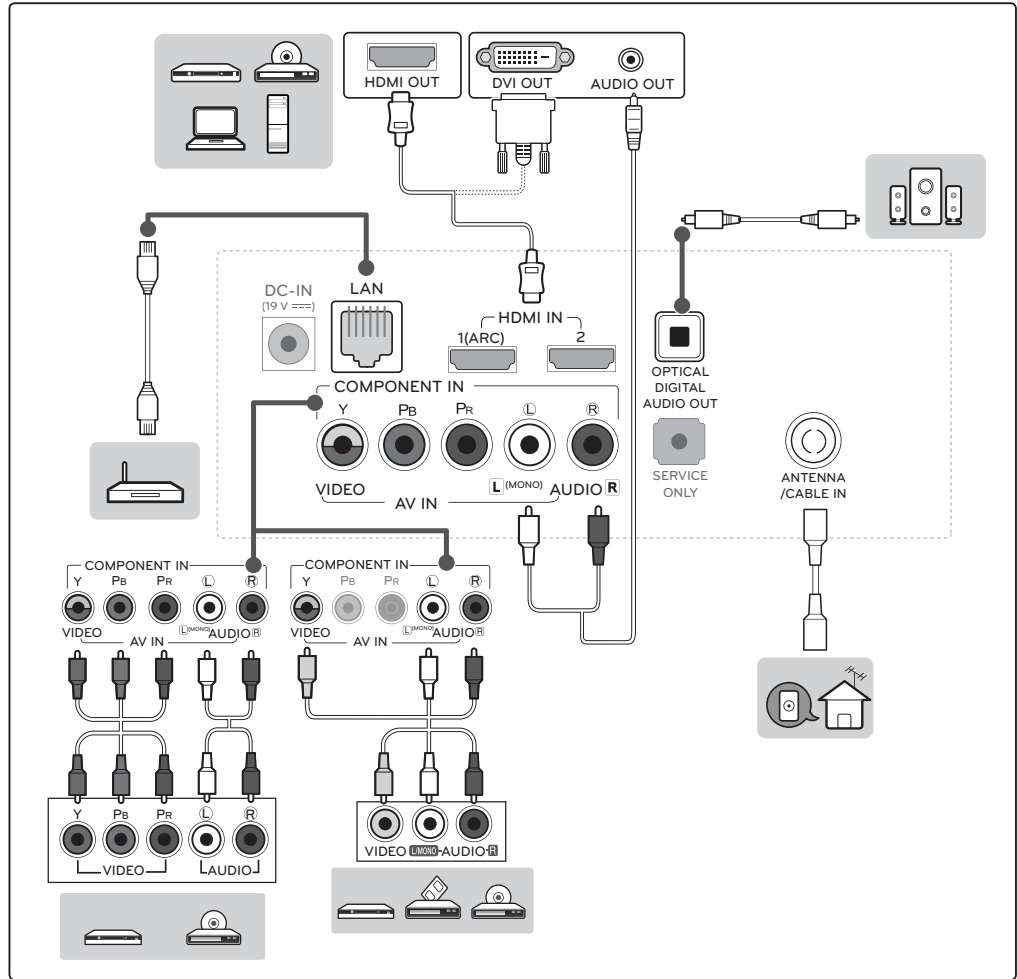
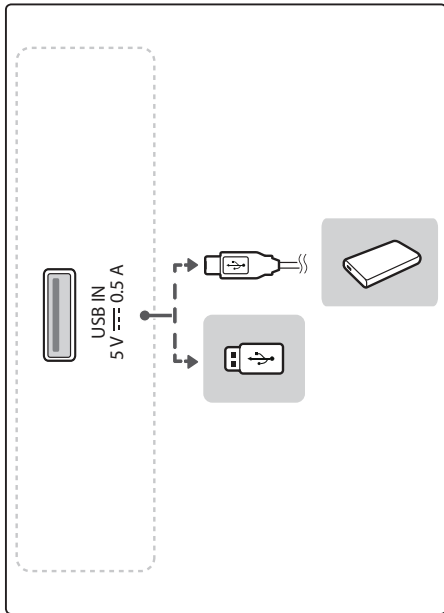
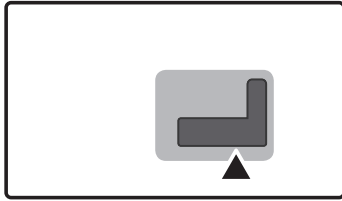



DC-IN
(19V \Rightarrow)

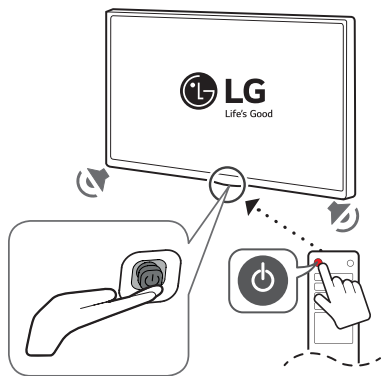
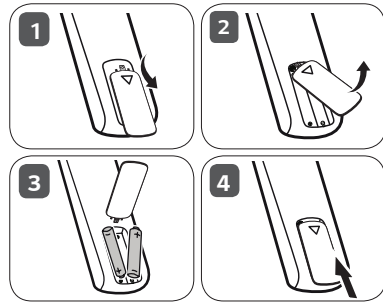
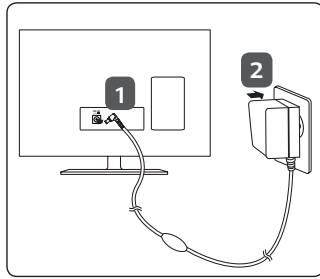

ENGLISH

MODELS		24LH4830
Dimensions (W x H x D)	With stand	556 x 387.3 x 146.3 (mm) 21.8 x 15.2 x 5.7 (inches)
	Without stand	556 x 345.2 x 53.1 (mm) 21.8 x 13.5 x 2.0 (inches)
Weight	With stand	3.4 kg (7.4 lbs)
	Without stand	3.2 kg (7.0 lbs)

FRANÇAIS

MODÈLES		24LH4830
Dimensions (L x H x P)	Avec support	556 x 387,3 x 146,3 (mm) 21,8 x 15,2 x 5,7 (po)
	Sans support	556 x 345,2 x 53,1 (mm) 21,8 x 13,5 x 2,0 (po)
Poids	Avec support	3,4 kg (7,4 lb)
	Sans support	3,2 kg (7,0 lb)

ESPAÑOL

MODELOS		24LH4830
Dimensiones (Ancho x Altura x Profundidad)	Con base	556 x 387,3 x 146,3 (mm)
	Sin base	556 x 345,2 x 53,1 (mm)
Peso	Con base	3,4 (kg)
	Sin base	3,2 (kg)
Consumo de energía (Condición predeterminada)		24 W
Consumo de energía		19 V \Rightarrow 2,0 A
Adaptador de CA-CC	Entrada	AC 100-240 V - 50/60 Hz
	Salida	19 V \Rightarrow 2,1 A



OWNER'S MANUAL

Safety and Reference

LED TV*

* LG LED TVs are LCD TVs with LED backlighting.

Please read this manual carefully before operating your TV and retain it for future reference.

24LH4830



www.lg.com

P/No : MFL69376202 (1607-REV00)

Table of contents

3 Important safety instructions

7 Licenses

7 Open source software notice information

7 Preparing

8 Lifting and moving the TV

8 Setting up the TV

8 Using the joystick button

- 8 Basic functions
- 9 Adjusting the menu

9 Mounting on a table

9 Using the kensington security system (optional)

10 Mounting on a wall

11 Connections (Notifications)

- 11 Connecting to an antenna or cable
- 11 Other Connections

12 Remote control

13 Troubleshooting

14 Specifications

15 Regulatory

 **WARNING** : This product contains chemicals known to the State of California to cause cancer and birth defects or other reproductive harm. ***Wash hands after handling.***

Important safety instructions

Always comply with the following precautions to avoid dangerous situations and ensure peak performance of your product.





WARNING/CAUTION

RISK OF ELECTRIC SHOCK
DO NOT OPEN



TO REDUCE THE RISK OF ELECTRIC SHOCK DO NOT REMOVE COVER (OR BACK). NO USER SERVICEABLE PARTS INSIDE. REFER TO QUALIFIED SERVICE PERSONNEL.

 The lightning flash with arrowhead symbol, within an equilateral triangle, is intended to alert the user to the presence of uninsulated dangerous voltage within the product's enclosure that may be of sufficient magnitude to constitute a risk of electric shock to persons.

 The exclamation point within an equilateral triangle is intended to alert the user to the presence of important operating and maintenance (servicing) instructions in the literature accompanying the device.

WARNING/CAUTION

- TO REDUCE THE RISK OF FIRE AND ELECTRIC SHOCK, DO NOT EXPOSE THIS PRODUCT TO RAIN OR MOISTURE.

 **WARNING**

If you ignore the warning message, you may be seriously injured or there is a possibility of accident or death.

 **CAUTION**

If you ignore the caution message, you may be slightly injured or the product may be damaged.

 **NOTE**

The note helps you understand and use the product safely. Please read the note carefully before using the product.

Read these instructions.
Keep these instructions.
Heed all warnings.
Follow all instructions.



- Do not use this apparatus near water.



- Clean only with dry cloth.



- Do not block any ventilation openings. Install in accordance with the manufacturer's instructions.



- Do not install near any heat sources such as radiators, heat registers, stoves, or other apparatus (including amplifiers) that produce heat.



- Do not defeat the safety purpose of the polarized or grounding-type plug. A polarized plug has two blades with one wider than the other. A grounding type plug has two blades and a third grounding prong. The wide blade or the third prong are provided for your safety. If the provided plug does not fit into your outlet, consult an electrician for replacement of the obsolete outlet.



- Protect the power cord from being walked on or pinched particularly at plugs, convenience receptacles, and the point where they exit from the apparatus.



- Only use attachments/accessories specified by the manufacturer.



- Use only with the cart, stand, tripod, bracket, or table specified by the manufacturer, or sold with the apparatus. When a cart is used, use caution when moving the cart/apparatus combination to avoid injury from tip-over.



- Unplug this apparatus during lightning storms or when unused for long periods of time.



- Refer all servicing to qualified service personnel. Servicing is required when the apparatus has been damaged in any way, such as power-supply cord or plug is damaged, liquid has been spilled or objects have fallen into the apparatus, the apparatus has been exposed to rain or moisture, does not operate normally, or has been dropped.



- Do not press strongly upon the panel with a hand or a sharp object such as a nail, pencil, or pen, or make a scratch on it.



- Do not stick metal objects or any other conductive material into the power cord. Do not touch the end of the power cord while it is plugged in.
- Keep the packing anti-moisture material or vinyl packing out of the reach of children. Anti-moisture material is harmful if swallowed. If swallowed, induce vomiting and go to the nearest hospital. Additionally, vinyl packing can cause suffocation. Keep it out of the reach of children.

- CAUTION concerning the Power Cord (Can differ by country):
Check the specification page of this owner's manual to be certain concerning current requirements. Do not connect too many devices to the same AC power outlet as this could result in fire or electric shock. Do not overload wall outlets. Overloaded wall outlets, loose or damaged wall outlets, extension cords, frayed power cords, or damaged or cracked wire insulation are dangerous. Any of these conditions could result in electric shock or fire. Periodically examine the cord of your device, and if its appearance indicates damage or deterioration, unplug it, discontinue use of the device, and have the cord replaced with an exact replacement part by an authorized servicer. Protect the power cord from physical or mechanical abuse, such as being twisted, kinked, pinched, closed in a door, or walked upon. Pay particular attention to plugs, wall outlets, and the point where the cord exits the device. Do not move the TV with the power cord plugged in. Do not use a damaged or loose power cord. Be sure do grasp the plug when unplugging the power cord. Do not pull on the power cord to unplug the TV.



- **Warning** - To reduce the risk of fire or electrical shock, do not expose this product to rain, moisture or other liquids. Do not touch the TV with wet hands. Do not install this product near flammable objects such as gasoline or candles, or expose the TV to direct air conditioning.



- Do not expose to dripping or splashing and do not place objects filled with liquids, such as vases, cups, etc. on or over the apparatus (e.g., on shelves above the unit).



• **Grounding**

- (Except for devices which are not grounded)
Ensure that you connect the earth ground wire to prevent possible electric shock (i.e., a TV with a three-prong grounded AC plug must be connected to a three-prong grounded AC outlet).

If grounding methods are not possible, have a qualified electrician install a separate circuit breaker. Do not try to ground the unit by connecting it to telephone wires, lightning rods, or gas pipes.

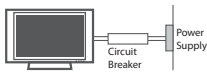

- As long as this unit is connected to the AC wall outlet, it is not disconnected from the AC power source even if the unit is turned off.
- Do not attempt to modify this product in any way without written authorization from LG Electronics. Unauthorized modification could void the user's authority to operate this product.

• **Outdoor Antenna Grounding**

- (Can differ by country):
If an outdoor antenna is installed, follow the precautions below. An outdoor antenna system should not be located in the vicinity of overhead power lines or other electric light or power circuits, or where it can come in contact with such power lines or circuits as death or serious injury can occur. Be sure the antenna system is grounded to provide some protection against voltage surges and built-up static charges. Section 810 of the National Electrical Code (NEC) in the U.S.A. provides information with respect to proper grounding of the mast and supporting structure, grounding of the lead-in wire to an antenna discharge unit, size of grounding conductors, location of antenna discharge unit, connection to grounding electrodes, and requirements for the grounding electrode.

• **Antenna grounding according to the National Electrical Code, ANSI/NFPA 70**

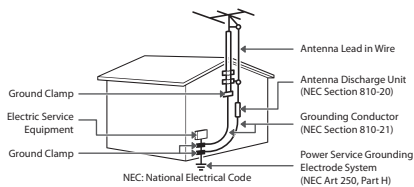

• **Cleaning**

- When cleaning, unplug the power cord and wipe gently with a soft cloth to prevent scratching. Do not spray water or other liquids directly on the TV as electric shock may occur. Do not clean with chemicals such as alcohol, thinners, or benzene.

• **Moving**

- Make sure the product is turned off, unplugged, and all cables have been removed. It may take 2 or more people to carry larger TVs. Do not press or put stress on the front panel of the TV.

• **Ventilation**

- Install your TV where there is proper ventilation. Do not install in a confined space such as a bookcase. Do not cover the product with cloth or other materials while plugged in. Do not install in excessively dusty places.
- If you smell smoke or other odors coming from the TV, unplug the power cord and contact an authorized service center.
- If water or another substance enters the product (like an AC adapter, power cord, or TV), disconnect the power cord and contact the service center immediately. Otherwise, this may result in fire or electric shock.



- Use only an authorized AC adapter and power cord approved by LG Electronics. Otherwise, this may result in fire, electric shock, malfunction, or product deformation.

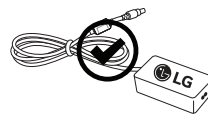

- Never disassemble the AC adapter or power cord. This may result in fire or electric shock.



- Handle the adapter carefully to avoid dropping or striking it. An impact could damage the adapter.



- Keep the product away from direct sunlight.
- Never touch this apparatus or antenna during a lightning storm.
- When mounting a TV on the wall, make sure not to install the TV by hanging the power and signal cables on the back of the TV.
- Do not allow an impact shock or any objects to fall into the product, and do not drop anything onto the screen.
- **DISCONNECTING THE DEVICE FROM THE MAIN POWER**
The power plug is the disconnecting device. In case of an emergency, the power plug must remain readily accessible.
- Make sure the power cord is connected securely to the power plug on the TV.

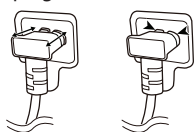

• Batteries

- Store the accessories (battery, etc.) in a safe location out of the reach of children.
- This apparatus uses batteries. In your community there might be regulations that require you to dispose of these batteries properly due to environmental considerations. Please contact your local authorities for disposal or recycling information.
- Do not dispose of batteries in a fire.
- Do not short circuit, disassemble, or allow the batteries to overheat.
- Do not use high voltage electrical equipment near the TV, (e.g., a bug zapper). This may result in product malfunction.

• Dot Defect

- The panel is a high technology product with resolution of two million to six million pixels. In a very few cases, you could see fine dots on the screen while you're viewing the TV. Those dots are deactivated pixels and do not affect the performance and reliability of the TV.

• Generated Sound

- **Cracking noise** A cracking noise that occurs when watching or turning off the TV is generated by plastic thermal contraction due to temperature and humidity. This noise is common for products where thermal deformation is required.
- **Electrical circuit humming/panel buzzing** A low level noise is generated from a high-speed switching circuit, which supplies a large amount of current to operate a product. It varies depending upon the product. This generated sound does not affect the performance and reliability of the product.
- Take care not to touch the ventilation openings. When watching the TV for a long period, the ventilation openings may become hot. This does not affect the performance of the product or cause defects in the product.
- Do not install this product on a wall if it could be exposed to oil or oil mist. This may damage the product and cause it to fall.
- If the TV feels cold to the touch, there may be a small flicker when it is turned on. This is normal; there is nothing wrong with TV. Some minute dot defects may be visible on the screen, appearing as tiny red, green, or blue spots. However, they have no adverse effect on the TV's performance. Avoid touching the LCD screen or holding your finger(s) against it for long periods of time. Doing so may produce some temporary distortion effects on the screen.
- Displaying a still image for a prolonged period of time may cause an image sticking. Avoid displaying a fixed image on the TV screen for a extended length of time.

Licenses

Supported licenses may differ by model.
For more information about licenses,
visit www.lg.com.



Open source software notice information

To obtain the source code under GPL, LGPL, MPL, and other open source licenses, that is contained in this product, please visit <http://opensource.lge.com>.

In addition to the source code, all referred license terms, warranty disclaimers and copyright notices are available for download.

LG Electronics will also provide open source code to you on CD-ROM for a charge covering the cost of performing such distribution (such as the cost of media, shipping, and handling) upon email request to opensource@lge.com. This offer is valid for three (3) years from the date on which you purchased the product.

Preparing

NOTE

- If the TV is turned on for the first time after it was shipped from the factory, initialization of the TV may take a few minutes.
- Image shown may differ from your TV.
- Your TV's OSD (On Screen Display) may differ slightly from that shown in this manual.
- The available menus and options may differ from the input source or product model that you are using.
- New features may be added to this TV in the future.
- The items supplied with your product may vary depending upon the model.
- Product specifications or contents of this manual may be changed without prior notice due to upgrade of product functions.
- For an optimal connection, HDMI cables and USB devices should have bezels less than 10 mm (0.39 inches) thick and 18 mm (0.7 inches) width.
- Use an extension cable that supports USB 2.0 if the USB cable or USB flash drive does not fit into your TV's USB port.
- Use a certified cable with the HDMI logo attached. If you do not use a certified HDMI cable, the screen may not display or a connection error may occur.
- Recommended HDMI cable types
 - High-Speed HDMI[®]/™ cable
 - High-Speed HDMI[®]/™ cable with Ethernet

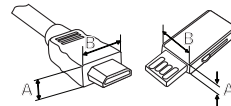

*A ≤ 10 mm (0.39 inches)

*B ≤ 18 mm (0.7 inches)

- This Smart TV is for VOD (Video On Demand) service, some smart functions may not be supported including web browser.

CAUTION

- Do not use any unapproved items to ensure the safety and product's lifespan.
- Any damages or injuries by using unapproved items are not covered by the warranty.
- Some models appear to have a thin film on the screen. It is actually part of the screen; do not remove it.
- When attaching the stand to the TV set, place the screen facing down on a cushioned table or flat surface to protect the screen from scratches.

Lifting and moving the TV

When moving or lifting the TV, read the following to prevent the TV from being scratched or damaged and for safe transportation regardless of its type and size.

- It is recommended to move the TV in the box or packing material that the TV originally came in.
- Before moving or lifting the TV, disconnect the power cord and all cables.
- When holding the TV, the screen should face away from you to avoid damage.
- Hold the top and bottom of the TV frame firmly. Make sure not to hold the transparent part, speaker, or speaker grille area.

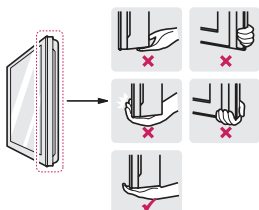

- When transporting the TV, do not expose the TV to jolts or excessive vibration.
- When transporting the TV, keep the TV upright; never turn the TV on its side or tilt towards the left or right.
- When handling the TV, be careful not to damage the protruding buttons.

⚠ CAUTION

- Avoid touching the screen at all times, as this may result in damage to the screen.
- Do not place the product on the floor with its front facing down without padding. Failure to do so may result in damage to the screen.

Setting up the TV

⚠ CAUTION

- Do not carry the TV upside-down as this may cause it to fall off its stand, resulting in damage or injury.
- When attaching the stand to the TV set, place the screen facing down on a cushioned table or flat surface to protect the screen from scratches.

! NOTE

- Lift up the latch at the bottom of the stand base and detach the stand base from the TV.

Using the joystick button

(Image shown may differ from your TV.)

You can operate the TV by pressing the button or moving the joystick left, right, up, or down.

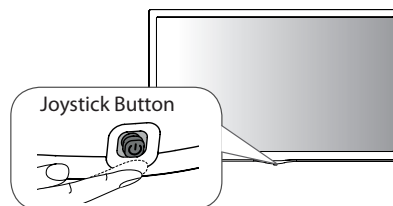





Basic functions

	Power On (Press) Power Off (Press and Hold) ¹
	Volume Control
	Channels Control

- ¹ If the menu button is on the screen, pressing and holding the joystick button will let you exit the menu.

Adjusting the menu

When the TV is turned on, press the joystick button one time. You can adjust the menu items moving the joystick button up, down, left, or right.

	Turns the power off.
	Accesses the main menu.
	Clears on-screen displays and returns to TV viewing.
	Changes the input source.

NOTE

- If you press the joystick button first, you can not adjust the volume level and saved channels.

CAUTION

- When your finger over the joystick button and push it to the up, down, left or right, be careful not to press the joystick button.

Mounting on a table

- 1 Lift and tilt the TV into its upright position on a table.
 - Leave a 100 mm (3.9 inches) (minimum) space from the wall for proper ventilation.

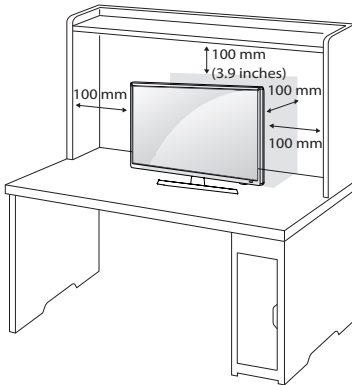

- 2 Connect the power cord to a wall outlet.

CAUTION

- Do not place the TV near or on sources of heat, as this may result in fire or other damage.

Using the kensington security system (optional)

(Depending upon model)

The Kensington security system connector is located at the rear of the TV. For more information of installation and using, refer to the manual provided with the Kensington security system or visit <http://www.kensington.com>. Connect the Kensington security system cable between the TV and a table.

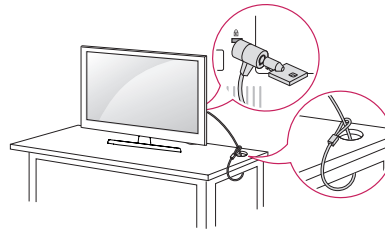

NOTE

- The Kensington security system is optional. You can obtain additional accessories from your local dealer.

Mounting on a wall

An optional wall mount can be used with your LG Television. Consult with your local dealer for a wall mount that supports the VESA standard used by your TV model. Carefully attach the wall mount bracket at the rear of the TV. Install the wall mount bracket on a solid wall perpendicular to the floor. If you are attaching the TV to other building materials, please contact qualified personnel to install the wall mount. Detailed instructions will be included with the wall mount. We recommend that you use an LG brand wall mount. The LG wall mount is easy to adjust or to connect the cables. When you do not use LG's wall mount bracket, use a wall mount bracket where the device is adequately secured to the wall with enough space to allow connectivity to external devices. If you are using a non-adjustable mount, attach the mount to the wall. Attach the cables to the TV first, then attach the TV to the mount.

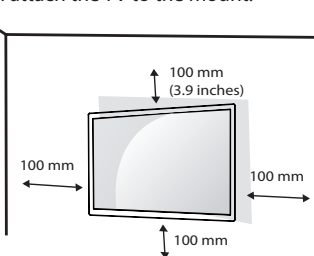

Make sure to use screws and wall mounts that meet the VESA standard. Standard dimensions for the wall mount kits are described in the following table.

Model	24LH4830
VESA (A x B)	75 x 75
Standard screw	M4
Number of screws	4
Wall mount bracket (optional)	RW120

⚠ CAUTION

- Disconnect the power before moving or installing the TV. Otherwise electric shock may occur.
- Remove the stand before installing the TV on a wall mount by performing the stand attachment in reverse.
- If you install the TV on a ceiling or slanted wall, it may fall and result in severe injury. Use an authorized LG wall mount and contact the local dealer or qualified personnel. When using a third-party wall mount, it is not covered by the warranty.
- Do not overtighten the screws as this may cause damage to the TV and void your warranty.
- Use the screws and wall mounts that meet the VESA standard. Any damages or injuries by misuse or using an improper accessory are not covered by the warranty.
- Screw length from outer surface of back cover should be under 8 mm (0.3 inches).

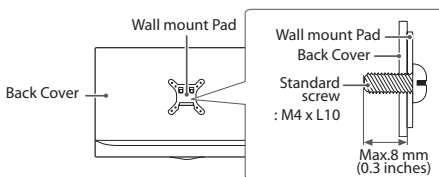

! NOTE

- Use the screws that are listed on the VESA standard screw specifications.
- The wall mount kit includes an installation manual and necessary parts.
- The wall mount bracket is optional. You can obtain additional accessories from your local dealer.
- The length of screws may differ depending upon the wall mount. Make sure to use the proper length.
- For more information, refer to the manual supplied with the wall mount.

Connections (Notifications)

You can connect various external devices to the TV. Supported external devices are: HD receivers, DVD players, VCRs, audio systems, USB storage devices, PC, gaming devices, and other external devices. For more information on an external device's connection, refer to the manual provided with each device.

NOTE

- If you record a TV program on a DVD recorder or VCR, make sure to connect the TV signal input cable to the TV through a DVD recorder or VCR. For more information about recording, refer to the manual provided with the connected device.
- The external device connections shown may differ slightly from illustrations in a manual.
- Connect external devices to the TV regardless about the order of the TV port.
- If you connect a gaming device to the TV, use the cable supplied with the gaming device.
- Refer to the external equipment's manual for operating instructions.
- In PC mode, there may be noise associated with the resolution, vertical pattern, contrast, or brightness. If noise is present, change the PC output to another resolution, change the refresh rate to another rate, or adjust the brightness and contrast on the **PICTURE** menu until the picture is clear.
- Depending upon the graphics card, some resolution settings may not allow the image to be positioned on the screen properly.

Connecting to an antenna or cable

Connect an antenna, cable, or cable box to watch TV. The illustrations may differ from the actual items and an RF cable is optional.

CAUTION

- Make sure not to bend the copper wire of the RF cable.



- Complete all connections between devices, and then connect the power cord to the power outlet to prevent damage to your TV.

NOTE

- Use a signal splitter to use 2 TVs or more.
- DTV Audio Supported Codec: MPEG, Dolby Digital.

Other Connections

Connect your TV to external devices. For the best picture and audio quality, connect the external device and the TV with the HDMI cable. Depending upon the model, a cable may not be provided.

Remote control

The descriptions in this manual are based on the buttons on the remote control. Please read this manual carefully and use the TV correctly. To install batteries, open the battery cover, replace batteries (1.5 V AAA) matching the ⊕ and ⊖ ends to the label inside the compartment, and close the battery cover. Failure to match the correct polarities of the battery may cause the battery to burst or leak, resulting in fire, personal injury, or ambient pollution. To remove the batteries, perform the installation actions in reverse. This remote uses infrared light. When in use, it should be pointed in the direction of the TV's remote sensor.

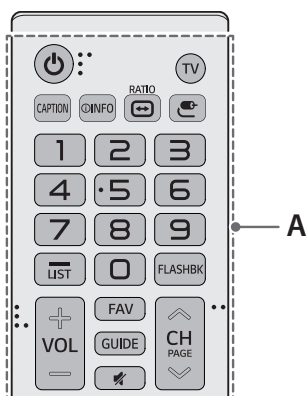

A

- ⏻ (Power)** Turns the TV on or off.
- TV** Returns to the last TV channel.
- CAPTION** Activates or deactivates the subtitles.
- ⓘ INFO** Shows information on the current program.
- ⏏ RATIO** Resizes an image.
- 📺 (Input)** Changes the input source.
- Number buttons** Enters numbers.
- (Dash)** Inserts a dash between numbers such as 2-1 and 2-2.
- LIST** Accesses the saved channel list.
- FLASHBK** Alternates between the two last channels selected (pressing repeatedly).
- + VOL —** Adjusts the volume level.
- FAV** Accesses your favorite channel list.

GUIDE Displays the program event according to time scheduler.

- 🔇 (Mute)** Mutes all sounds.
- ^ CH v** Scrolls through the saved channels.
- ^ PAGE v** Moves to the previous or next screen.

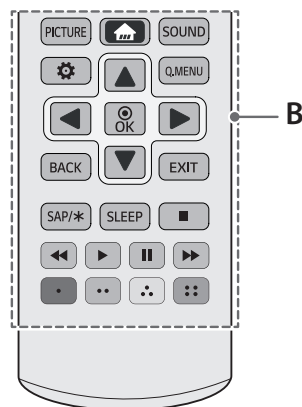

B

- PICTURE** Changes the picture mode.
- 🏠 (Home)** Accesses the Home menu.
- SOUND** Changes the sound mode.
- ⚙️ (Settings)** Accesses the settings.
- Q.MENU** Accesses the quick menu.
- Navigation buttons** (up, down, left, right) Scrolls through menus or options.
- ⊙ OK** Selects menus or options and confirms your input.
- BACK** Returns to the previous screen.
- EXIT** Clears all on-screen displays and returns to TV viewing.
- SAP/*** Enables SAP (Secondary Audio Program) feature. (Depending upon model)
- SLEEP** Sets the length of time until the TV to turns off.
- , ⏪, ▶, ⏸, ⏩** Control buttons for media contents
- Color buttons** (🔴 Red, 🟢 Green, 🟡 Yellow, 🔵 Blue) These access special functions in some menus.

Troubleshooting

- Cannot control the TV with the remote control.
 - Check if anything such as tape has been placed over the receiver.
 - Check if there is any obstacle between the product and the remote control.
 - Replace the batteries with new ones.
- No image display and no sound is produced.
 - Check if the product is turned on.
 - Check if the power cord is connected to a wall outlet.
 - Check if there is a problem in the wall outlet by connecting other products.
- The TV turns off suddenly.
 - Check the power control settings. The power supply may be interrupted.
 - Check if the **Sleep Timer/Timer Power Off** feature is activated in the **Timers** settings.
 - If there is no signal while the TV is on, the TV will turn off automatically after 15 minutes of inactivity.

Specifications

Product specifications may be changed without prior notice due to upgrade of product functions. Estimated yearly energy consumption indicated on the FTC label is measured in accordance with the Test Procedures for Television Sets (USA only). The actual energy consumption depends on the usage environment (The content watched, TV settings, etc.).

ENGLISH

Models	Dimensions (W x H x D)		Weight		Power consumption (Outgoing condition)	Power requirement
	With stand	Without stand	With stand	Without stand		
24LH4830	556 x 387.3 x 146.3 (mm)	556 x 345.2 x 53.1 (mm)	3.4 (kg)	3.2 (kg)	24 W	19 V --- 2.0 A
	21.8 x 15.2 x 5.7 (inches)	21.8 x 13.5 x 2.0 (inches)	7.4 (lbs)	7.0 (lbs)		

AC/DC Adapter	Manufacturer : Lien Chang Model : LCAP16B-A Manufacturer : Honor Model : ADS-45FSN-19 19040GPCU
	In : AC 100 – 240 V ~ 50/60 Hz Out : DC 19 V --- 2.1 A

Environment condition	Operating Temperature	0 °C to 40 °C (32 °F to 104 °F)
	Operating Humidity	Less than 80 %
	Storage Temperature	-20 °C to 60 °C (-4 °F to 140 °F)
	Storage Humidity	Less than 85 %

Television System	ATSC, NTSC-M, 64 & 256 QAM
Program Coverage	VHF 2-13, UHF 14-69, CATV 1-135, DTV 2-69, CADTV 1-135
External Antenna Impedance	75 Ω

Wireless LAN module (WN8122E1) Specifications	
Standard	IEEE 802.11a/b/g/n
Frequency Range	2400 to 2483.5 MHz 5150 to 5250 MHz 5725 to 5850 MHz
Output Power (Max.)	802.11a: 16.5 dBm 802.11b: 16 dBm 802.11g: 15.5 dBm 802.11n - 2.4 GHz: 15.5 dBm 802.11n - 5 GHz: 16.5 dBm
<ul style="list-style-type: none"> As band channels can vary per country, the user cannot change or adjust the operating frequency. This product is configured for the regional frequency table. For consideration of the user, this device should be installed and operated with a minimum distance of 20 cm (7.8 inches) between the device and the body. Contains FCC ID: BEJWN8122E1/Contains IC: 2703H-WN8122E1 	

Regulatory

FCC Notice

(For USA)

This equipment has been tested and found to comply with the limits for a Class B digital device, pursuant to Part 15 of the FCC Rules. These limits are designed to provide reasonable protection against harmful interference in a residential installation. This equipment generates, uses and can radiate radio frequency energy and, if not installed and used in accordance with the instructions, may cause harmful interference to radio communications. However, there is no guarantee that interference will not occur in a particular installation. If this equipment does cause harmful interference to radio or television reception, which can be determined by turning the equipment off and on, the user is encouraged to try to correct the interference by one or more of the following measures:

- Reorient or relocate the receiving antenna.
- Increase the separation between the equipment and the receiver.
- Connect the equipment to an outlet on a circuit different from that to which the receiver is connected.
- Consult the dealer or an experienced radio/TV technician for help.

This device complies with part 15 of the FCC Rules. Operation is subject to the following two conditions: (1) this device may not cause harmful interference and (2) this device must accept any interference received, including interference that may cause undesired operation of the device. Any changes or modifications in construction of this device which are not expressly approved by the party responsible for compliance could void the user's authority to operate the equipment.

FCC Radio Frequency Interference Requirements (for UNII devices)

High power radars are allocated as primary users of the 5.25 to 5.35 GHz and 5.65 to 5.85 GHz bands. These radar stations can cause interference with and/or damage this device. This device cannot be co-located with any other transmitter.

FCC RF Radiation Exposure Statement

[For having wireless function (WLAN, Bluetooth,...)]

This equipment complies with FCC radiation exposure limits set forth for an uncontrolled environment. This transmitter must not be colocated or operating in conjunction with any other antenna or transmitter. This equipment should be installed and operated with minimum distance 20 cm (7.8 inches) between the radiator and your body. Users must follow the specific operating instructions for satisfying RF exposure compliance.

Industry Canada Statement

(For Canada)

[For having wireless function (WLAN, Bluetooth,...)]

This device complies with Industry Canada's licence-exempt RSSs. Operation is subject to the following two conditions:

1. This device may not cause interference; and
2. This device must accept any interference, including interference that may cause undesired operation of the device.

IC Radiation Exposure Statement

(For Canada)

[For having wireless function (WLAN, Bluetooth,...)]

This equipment complies with IC radiation exposure limits set forth for an uncontrolled environment. This equipment should be installed and operated with minimum distance 20 cm (7.8 inches) between the antenna & your body.

NOTE : THE MANUFACTURER IS NOT RESPONSIBLE FOR ANY RADIO OR TV INTERFERENCE CAUSED BY UNAUTHORIZED MODIFICATIONS TO THIS EQUIPMENT. SUCH MODIFICATIONS COULD VOID THE USER'S AUTHORITY TO OPERATE THE EQUIPMENT.

⚠ WARNING

(For Canada)

[For product having the wireless function using 5 GHz frequency bands]

- The device for operation in the band 5150–5250 MHz is only for indoor use to reduce the potential for harmful interference to co-channel mobile satellite systems;
- For devices with detachable antenna(s), the maximum antenna gain permitted for devices in the bands 5250-5350 MHz and 5470-5725 MHz shall be such that the equipment still complies with the e.i.r.p. limit;
- For devices with detachable antenna(s), the maximum antenna gain permitted for devices in the band 5725-5850 MHz shall be such that the equipment still complies with the e.i.r.p. limits specified for point-to-point and non-point-to-point operation as appropriate; and
- The worst-case tilt angle(s) necessary to remain compliant with the e.i.r.p. elevation mask requirement set forth in Section 6.2.2(3) shall be clearly indicated.(devices operating in the band 5250-5350 MHz with a maximum e.i.r.p. greater than 200 mW)
- High-power radars are allocated as primary users (i.e. priority users) of the bands 5250–5350 MHz and 5650–5850 MHz and that these radars could cause interference and/or damage to LE-LAN devices.

Note to cable/TV installer

(For USA and Canada)

This reminder is provided to call the CATV system installer's attention to Article 820-40 of the National Electric Code (U.S.A.). The code provides guidelines for proper grounding and, in particular, specifies that the cable ground shall be connected to the grounding system of the building, as close to the point of the cable entry as practical.







WARNING!

Never place a television set in an unstable location. A television set may fall, causing serious personal injury or death. Many injuries, particularly to children, can be avoided by taking simple precautions such as:

- Using cabinets or stands recommended by the manufacturer of the television set.
- Only using furniture that can safely support the television set.
- Ensuring the television set is not overhanging the edge of the supporting furniture.
- Not placing the television set on tall furniture (for example, cupboards or bookcases) without anchoring both the furniture and the television set to a suitable support.
- Not placing the television set on cloth or other materials that may be located between the television set and supporting furniture.
- Educating children about the dangers of climbing on furniture to reach the television set or its controls.

If your existing television set is being retained and relocated, the same considerations as above should be applied.

Symbols

	Refers to alternating current(AC).
	Refers to direct current(DC).
	Refers to class II equipment.
	Refers to stand-by.
	Refers to "ON" (power).
	Refers to dangerous voltage.

LG Recycling Policy

(For USA)

LG Electronics offers a customized e-waste takeback and recycling service that meets local needs and requirements in the countries where e-waste regulations are in place, and also provides product and packaging take-back and recycling service voluntarily in some countries. LG Electronics evaluates products' recyclability at the design step using LG's recyclability evaluation tool, with the goal of improving recyclability where practicable. Through these activities, LG seeks to contribute to conserving natural resources and protecting the environment. For more information about the LG Recycling Policy, please visit our global site at <http://www.lg.com/global/sustainability/environment/take-back-recycling>

CHILD SAFETY:

PROPER TELEVISION PLACEMENT MATTERS



THE CONSUMER ELECTRONICS INDUSTRY CARES

- Manufacturers, retailers and the rest of the consumer electronics industry are committed to making home entertainment safe and enjoyable.
- As you enjoy your television, please note that all televisions – new and old- must be supported on proper stands or installed according to the manufacturer's recommendations. Televisions that are inappropriately situated on dressers, bookcases, shelves, desks, speakers, chests, carts, etc., may fall over, resulting in injury.



TUNE IN TO SAFETY

- **ALWAYS** follow the manufacturer's recommendations for the safe installation of your television.
- **ALWAYS** read and follow all instructions for proper use of your television.
- **NEVER** allow children to climb on or play on the television or the furniture on which the television is placed.
- **NEVER** place the television on furniture that can easily be used as steps, such as a chest of drawers.
- **ALWAYS** install the television where it cannot be pushed, pulled over or knocked down.
- **ALWAYS** route cords and cables connected to the television so that they cannot be tripped over, pulled or grabbed.



WALL OR CEILING MOUNT YOUR TELEVISION

- **ALWAYS** contact your retailer about professional installation if you have any doubts about your ability to safely mount your television.
- **ALWAYS** use a mount that has been recommended by the television manufacturer and has a safety certification by an independent laboratory (such as UL, CSA, ETL).
- **ALWAYS** follow all instructions supplied by the television and mount manufacturers.
- **ALWAYS** make sure that the wall or ceiling where you are mounting the television is appropriate. Some mounts are not designed to be mounted to walls and ceilings with steel studs or cinder block construction. If you are unsure, contact a professional installer.
- Televisions can be heavy. A minimum of two people is required for a wall or ceiling mount installation.



MOVING AN OLDER TELEVISION TO A NEW PLACE IN YOUR HOME

- Many new television buyers move their older CRT televisions into a secondary room after the purchase of a flat-panel television. Special care should be made in the placement of older CRT televisions.
- **ALWAYS** place your older CRT television on furniture that is sturdy and appropriate for its size and weight.
- **NEVER** place your older CRT television on a dresser where children may be tempted to use the drawers to climb.
- **ALWAYS** make sure your older CRT television does not hang over the edge of your furniture.



LG Customer Information Center
For inquires or comments, visit www.lg.com or call;

1-888-542-2623	CANADA
1-800-243-0000	USA, Consumer User
1-888-865-3026	USA, Commercial User

Register your product Online!
www.lg.com

Declaration of Conformity
Trade Name: LG
Model: 24LH4830
Responsible Party: LG Electronics Inc.
Address: 1000 Sylvan Ave. Englewood Cliffs NJ 07632 U.S.A
TEL: 201-266-2534

Please note that the label attached to the product provides information for technical support. Record them below should you ever need service.

MODEL _____
SERIAL _____



This product qualifies for ENERGY STAR® in the factory default (Home configuration) setting. Changing the factory default settings or enabling other features may increase power consumption that could exceed the limits necessary to qualify for ENERGY STAR®. Refer to ENERGYSTAR.gov for more information on the ENERGY STAR® program.



MANUEL D'UTILISATION

Sécurité et références

TÉLÉVISEUR DEL*

*Les téléviseurs DEL de LG sont dotés d'écrans ACL avec rétroéclairage DEL.

Veillez lire ce manuel attentivement avant d'utiliser l'appareil et conservez-le pour pouvoir vous y reporter ultérieurement.

24LH4830

www.lg.com

Table des matières

3 Directives de sécurité importantes

7 Licences

7 Informations sur les logiciels libres

7 Préparation

8 Soulèvement et déplacement du téléviseur

8 Installation du téléviseur

8 Utilisation du bouton de la manette

8 Fonctions de base

9 Réglage du menu

9 Montage sur une table

9 Utilisation du système de sécurité Kensington (facultatif)

10 Montage mural

11 Connexions (Notifications)

11 Raccordement à une antenne ou au câble

11 Autres connexions

12 Télécommande

13 Dépannage

14 Caractéristiques

15 Réglementation

Directives de sécurité importantes

Conformez-vous toujours aux directives suivantes pour éviter des situations dangereuses et assurer le rendement optimal de votre appareil.



AFIN DE RÉDUIRE LE RISQUE D'ÉLECTROCUTION, NE RETIREZ PAS LE COUVERCLE (OU LE PANNEAU ARRIÈRE). AUCUNE PIÈCE POUVANT ÊTRE RÉPARÉE PAR L'UTILISATEUR NE SE TROUVE À L'INTÉRIEUR DE L'APPAREIL. FAITES APPEL À DU PERSONNEL D'ENTRETIEN QUALIFIÉ.

 Le symbole d'éclair avec une flèche, dans un triangle équilatéral, a pour fonction d'alerter l'utilisateur de la présence d'une « tension dangereuse » non isolée à l'intérieur du boîtier de l'appareil et qui pourrait être d'une puissance suffisante pour causer une électrocution.

 Le point d'exclamation dans un triangle équilatéral est conçu pour alerter l'utilisateur de la présence d'instructions importantes d'utilisation et d'entretien dans la documentation accompagnant l'appareil.

AVERTISSEMENT/MISE EN GARDE
- AFIN DE RÉDUIRE LE RISQUE D'INCENDIE ET D'ÉLECTROCUTION, N'EXPOSEZ PAS CE PRODUIT À LA PLUIE OU À L'HUMIDITÉ.

AVERTISSEMENT

Si vous ignorez le message d'avertissement, vous pourriez vous blesser gravement ou causer un accident ou un décès.

MISE EN GARDE

Si vous ignorez le message de mise en garde, vous pourriez vous blesser légèrement ou endommager le produit.

REMARQUE

Une lecture attentive de ce message avant utilisation vous permet de mieux comprendre le produit et de l'utiliser de façon sécuritaire.

Lisez ces directives.
Conservez ces directives.
Soyez attentif à tous les avertissements.
Suivez toutes les directives.



- N'utilisez pas cet appareil près de l'eau.



- Nettoyez uniquement avec un linge sec.



- Ne bloquez pas les orifices de ventilation. Installez le produit en respectant les directives du fabricant.



- N'installez pas le produit près de sources de chaleur comme les radiateurs, les bouches de chaleur, les fours et tout autre appareil (y compris les amplificateurs) produisant de la chaleur.



- Ne contournez pas le mécanisme de sécurité de la fiche polarisée ou de mise à la terre. Une fiche polarisée a deux lames, l'une d'elles étant plus large que l'autre. Une fiche de mise à la terre comporte deux lames et une troisième broche de mise à la terre. La lame plus large ou la troisième broche sont fournies pour votre sécurité. Si la fiche fournie ne s'insère pas dans votre prise, consultez un électricien afin de faire remplacer la prise désuète.



- Protégez le cordon d'alimentation de manière à ce qu'il ne soit ni piétiné ni pincé, particulièrement au niveau de la fiche, des prises de courant et à l'emplacement de sortie du cordon sur l'appareil.



- N'utilisez que les articles connexes ou accessoires recommandés par le fabricant.



- Utilisez uniquement avec un chariot, un pied, une fixation ou une table recommandé par le fabricant ou vendu avec l'appareil. Lorsqu'un chariot est utilisé, faites preuve de prudence lors du déplacement du chariot et de l'écran afin de prévenir les blessures causées par un basculement.



- Débranchez cet appareil pendant les orages ou lorsqu'il n'est pas utilisé pendant de longues périodes.



- Laissez le personnel qualifié se charger de tous les services d'entretien. Faites appel à un fournisseur de services d'entretien lorsque l'appareil a été endommagé d'une quelconque façon, notamment si la fiche ou le cordon d'alimentation est endommagé, si une substance liquide a été déversée sur l'appareil, si des objets sont tombés dans l'appareil, si l'appareil a été exposé à la pluie ou à l'humidité, s'il cesse de fonctionner correctement ou s'il a été échappé.



- Évitez d'appuyer fortement sur l'écran avec une main ou un objet pointu, comme un ongle, un crayon ou un stylo, et évitez d'égratigner l'écran.



- N'insérez aucun objet métallique ou conducteur dans le câble d'alimentation. Ne touchez pas l'extrémité du cordon d'alimentation lorsqu'il est branché.
- Gardez le matériel anti-humidité et le matériel d'emballage en vinyle hors de la portée des enfants. Le matériel anti-humidité est dangereux pour la santé s'il est avalé. S'il est avalé, provoquez un vomissement et rendez-vous à l'hôpital le plus près. De plus, le matériel d'emballage en vinyle peut entraîner la suffocation. Gardez-le hors de la portée des enfants.

- **AVERTISSEMENT** relatif au cordon d'alimentation (peut varier selon le pays) : Consultez la page des caractéristiques du présent guide d'utilisation pour vous en assurer. Ne branchez pas un trop grand nombre d'appareils dans une même prise d'alimentation c.a., car cela pourrait causer un incendie ou une électrocution. Ne surchargez pas les prises de courant murales. Les prises de courant murales surchargées, les prises de courant murales ou rallonges desserrées ou endommagées, les cordons d'alimentation effilochés ou endommagés et les revêtements de fil fissurés sont dangereux. Chacune de ces conditions peut entraîner des décharges électriques ou provoquer un incendie. Examinez périodiquement le cordon de votre appareil, et si son apparence indique des dommages ou une détérioration, débranchez-le, cessez d'utiliser l'appareil et faites remplacer le cordon par une pièce de remplacement exacte auprès d'un fournisseur de services d'entretien autorisé. Protégez le cordon d'alimentation contre les dommages physiques ou mécaniques. Veillez notamment à ce qu'il ne soit pas tordu, déformé, pincé, coincé dans une porte ou piétiné. Soyez particulièrement attentif aux fiches, aux prises de courant murales et à l'emplacement de sortie du cordon sur l'appareil. Ne déplacez pas le téléviseur si le cordon d'alimentation est branché. N'utilisez pas un cordon d'alimentation endommagé ou desserré. Assurez-vous de saisir la fiche lorsque vous débranchez le cordon d'alimentation. Ne tirez pas sur le cordon d'alimentation pour débrancher le téléviseur.



- **Avvertimento** - Afin de réduire le risque d'incendie ou d'électrocution, n'exposez pas ce produit à la pluie, à l'humidité ou à d'autres liquides. Ne touchez pas le téléviseur si vos mains sont mouillées. N'installez pas ce produit près d'objets inflammables comme de l'essence ou des chandelles, et n'exposez pas le téléviseur directement à l'air conditionné.



- Le moniteur ne doit être exposé à aucune vaporisation ni éclaboussure, et vous devez éviter de poser des objets remplis de liquide, comme des vases ou des tasses sur ou au-dessus de l'appareil (p. ex. sur des tablettes au-dessus de l'appareil).



• Mise à la terre

- (Sauf pour les appareils non mis à la terre)
Assurez-vous de brancher le fil de mise à la terre afin de prévenir tout risque d'électrocution (p. ex., un téléviseur doté d'une fiche c.a. à trois broches avec mise à la terre devrait être branché dans une prise électrique murale c.a. avec mise à la terre). Si la mise à la terre n'est pas possible, un électricien doit installer un disjoncteur de circuit pour la prise. Ne tentez pas de mettre à la terre l'appareil en le raccordant à des câbles téléphoniques, à un paratonnerre ou à des canalisations de gaz.

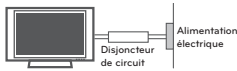

- Tant que cet appareil est branché dans la prise de courant murale c.a., il n'est pas déconnecté de la source d'alimentation c.a. même s'il est mis hors tension.
- Ne pas tenter de modifier cet appareil d'aucune manière sans avoir obtenu au préalable l'autorisation écrite de LG Electronics. Une modification non autorisée pourrait annuler l'autorisation de l'utilisateur d'utiliser cet appareil.

• Mise à la terre d'antennes extérieures

- (peut varier selon le pays) :
Si une antenne extérieure est installée, suivez les précautions ci-dessous. Un système d'antennes extérieures ne devrait pas se trouver à proximité des lignes aériennes d'électricité, d'autres éclairages électriques ou de circuits d'alimentation, ou à un endroit où il peut entrer en contact avec de telles lignes électriques ou de tels circuits d'alimentation, puisque des blessures graves, voire la mort, pourraient se produire. Assurez-vous que le système d'antennes est mis à la terre afin de fournir une certaine protection contre les surtensions et les accumulations de charge d'électricité statique. La section 810 du Code national de l'électricité (NEC) aux États-Unis fournit des renseignements relatifs à la procédure conforme de mise à la terre du mât et de la structure d'appui, du câble d'entrée à l'élément de sortie antenne, au format des fils de terre, à la position de l'élément de sortie antenne, au branchement des électrodes de terre, ainsi qu'aux exigences de mise à la terre de l'électrode.

• Mise à la terre de l'antenne en vertu du code électrique national, ANSI/NFPA 70

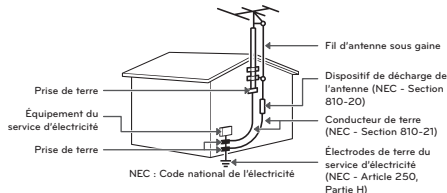

• Nettoyage

- Lors du nettoyage, débranchez le cordon d'alimentation et essuyez l'appareil avec un linge doux pour éviter de le rayer. Ne vaporisez pas d'eau ou d'autres liquides directement sur le téléviseur, car cela pourrait causer une électrocution. Ne nettoyez pas avec des produits chimiques comme de l'alcool, des solvants et du benzène.

• Déplacement

- Assurez-vous que l'appareil est hors tension, débranché et que tous les câbles ont été retirés. Deux personnes ou plus peuvent être requises pour transporter les téléviseurs d'une certaine taille. N'appliquez aucune pression (provenant de vous-même ou d'un élément extérieur) sur le panneau avant du téléviseur.

• Ventilation

- Installez votre téléviseur à un endroit où la ventilation est suffisante. N'installez pas votre appareil dans un espace confiné comme une bibliothèque. Ne couvrez pas ce produit d'un drap ou d'autres matériaux lorsqu'il est branché. N'installez pas dans un endroit excessivement poussiéreux.

- Si vous sentez une odeur de fumée ou d'autres odeurs provenant du téléviseur, débranchez le cordon d'alimentation et communiquez avec un centre de services autorisé.
- Si de l'eau ou toute autre substance s'infiltré dans le produit (p. ex. un adaptateur c.a., un cordon d'alimentation ou un téléviseur), débranchez le cordon d'alimentation et communiquez avec le centre de service immédiatement. Dans le cas contraire, cela peut provoquer un incendie ou une décharge électrique.



- Utilisez un adaptateur c.a. autorisé et un cordon d'alimentation approuvé par LG Electronics. Dans le cas contraire, cela peut provoquer un incendie, une décharge électrique, un mauvais fonctionnement ou une altération du produit.

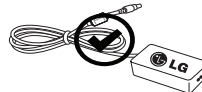

- Ne démontez jamais l'adaptateur c.a. ou le cordon d'alimentation. Cela peut provoquer un incendie ou une décharge électrique.



- Manipulez l'adaptateur avec soin pour éviter de l'échapper ou de le frapper. Un impact pourrait l'endommager.

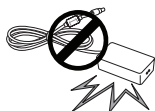

- Évitez que le produit soit exposé à la lumière solaire directe.
- Ne touchez jamais cet appareil ou cette antenne pendant un orage.
- Lors du montage du téléviseur au mur, assurez-vous de ne pas le suspendre à l'aide du câble de signal ou d'alimentation se trouvant à l'arrière du téléviseur.
- Évitez de heurter l'appareil et assurez-vous qu'aucun objet ne tombe dans celui-ci ou n'entre en contact avec l'écran.
- **DÉBRANCHER L'APPAREIL DE LA SOURCE D'ALIMENTATION PRINCIPALE**
La fiche d'alimentation est le dispositif de déconnexion. La fiche d'alimentation doit demeurer entièrement accessible afin de pouvoir débrancher l'appareil en cas d'urgence.
- Assurez-vous que le cordon d'alimentation est correctement branché dans la fiche d'alimentation électrique du téléviseur.

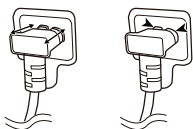

- **Piles**
Assurez-vous de ranger les accessoires (piles, etc.) dans un lieu sûr et hors de portée des enfants.
- Cet appareil fonctionne avec des piles. Il est possible que les règlements de votre communauté en matière d'environnement vous obligent à mettre ces piles au rebut en respectant certaines règles. Veuillez communiquer avec les autorités locales pour plus de renseignements sur la mise au rebut ou le recyclage des piles usagées.
- Ne jetez pas les piles dans le feu.
- Ne court-circuitez pas les piles, ne les démontez pas et ne les laissez pas surchauffer.
- N'utilisez pas d'équipement électrique à haute tension près du téléviseur (comme un tueur-mouches électrique). Cela pourrait entraîner un mauvais fonctionnement du produit.
- **Défauts de points**
 - Le panneau est un produit de haute technologie présentant une résolution de 2 à 6 millions de pixels. Dans de rares cas, on pourrait voir de petits points sur l'écran lors du visionnement. Ces points sont des pixels désactivés ne nuisant pas au rendement ni à la fiabilité du téléviseur.

• Son produit

- **Craquement** Un craquement survenant pendant le visionnement ou lors de l'arrêt du téléviseur est produit par une contraction thermique plastique causée par la chaleur ou l'humidité. Ce bruit est courant dans les produits où une déformation thermique est requise.
- **Bourdonnement de circuit ou de panneau électrique** Un bruit très faible est produit par un circuit commutateur haute vitesse fournissant une grande quantité de courant pour faire fonctionner un appareil. Il varie selon l'appareil. Ce son ne nuit aucunement au rendement ou à la fiabilité de l'appareil.
- Prenez soin de ne pas toucher aux ouvertures de ventilation. Lorsque le téléviseur fonctionne pendant de longues périodes, les ouvertures de ventilation peuvent devenir chaudes. Cela ne nuit aucunement au rendement de l'appareil et ne l'endommage pas.
- N'installez pas ce produit sur un mur où il pourrait être exposé à de l'huile ou à un brouillard d'huile puisque cela peut l'endommager et provoquer sa chute.
- Si le téléviseur est froid au toucher, il peut y avoir un léger « sautillerment » quand on l'allume. Cela est normal; le téléviseur n'est pas défectueux. De petits défauts de points peuvent être visibles à l'écran, apparaissant comme de petites taches rouges, vertes ou bleues. Toutefois, ils ne produisent aucun effet indésirable sur le rendement du téléviseur. Évitez de toucher l'écran ACL ou de mettre vos doigts dessus pendant une longue période de temps. Cela pourrait produire un effet de distorsion à l'écran.
- L'affichage d'une image fixe pendant une longue période peut entraîner l'incrustation de l'image. Évitez de laisser une image fixe affichée à l'écran pendant une période prolongée.

Licences

Les licences prises en charge peuvent différer selon le modèle. Pour plus de renseignements sur les licences, visitez le site www.lg.com.



Informations sur les logiciels libres

Pour obtenir le code source conformément aux dispositions de la licence publique générale, de la licence publique générale limitée, de la licence publique Mozilla et de toute autre licence régissant les logiciels à code source libre contenus dans cet appareil, visitez le site <http://opensource.lge.com>.

En plus du code source, toutes les dispositions de licence, les exonérations de garantie et les avis de droits d'auteurs peuvent aussi être téléchargés. LG Electronics mettra également à votre disposition le code source libre sur CD-ROM pour un prix couvrant le coût de la distribution (coût du support, de l'expédition et de la manutention) sur simple demande par courriel à l'adresse opensource@lge.com. Cette offre est valable pendant trois (3) années à compter de la date d'achat du produit.

Préparation

REMARQUES

- Lorsque vous allumez le téléviseur pour la première fois après qu'il ait été expédié depuis l'usine, son initialisation peut prendre quelques minutes.
- Les illustrations peuvent ne pas correspondre à votre téléviseur.
- L'afficheur (OSD) de votre téléviseur peut différer légèrement de l'illustration du présent manuel.
- Les menus et options disponibles peuvent différer en fonction de la source d'entrée ou du modèle d'appareil que vous utilisez.
- De nouvelles fonctionnalités pourraient être ajoutées à ce téléviseur à l'avenir.
- Les articles fournis avec votre produit peuvent varier selon le modèle.
- Les caractéristiques du produit ou le contenu de ce manuel peuvent être modifiés sans préavis pour refléter la mise à niveau des fonctions du produit.
- Pour que la connexion soit optimale, les connecteurs des câbles HDMI et des dispositifs USB devraient avoir un rebord de moins de 10 mm (0,39 po) d'épaisseur et de moins de 18 mm (0,7 po) de largeur.
- Si le câble ou la clé USB ne rentre pas dans le port USB de la télé, servez-vous d'un câble de rallonge compatible USB 2.0.
- Utilisez un câble certifié portant le logo HDMI. Si vous n'utilisez pas un câble HDMI certifié, l'écran peut ne pas s'afficher ou un problème de connexion peut se produire.
- Types de câbles HDMI recommandés
 - Câble HDMI®/™ haute vitesse
 - Câble HDMI®/™ haute vitesse avec Ethernet

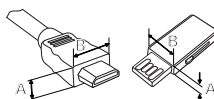

*A ≤ 10 mm (0,39 po)

*B ≤ 18 mm (0,7 po)

- Ce téléviseur intelligent est conçu pour le service de vidéo à la demande; certaines fonctions intelligentes peuvent ne pas être prises en charge, y compris le navigateur Web.

MISE EN GARDE

- Afin de garantir la sécurité et la durée de vie de l'appareil, n'utilisez pas d'articles non approuvés.
- Tout dommage ou blessure causé par l'utilisation d'un article non approuvé n'est pas couvert par la garantie.
- Certains modèles ont une fine pellicule apposée sur l'écran. Celle-ci fait partie du téléviseur; il ne faut pas la retirer.

- Pour fixer le support au téléviseur, placez l'écran face vers le bas sur une table ou une surface plane matelassée afin de le protéger contre les rayures.

Soulèvement et déplacement du téléviseur

Lorsque vous désirez déplacer ou soulever le téléviseur, lisez tout d'abord ce qui suit pour éviter d'égratigner ou d'endommager le téléviseur, ainsi que pour effectuer un transport sécuritaire sans égard au type et à la taille du téléviseur.

- Il est recommandé de déplacer le téléviseur en utilisant la boîte ou le matériel d'emballage dans lequel a été livré le téléviseur à l'origine.
- Avant de déplacer ou de soulever le téléviseur, débranchez le cordon d'alimentation et tous les câbles.
- Lorsque vous manipulez le téléviseur, vous devriez l'orienter pour que l'écran ne soit pas de votre côté pour éviter de l'endommager.
- Tenez fermement le haut et le bas du cadre du téléviseur. Assurez-vous de ne pas tenir la partie transparente, le haut-parleur ou la grille de haut-parleur du téléviseur.

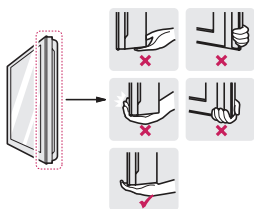

- Lorsque vous transportez le téléviseur, évitez de l'exposer à des chocs ou à des vibrations excessives.
- Lorsque vous transportez le téléviseur, maintenez-le à la verticale; ne le tournez jamais sur le côté et ne le penchez pas à gauche ou à droite.
- Lors de la manipulation du téléviseur, veillez à ne pas endommager les boutons en saillie.

⚠ MISE EN GARDE

- Évitez de toucher à l'écran puisque cela pourrait causer des dommages à celui-ci.
- Ne déposez pas la partie avant du produit directement sur le sol sans coussinage. Cela pourrait endommager l'écran.

Installation du téléviseur

⚠ MISE EN GARDE

- Ne transportez pas le téléviseur à l'envers, car il pourrait se détacher de son support, ce qui pourrait l'endommager ou provoquer des blessures.
- Lors de la fixation du support, posez le téléviseur, écran vers le bas, sur une table matelassée ou une surface plane pour prévenir les risques de rayures.

! REMARQUES

- Soulevez le loquet de la partie inférieure de la base du support et retirez la base du téléviseur.

Utilisation du bouton de la manette

(L'illustration peut ne pas correspondre à votre téléviseur.)

Vous pouvez commander le téléviseur en appuyant sur le bouton ou en déplaçant la manette vers la gauche, la droite, le haut ou le bas.

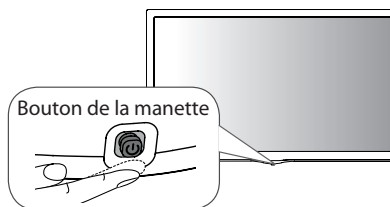





Fonctions de base

	Mise sous tension (appuyez) Mise hors tension (maintenez enfoncé) ¹
	Réglage du volume
	Réglage des chaînes

¹ Si le bouton menu est affiché à l'écran, vous pourrez quitter le menu en appuyant et en maintenant enfoncé le bouton de la manette.

Réglage du menu

Lorsque le téléviseur est allumé, appuyez une fois sur le bouton. Vous pouvez régler les éléments du menu en appuyant sur les boutons ou en les faisant bouger.

	Met l'appareil hors tension.
	Permet d'accéder au menu principal.
	Efface ce qui est affiché à l'écran et retourne au visionnement de la télévision.
	Change de source d'entrée.

! REMARQUES

- Si vous appuyez sur le bouton en premier, il se peut que vous ne puissiez pas régler le volume ni parcourir les chaînes enregistrées.

! MISE EN GARDE

- Lorsque vous déplacez le bouton de la manette vers le haut, le bas, la gauche ou la droite, prenez garde de ne pas l'enfoncer.

Montage sur une table

- 1 Soulevez et inclinez le téléviseur dans sa position verticale sur une table.
- Laissez au minimum un espace de 100 mm (3,9 po) entre le mur et le téléviseur pour une ventilation adéquate.

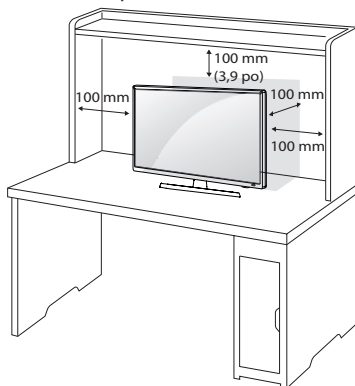

- 2 Raccordez le cordon d'alimentation à une prise murale.

! MISE EN GARDE

- Ne placez pas le téléviseur près ou sur des sources de chaleur, car cela peut causer un incendie ou d'autres dommages.

Utilisation du système de sécurité Kensington (facultatif)

(Selon le modèle)

Le connecteur du système de sécurité Kensington se trouve à l'arrière du téléviseur. Pour de plus amples renseignements sur l'installation et l'utilisation de ce système, reportez-vous au manuel fourni avec le système de sécurité Kensington ou visitez le site Web <http://www.kensington.com>.

Connectez le câble du système de sécurité Kensington au téléviseur et à une table.

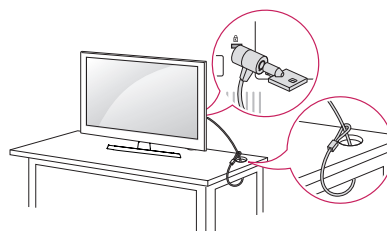

! REMARQUES

- Le système de sécurité Kensington est facultatif. Vous pouvez obtenir des accessoires supplémentaires auprès de votre détaillant local.

Montage mural

Une fixation murale optionnelle peut être utilisée pour installer votre téléviseur LG. Consultez votre fournisseur local afin de trouver une fixation murale qui correspond aux normes VESA de votre modèle de téléviseur. Posez soigneusement le support de fixation murale au dos de votre téléviseur. Installez-le sur un mur solide qui est perpendiculaire au sol. Si vous posez le téléviseur sur d'autres matériaux de construction, veuillez communiquer avec le personnel qualifié pour installer la fixation murale. Des directives détaillées seront comprises avec la fixation murale. Nous vous recommandons d'utiliser une fixation murale de marque LG. La fixation murale de LG est facile à ajuster et les câbles s'y branchent aisément. Si vous n'utilisez pas une fixation murale de LG, utilisez un support permettant de poser l'appareil au mur de façon sécuritaire et offrant suffisamment d'espace pour la connexion des appareils externes. Si vous utilisez une fixation non réglable, posez-la sur le mur. Branchez d'abord les câbles sur le téléviseur, puis placez le téléviseur sur la fixation murale.

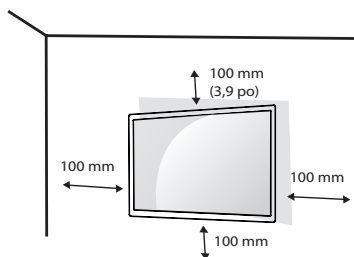

Assurez-vous d'utiliser les vis et les fixations murales qui répondent aux normes VESA. Les dimensions standards des trousse de fixation murale sont indiquées dans le tableau suivant.

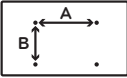
Modèle	24LH4830
VESA (A x B)	75 x 75
	
Vis standard	M4
Nombre de vis	4
Fixation murale (facultative)	RW120

⚠ MISE EN GARDE

- Débranchez le câble d'alimentation avant de déplacer ou d'installer le téléviseur, car cela pourrait causer une électrocution.
- Retirez le support avant d'installer le téléviseur sur une fixation murale en fixant le support à l'envers.
- Si vous installez le téléviseur sur un plafond ou un mur incliné, il peut tomber et causer de graves blessures. Utilisez une fixation murale autorisée par LG et communiquez avec le détaillant local ou le personnel qualifié.
- Ne serrez pas trop les vis, car cela pourrait endommager le téléviseur et annuler votre garantie.
- Utilisez uniquement des vis et des fixations murales qui répondent aux normes VESA. Tout dommage ou toute blessure découlant d'un usage abusif ou de l'utilisation d'un accessoire inapproprié n'est pas couvert par la garantie.
- La longueur de la vis depuis la surface externe du couvercle arrière doit être inférieure à 8 mm (0,3 po).

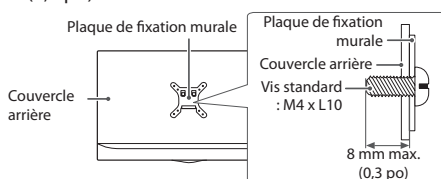

! REMARQUES

- Utilisez uniquement des vis qui sont répertoriées dans les caractéristiques de la norme VESA.
- La trousse de fixation murale comprend un manuel d'installation et les pièces nécessaires.
- Le support mural est disponible en option. Vous pouvez obtenir des accessoires supplémentaires auprès de votre détaillant local.
- La longueur des vis peut varier selon la fixation murale. Assurez-vous d'utiliser la longueur appropriée.
- Pour de plus amples renseignements, reportez-vous au manuel livré avec la fixation murale.

Connexions (Notifications)

Vous pouvez brancher différents appareils sur le téléviseur. Sont pris en charge les récepteurs HD, les lecteurs DVD, les magnétoscopes, les systèmes audio, les dispositifs de stockage USB, les ordinateurs, les consoles de jeu et d'autres périphériques externes. Pour plus de renseignements sur la connectivité des appareils externes, consultez le manuel fourni avec chaque appareil.

! REMARQUES

- Si vous enregistrez un programme télévisé à l'aide d'un enregistreur de DVD ou d'un magnétoscope, assurez-vous de brancher le câble de signal d'entrée au téléviseur par l'intermédiaire de l'enregistreur ou du magnétoscope. Pour en savoir davantage sur l'enregistrement, reportez-vous au manuel fourni avec le périphérique connecté.
- La connexion de l'appareil externe peut différer légèrement des illustrations présentées dans le manuel.
- Connectez les appareils externes au téléviseur indépendamment de l'ordre du port TV.
- Si vous branchez une console de jeu au téléviseur, utilisez le câble fourni avec la console.
- Reportez-vous au manuel de l'équipement externe pour obtenir les instructions de fonctionnement.
- En mode PC, un bruit peut être émis relativement à la résolution, au motif vertical, au contraste ou à la luminosité. Si vous entendez du bruit, changez la résolution de la sortie PC, changez la fréquence de rafraîchissement, ou réglez la luminosité et le contraste dans le menu **IMAGE** pour obtenir une image nette.
- Selon votre carte graphique, il est possible que certains réglages de résolution ne permettent pas le positionnement correct de l'image sur l'écran.

Raccordement à une antenne ou au câble

Pour regarder la télévision, raccordez le téléviseur à une antenne, au câble ou à un décodeur de câblodistribution. Les illustrations peuvent différer des articles réels et l'utilisation d'un câble RF est facultative.

! MISE EN GARDE

- Assurez-vous de ne pas plier le fil de cuivre du câble RF.



- Pour éviter d'endommager votre téléviseur, faites d'abord tous les branchements entre les appareils, puis branchez le cordon d'alimentation dans la prise d'alimentation.

! REMARQUES

- Utilisez un dispositif d'aiguillage de signaux pour utiliser deux téléviseurs ou plus.
- Codecs audio TVN pris en charge : MPEG, Dolby Digital.

Autres connexions

Branchez votre téléviseur à des appareils externes. Pour obtenir l'image et le son de la meilleure qualité, reliez l'appareil externe et le téléviseur au moyen d'un câble HDMI, comme indiqué. Selon le modèle, un câble pourrait être fourni.

Télécommande

Les descriptions qui se trouvent dans le présent manuel font référence aux touches qui se trouvent sur la télécommande. Veuillez lire le présent manuel attentivement et utiliser le téléviseur correctement. Pour installer les piles, ouvrez le couvercle de leur compartiment et insérez les piles (AAA de 1,5 V) en faisant correspondre leurs bornes (+) et (-) à celles du compartiment, puis remettez le couvercle en place. Le non-respect des polarités de la pile pourrait causer l'explosion de la pile ou une fuite et entraîner un incendie, des blessures corporelles ou un risque de pollution pour l'environnement. Pour retirer les piles, suivez le processus d'installation dans l'ordre inverse. Cette télécommande fonctionne au moyen de la lumière infrarouge. Assurez-vous d'orienter la télécommande vers le capteur de télécommande du téléviseur.

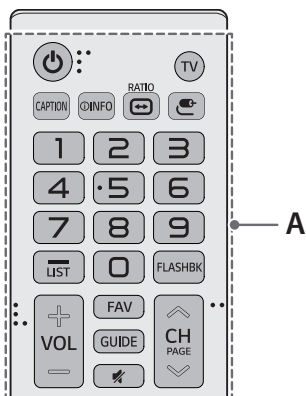

A

⏻ (Marche/Arrêt) Allume ou éteint le téléviseur.

TV Permet de retourner à la dernière chaîne de télévision.

CAPTION Active ou désactive les sous-titres.

ⓘ INFO Affiche des données sur l'émission en cours.

⏏ RATIO Redimensionne une image.

⏏ (Entrée) Sélectionne le mode de signal d'entrée.

Touches numériques Permettent d'entrer des chiffres.

— (Tiret) Insère un tiret entre des chiffres, comme 2-1 et 2-2.

LIST Affiche la liste des chaînes enregistrées.

FLASHBK Permet d'alterner entre les deux dernières chaînes sélectionnées (en appuyant de façon répétée).

+ VOL — Règle le volume.

FAV Affiche la liste de vos chaînes favorites.

GUIDE Affiche l'événement de programme en fonction du programmeur de temps.

🔇 (Sourdine) Désactive tous les sons.

⏪ CH ⏩ Parcourt les chaînes enregistrées.

⏪ PAGE ⏩ Affiche l'écran précédent ou suivant.

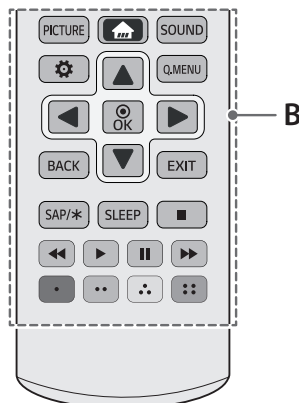

B

PICTURE Modifie le mode image.

🏠 (Home) Permet d'accéder au menu d'accueil.

SOUND Modifie le mode audio.

⚙️ (Paramètres) Permet d'accéder aux paramètres.

Q.MENU Permet d'accéder aux raccourcis.

Touches de navigation (haut, bas, gauche, droite) Permettent de faire défiler les menus ou les options.

⊙ OK Permet de sélectionner des menus ou des options et de confirmer votre choix.

BACK Permet de revenir à l'écran précédent.

EXIT Supprime tout ce qui est affiché à l'écran et permet de revenir au visionnement de la télévision.

SAP/* Permet d'activer la fonction SAP (Secondary Audio Program (seconde piste audio)). (Selon le modèle)

SLEEP Permet de programmer l'arrêt du téléviseur après un certain délai.

⏮ ⏪ ⏸ ⏩ ⏭ Touches de commande pour la lecture du contenu multimédia

Touches de couleur (🔴 Rouge, 🟢 Vert, 🟡 Jaune, 🔵 Bleu) Permettent d'accéder à diverses fonctions de certains menus.

Dépannage

- La télécommande ne fonctionne pas.
 - Assurez-vous que rien n'a été placé sur le récepteur (du ruban adhésif, par exemple).
 - Vérifiez qu'aucun obstacle n'empêche la communication entre l'appareil et la télécommande.
 - Remplacez les piles par de nouvelles.
- Le téléviseur ne produit pas d'images ni de son.
 - Vérifiez que le téléviseur est allumé.
 - Vérifiez que le cordon d'alimentation est branché dans une prise murale.
 - Vérifiez que la prise murale fonctionne en y branchant d'autres appareils.
- Le téléviseur s'éteint brusquement.
 - Vérifiez les réglages de l'alimentation. Il y a peut-être eu une coupure de courant.
 - Vérifiez si la fonction de **Mise en arrêt/Minuterie a été** activée dans les réglages **HEURE**.
 - En l'absence de signal, le téléviseur s'éteint automatiquement au bout de 15 minutes d'inactivité.

Caractéristiques

Les caractéristiques techniques des produits peuvent être modifiées sans préavis en raison de mises à niveau des fonctions de produits. La consommation d'énergie annuelle estimée indiquée sur l'étiquette FTC est mesurée conformément aux procédures de test pour les téléviseurs (États-Unis seulement). La consommation d'énergie réelle dépend de l'environnement d'utilisation (le contenu regardé, les réglages du téléviseur, etc.).

FRANÇAIS

Modèle	Dimensions (L x H x P)		Poids		Consommation électrique (Conditions par défaut)	Alimentation
	Avec support	Sans support	Avec support	Sans support		
24LH4830	556 x 387,3 x 146,3 (mm)	556 x 345,2 x 53,1 (mm)	3,4 (kg)	3,2 (kg)	24 W	19 V --- 2,0 A
	21,8 x 15,2 x 5,7 (po)	21,8 x 13,5 x 2,0 (po)	7,4 (lb)	7,0 (lb)		

Adaptateur c.a./c.c.	Fabricant : Lien Chang Modèle : LCAP16B-A
	Fabricant : Honor Modèle : ADS-45FSN-19 19040GPCU
Entrée : c. a 100 – 240 V ~ 50/60 Hz Sortie : c.c. 19 V --- 2,1 A	

Conditions d'utilisation	Température de fonctionnement	De 0 °C à 40 °C (de 32 °F à 104 °F)
	Humidité de fonctionnement	Moins de 80 %
	Température d'entreposage	De -20 °C à 60 °C (de -4 °F à 140 °F)
	Humidité d'entreposage	Moins de 85 %

Système télévisuel	ATSC, NTSC-M, 64 et 256 QAM
Programmation	VHF 2-13, UHF 14-69, CATV 1-135, DTV 2-69, CADTV 1-135
Impédance de l'antenne externe	75 Ω

Caractéristiques du module du réseau local sans fil (WN8122E1)	
Standard	IEEE 802.11a/b/g/n
Gamme de fréquences	2 400 à 2 483,5 MHz 5 150 à 5 250 MHz 5 725 à 5 850 MHz
Puissance de sortie (maximale)	802.11a : 16,5 dBm 802.11b : 16 dBm 802.11g : 15,5 dBm 802.11n - 2,4 GHz : 15,5 dBm 802.11n - 5 GHz : 16,5 dBm
<ul style="list-style-type: none"> • Comme la bande de fréquence peut varier selon le pays, l'utilisateur ne peut pas changer ou régler la fréquence de fonctionnement. Ce produit est configuré conformément au tableau des fréquences régionales. • L'appareil doit être installé et doit fonctionner en conservant une distance minimale de 20 cm (7,8 po) entre celui-ci et l'utilisateur. • Code FCC ID : BEJWN8122E1/Code IC : 2703H-WN8122E1 	

Réglementation

Renseignements relatifs à la réglementation FCC

(Pour les États-Unis)

Cet équipement a été testé et jugé conforme aux limites relatives aux appareils numériques de catégorie B imposées par le paragraphe 15 de la réglementation de la FCC. Ces limites sont établies afin d'offrir une protection raisonnable contre les interférences nuisibles dans une résidence. Cet équipement génère, utilise et peut diffuser de l'énergie de radiofréquences et, s'il n'est pas installé et utilisé conformément aux instructions, il peut causer des interférences nuisibles aux communications radio. Cependant, il n'existe aucune garantie qu'il n'y aura pas d'interférences dans une résidence particulière. Si cet équipement cause des interférences nuisibles à la réception radio ou télévision (pour s'en assurer, il suffit d'éteindre et de rallumer l'appareil), l'utilisateur est invité à essayer de corriger les interférences à l'aide de l'une ou de plusieurs des mesures suivantes :

- Réorienter ou déplacer l'antenne de réception;
- Augmenter la distance entre l'équipement et le récepteur;
- Brancher l'équipement sur un circuit électrique distinct de celui qui alimente le récepteur;
- Demander l'aide du distributeur ou d'un technicien qualifié en entretien et en réparation de matériel audio-vidéo.

Cet appareil est conforme aux limites imposées par le paragraphe 15 de la réglementation de la FCC. L'exploitation est autorisée aux deux conditions suivantes : (1) cet appareil ne doit pas provoquer de brouillage préjudiciable, et (2) cet appareil doit accepter toutes les interférences reçues, y compris celles pouvant causer un fonctionnement indésirable. Les modifications dans la fabrication de cet appareil qui ne sont pas expressément approuvées par l'autorité responsable de la conformité pourraient annuler l'autorisation accordée à l'utilisateur de faire fonctionner l'équipement.

Exigences de la FCC en matière d'interférences des fréquences radio (pour appareils UNII)

Les radars à haute puissance sont attribués comme utilisateurs principaux des bandes de fréquence 5,25 à 5,35 GHz et 5,65 à 5,85 GHz. Ces stations radars peuvent causer des interférences pour cet appareil ou l'endommager. Cet appareil ne peut être colocalisé avec tout autre émetteur.

Énoncé de la FCC sur l'exposition aux rayonnements RF

[Pour la fonction sans fil (WLAN, Bluetooth, etc.)]
Cet appareil est conforme aux limites d'exposition aux rayonnements de la FCC pour un environnement non contrôlé. Cet émetteur ne doit pas être colocalisé ni utilisé conjointement avec tout autre émetteur ou antenne. Cet appareil devrait être installé de façon à garder une distance minimale de 20 cm (7,8 po) entre l'antenne et l'utilisateur. Les utilisateurs doivent respecter les directives d'utilisation afin de satisfaire aux critères en matière d'exposition aux rayonnements RF.

Avis d'Industrie Canada

(Pour le Canada)

[Pour la fonction sans fil (WLAN, Bluetooth, etc.)]

Le présent appareil est conforme aux CNR d'Industrie Canada applicables aux appareils radio exempts de licence. L'exploitation est autorisée aux deux conditions suivantes :

1. L'appareil ne doit pas produire de brouillage.
2. L'utilisateur de l'appareil doit accepter tout brouillage radioélectrique subi, même si le brouillage est susceptible d'en compromettre le fonctionnement

Avis d'industrie Canada sur l'exposition aux rayonnements

(Pour le Canada)

[Pour la fonction sans fil (WLAN, Bluetooth, etc.)]

Cet appareil est conforme aux limites d'exposition aux rayonnements d'Industrie Canada pour un environnement non contrôlé. Cet appareil doit être installé de façon à garder une distance minimale de 20 cm (7,8 po) entre la source de rayonnement et l'utilisateur.

REMARQUE : LE FABRICANT N'EST PAS RESPONSABLE DES INTERFÉRENCES RADIOÉLECTRIQUES CAUSÉES PAR DES MODIFICATIONS NON AUTORISÉES APPORTÉES À CET APPAREIL. DE TELLES MODIFICATIONS POURRAIENT ANNULER L'AUTORISATION ACCORDÉE À L'UTILISATEUR DE FAIRE FONCTIONNER L'APPAREIL.

⚠ AVERTISSEMENT

(Pour le Canada)

[Pour un produit doté de la fonction sans fil utilisant la bande de fréquence de 5 GHz]

- Les dispositifs fonctionnant dans la bande de 5 150 à 5 250 MHz sont réservés uniquement pour une utilisation à l'intérieur afin de réduire les risques de brouillage préjudiciable aux systèmes de satellites mobiles utilisant les mêmes canaux.
- Pour les dispositifs avec une ou des antennes amovibles, le gain maximal d'antenne permis pour les dispositifs utilisant les bandes de 5 250 à 5 350 MHz et de 5 470 à 5 725 MHz doit être conforme à la limite de la p.i.r.e.
- Pour les dispositifs avec une ou des antennes amovibles, le gain maximal d'antenne permis (pour les dispositifs utilisant la bande de 5 725 à 5 850 MHz) doit être conforme à la limite de la p.i.r.e. spécifiée pour l'exploitation point à point et l'exploitation non point à point, selon le cas.
- Les pires angles d'inclinaison nécessaires pour rester conforme à l'exigence de la p.i.r.e. applicable au masque d'élévation, et énoncée dans l'article 6.2.2 (3), doivent être clairement indiqués. (dispositifs fonctionnant dans la bande de 5 250 à 5 350 MHz et dont la p.i.r.e. maximale dépasse 200 mW).
- Les utilisateurs de radars de haute puissance sont désignés utilisateurs principaux (c.-à-d., qu'ils ont la priorité) des bandes de 5 250 à 5 350 MHz et de 5 650 à 5 850 MHz. De plus, ces radars pourraient causer du brouillage ou des dommages aux dispositifs LAN-EL.

Remarque à l'intention des installateurs de réseaux câblés

(Pour les États-Unis et le Canada)

Cette remarque a pour but d'attirer l'attention des installateurs de réseaux câblés sur l'article 820-40 du Code national de l'électricité (NEC). Ce code donne des lignes directrices concernant la mise à la terre appropriée de tels réseaux et, en particulier, il précise que le câble doit être relié à l'installation de mise à la terre du bâtiment, et ce, aussi près que possible de son point d'entrée.







AVERTISSEMENT!

Ne placez jamais un téléviseur sur une surface instable. Le téléviseur pourrait tomber et causer des blessures importantes pouvant aller jusqu'à la mort. De nombreuses blessures, en particulier chez les enfants, peuvent être évitées en prenant des précautions simples comme :

- utiliser des armoires ou des supports recommandés par le fabricant du téléviseur;
- utiliser uniquement des meubles qui peuvent supporter le téléviseur de façon sécuritaire;
- s'assurer que le téléviseur ne dépasse pas le bord du meuble sur lequel il est installé;
- ne pas placer le téléviseur sur un meuble élevé (une armoire ou une bibliothèque, par exemple) sans ancrer le meuble et le téléviseur à un support adéquat;
- ne pas placer le téléviseur sur un tissu ou tout autre matériau inséré entre le téléviseur et le meuble sur lequel il est installé;
- informer les enfants des dangers que représente le fait de grimper sur un meuble pour atteindre le téléviseur ou ses commandes.

Si votre téléviseur actuel doit être déplacé, tenez compte des mêmes précautions.

Symboles

	Se rapporte au courant alternatif (c.a.).
	Se rapporte au courant continu (c.c.).
	Se rapporte à un appareil de classe II.
	Se rapporte à la mise en veille.
	Se rapporte à la mise en marche (alimentation).
	Se rapporte à une tension dangereuse.

LA SÉCURITÉ DES ENFANTS:

L'IMPORTANCE D'UN EMPLACEMENT APPROPRIÉ POUR LE TÉLÉVISEUR



L'INDUSTRIE DE L'ÉLECTRONIQUE GRAND PUBLIC EST SOUCIEUSE DE VOTRE SÉCURITÉ

- Les fabricants, les détaillants et l'industrie de l'électronique grand public dans son ensemble sont déterminés à faire en sorte que le divertissement domestique soit sûr et plaisant.
- Alors que vous vous divertissez devant la télévision, n'oubliez pas que tous les téléviseurs, neufs comme anciens, doivent être : soit positionnés sur un socle approprié, soit installés selon les recommandations spécifiques du fabricant. Les téléviseurs placés de façon non appropriée sur des commodes, des bibliothèques, des étagères, des bureaux, des haut-parleurs, des armoires, des chariots, etc. peuvent tomber et entraîner des blessures.



RESTER À L'ÉCOUTE DE LA SÉCURITÉ

- Respectez **TOUJOURS** les recommandations du fabricant pour une installation sûre de votre téléviseur.
- Lisez et suivez **TOUJOURS** toutes les instructions données pour un bon usage de votre téléviseur.
- Ne permettez **JAMAIS** aux enfants de grimper ou de jouer sur le téléviseur ou le meuble sur lequel le téléviseur est placé.
- Ne placez **JAMAIS** le téléviseur sur un meuble pouvant facilement être utilisé comme marche-pied, telle qu'une commode par exemple.
- Installez **TOUJOURS** le téléviseur à un endroit où il ne peut pas être poussé, tiré ou renversé.
- Faites **TOUJOURS** passer les prises et câbles connectés au téléviseur à un endroit où ils ne pourront pas faire trébucher quelqu'un ou encore où ils ne pourront pas être tirés ou attrapés.



FIXATION DU TÉLÉVISEUR SUR LE MUR OU LE PLAFOND

- Contactez **TOUJOURS** votre revendeur pour une installation professionnelle au moindre doute quant à votre capacité à fixer le téléviseur de manière sûre.
- Utilisez **TOUJOURS** un support recommandé par le fabricant du téléviseur et dont la sécurité a été certifiée par un laboratoire indépendant (tel que UL, CSA, ETL).
- Suivez **TOUJOURS** toutes les instructions fournies par les fabricants du téléviseur et du support.
- Assurez-vous **TOUJOURS** que le mur ou le plafond sur lequel vous fixez le téléviseur est approprié. Certains supports ne sont pas conçus pour être fixés aux murs ou aux plafonds ayant une armature en acier ou construits avec des parpaings. En cas de doute, contactez un installateur professionnel.
- Les téléviseurs peuvent être lourds. Deux personnes minimum sont nécessaires pour la fixation au mur ou au plafond.



DÉPLACER UN ANCIEN TÉLÉVISEUR DANS VOTRE MAISON

- Nombreuses sont les personnes déplaçant leur ancien téléviseur CRT dans une autre pièce de la maison après l'achat d'un téléviseur à écran plat. Une attention particulière doit être portée au nouvel emplacement d'un ancien téléviseur CRT.
- Placez **TOUJOURS** votre ancien téléviseur CRT sur un meuble solide et adapté à la taille et au poids du téléviseur.
- Ne placez **JAMAIS** votre ancien téléviseur CRT sur une commode dont les enfants sont susceptibles d'utiliser les tiroirs pour grimper.
- Assurez-vous **TOUJOURS** que votre ancien téléviseur CRT ne dépasse pas le bord de votre meuble.

CE.org/safety





Service à la clientèle LG

Pour toute question ou commentaire, visitez le www.lg.com ou appelez :

1-888-542-2623	CANADA
1-800-243-0000	États-Unis, résidentiel
1-888-865-3026	États-Unis, commercial

Enregistrez votre produit en ligne!

www.lg.com

Veillez noter que l'étiquette attachée au produit fournit des informations pour le soutien technique. Inscrivez-les ci-dessous au cas où vous auriez besoin d'un service d'entretien ou de réparation.

MODÈLE _____

NUMÉRO DE SÉRIE _____

Attestation de conformité

Nom commercial : LG

Modèle : 24LH4830

Partie responsable : LG Electronics inc.

Adresse : 1000, av. Sylvan, Englewood Cliffs, NJ 07632 É.-U.

Téléphone: 201 266-2534



Ce produit est conforme aux normes ENERGY STAR® lorsque le « réglage d'usine par défaut (Résidentiel) » est sélectionné. Modifier les réglages d'usine par défaut ou activer d'autres fonctionnalités augmente la consommation d'énergie qui pourrait alors dépasser les limites de la qualification ENERGY STAR®. Consultez le site ENERGYSTAR.gov pour en savoir plus au sujet du programme ENERGY STAR®.

KING || WiFiMax™

Wi-Fi Extender KWM 1000

(included with KS1000)



The KING WiFiMax creates your own private and secure Wi-Fi network, just like you have in your home. When in range of an available network, simply configure your WiFiMax to connect to that network, and it will extend the internet access from that network to your own private Wi-Fi network.

KING || SWIFT™

Omnidirectional Wi-Fi Antenna KS1000

(not included with KWM1000)



The KING Swift is an omnidirectional Wi-Fi antenna that increases the range and performance of your KING WiFiMax router and range extender. This 2.4GHz Wi-Fi antenna mounts to your roof, connects to your KING WiFiMax via a single cable, and allows your KING WiFiMax to connect to networks from even farther away and still utilize its 5GHz network for fastest speeds.

CONTENTS

CONTENTS	2
CONNECTIONS	3
FIRST-TIME SETUP	4-5
STANDARD OPERATION	6-9
INSTALLATION	10-11
TROUBLESHOOTING	12
SPECIFICATIONS	13
LIMITED WARRANTY	14
WIRELESS REGULATORY INFORMATION	15

CONTENTS

KING Wi-FiMax KWM1000

For increased performance, you can add a KING Swift (contact KING Customer Service at 952-345-8147).

Manual



Power Supply



Dipole Antenna



KING Wi-FiMax



NOTE: No tools are required to set up and use the KING Wi-FiMax (unless wall mounting the unit).

There are key hole slots on the back to mount the unit to a wall. The user must determine where and how to best mount the unit to a wall (inside use only).

KING Swift KS1000

Includes the KING Wi-FiMax and power supply shown above.

KING Swift antenna with preattached cable

Mounting bracket



White wall plate



Black wall plate



Watertight connector



Washer



Nut



Cable



NOTE: The KING Swift, bracket and hardware may come preassembled.

For complete installation instructions see page 10.

CONNECTIONS

Place your KING WiFiMax on a stable surface (or wall mount).

Make connections as shown.

- A** Attach included dipole antenna or cable from KING Swift to open port.
- B** Rotate antennas into vertical position (up and down).
- C** Connect to power.

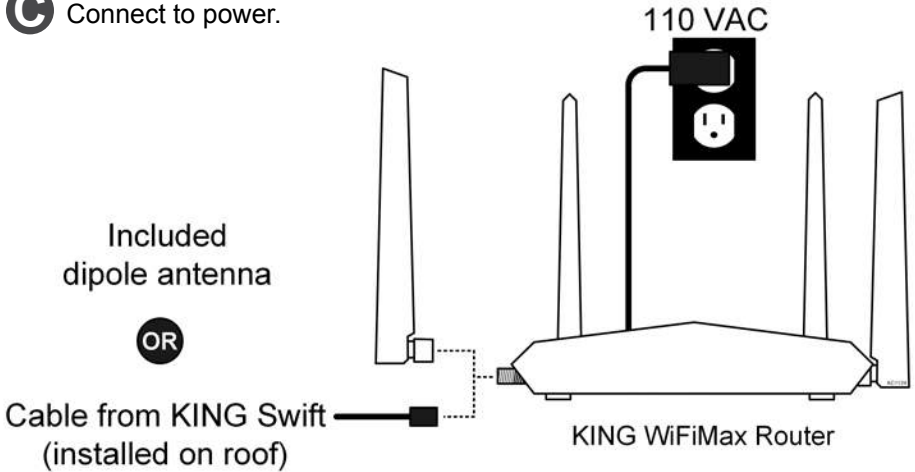

NOTE: You can use the keyhole slots on the back to wall mount the unit.

ANTENNAS MUST ALWAYS BE VERTICAL (UP AND DOWN).

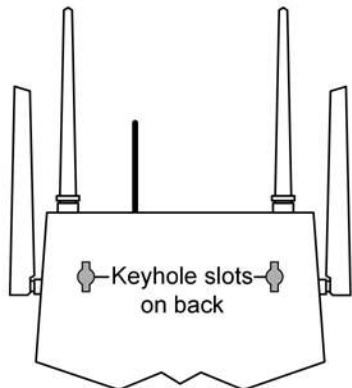
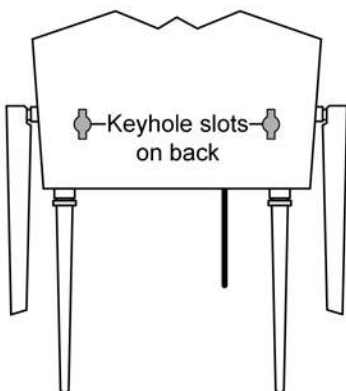

FIRST-TIME SETUP

NOTE: If you have already completed first-time setup, go to page 6.

WHICH NETWORK TO CHOOSE:

KING_XXXXXX_5G is the 5GHz network and is faster than **KING_XXXXXX** which is the 2.4GHz network.

“XXXXXX” will be a set of numbers and letters unique to your router.

Choose the 5GHz network when possible.

NOTE: Some older devices may not have the ability to receive the 5GHz network, and therefore you may not see the 5GHz option.

1. Go to your phone, tablet or computer's settings page and connect to the Wi-Fi network.

KING_XXXXXX_5G

If you cannot connect to **KING_XXXXXX_5G**, connect to

KING_XXXXXX



Graphics will vary.

2. Open your device's web browser.

Go to: **<http://mykingwifi.com>**

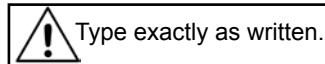

Type exactly as written.

This screen should appear. Tap “WiFi Settings” in the left-hand column.

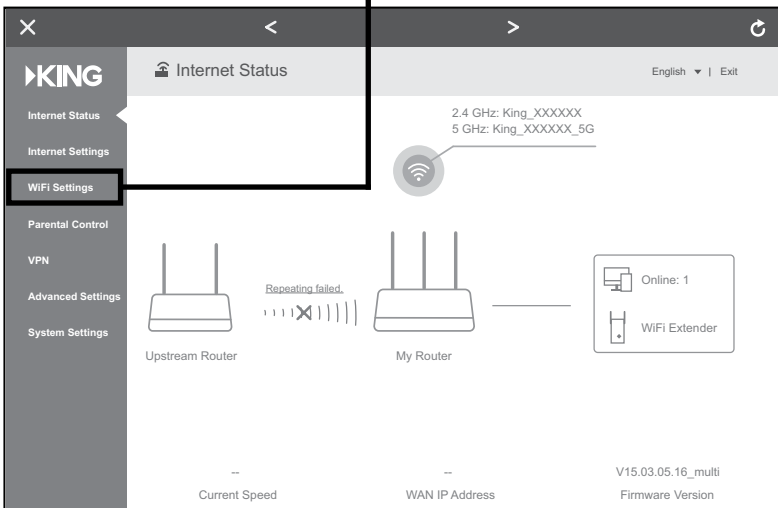

3. This screen should appear. Tap “WiFi Name & Password.”

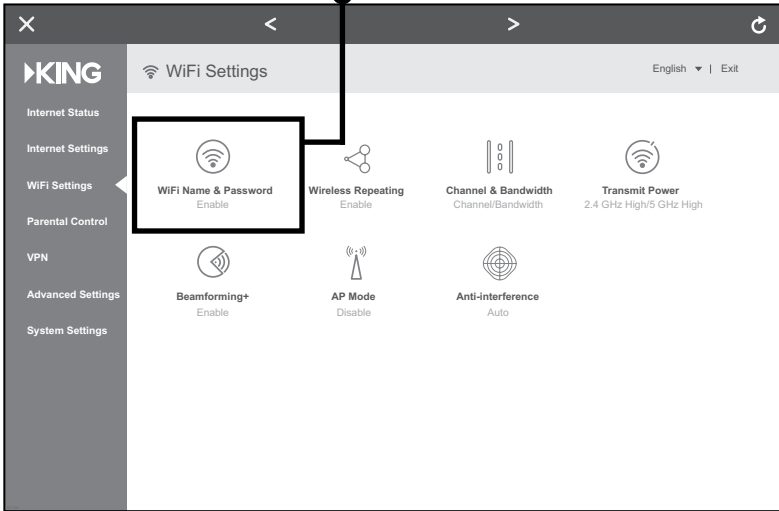

4. This screen should appear. Enter a custom Wi-Fi Name & Password for both your 2.4GHz and 5GHz networks. Tap “Save.”

TIP: When entering your new names, make sure to **completely erase** the existing names in the boxes.

TIP: KING highly recommends password protecting your name. Choose WPA/WPA2-PSK under “Encryption Mode” to enable password protection. (Passwords can be the same for both networks if you wish.)

TIP: Add “_5G” after your 5GHz network name to differentiate it from your 2.4GHz network name.

2.4GHZ

Write your network name here:

Write your password here:

5GHZ

Write your network name here:

Write your password here:

Congratulations! You have customized your router setup.

Close the web page and go to STANDARD OPERATION on next page.

STANDARD OPERATION

1. Go to your phone, tablet or computer's settings page and connect to the Wi-Fi Network with your customized network name.

The example shown is "MyWiFiName_5G".

If your device cannot connect to your 5G network, connect to your other network.



2. Open your device's web browser.

Go to: **<http://mykingwifi.com>**

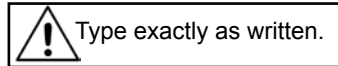

This screen should appear. Tap "WiFi Settings" in the left-hand column.

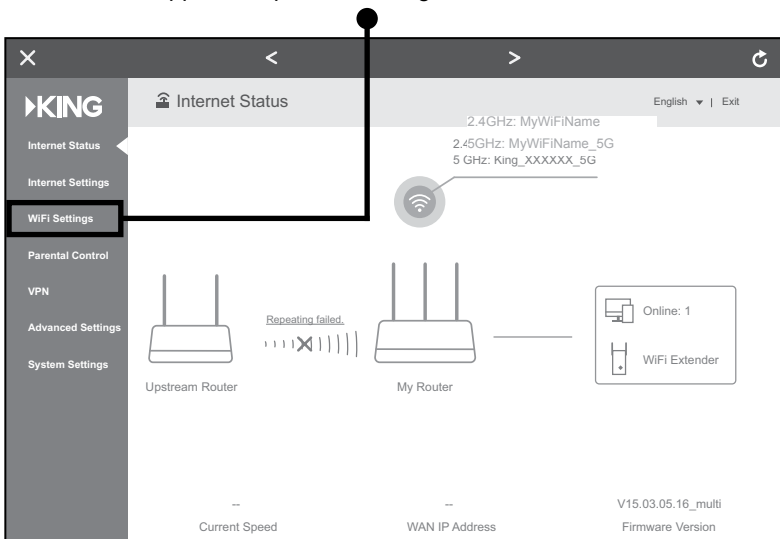

3. This screen should appear. Tap “Wireless Repeating.”

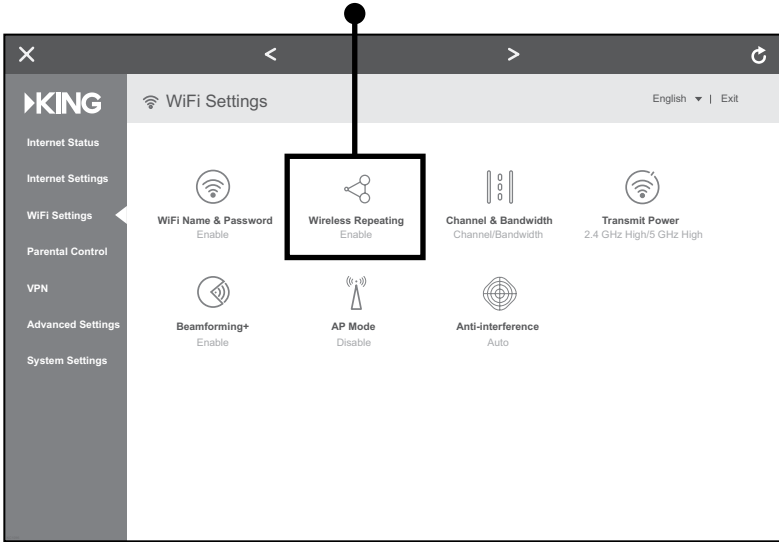

4. This screen should appear. Tap the blue arrows to scan for networks.

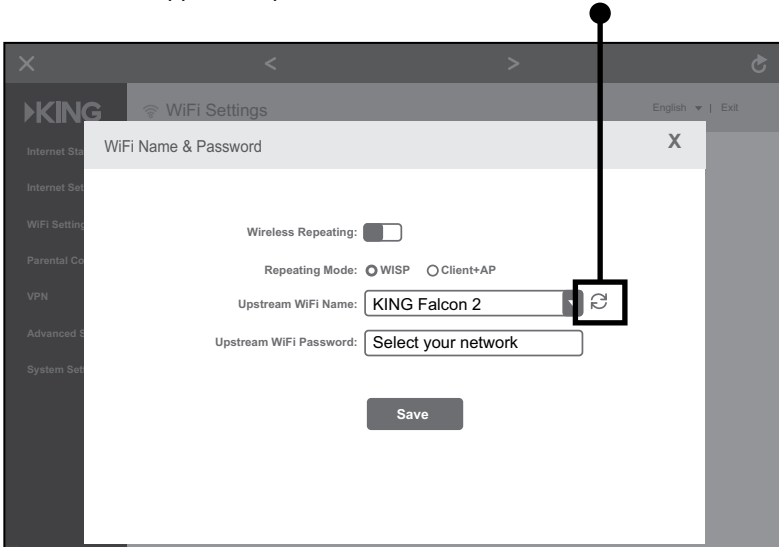

This screen should appear.

The router is scanning for networks.

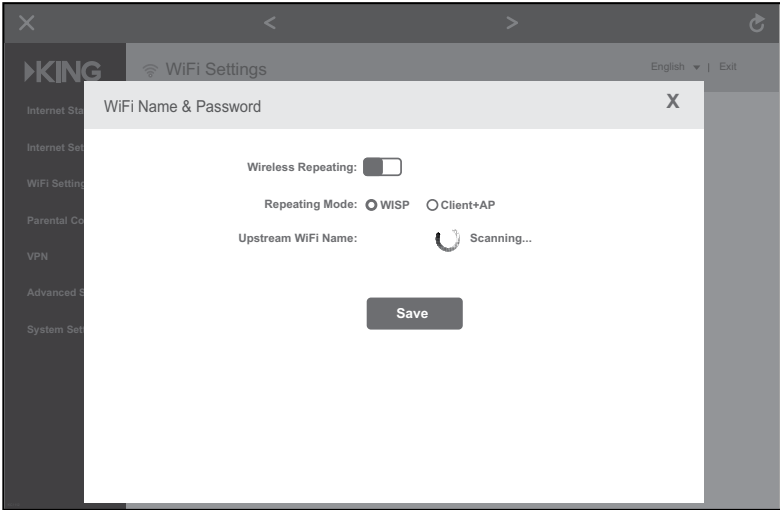

5. After the scanning process is complete, this screen should appear.

Tap on the "Upstream WiFi Name" drop down menu to display a list of available networks.

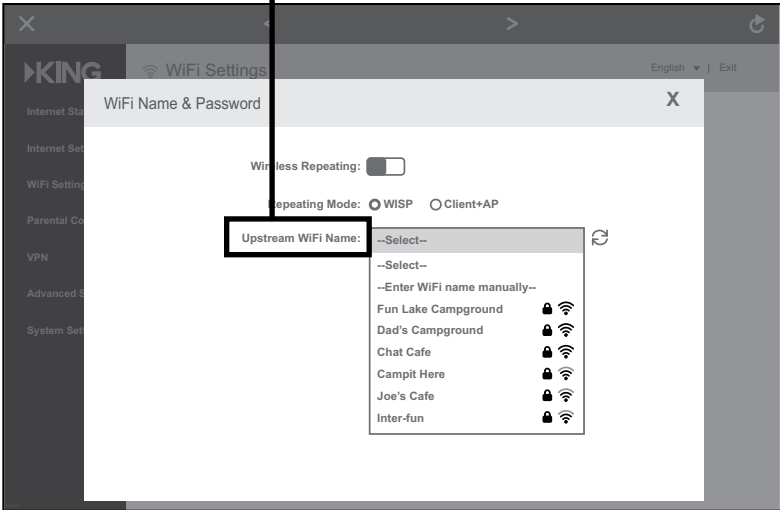

6. Select the network you would like to extend (not your customized router name) and input the password if necessary (not pictured).

Tap “Save.”

7. This popup should appear. Tap “OK.”

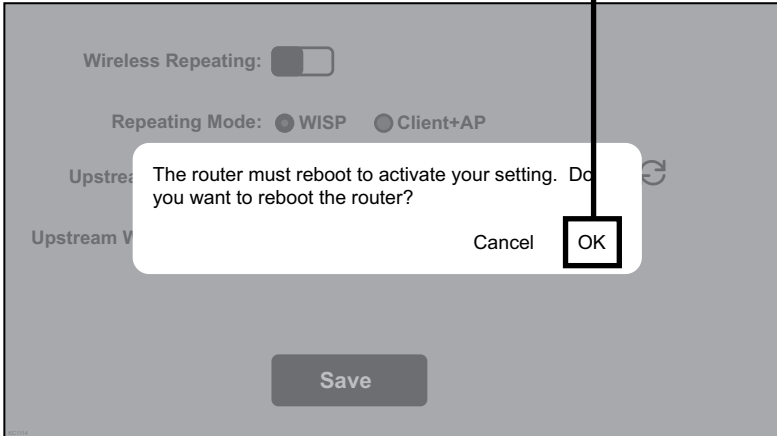

8. Your KING WiFiMax will reboot.



If your router gets stuck at 100% and won't finish rebooting,

or if your device does not have internet access, you may need to go back to your tablet or phone's settings page and ensure that you are connected to the Wi-Fi network with your customized network name, as you may lose connection during the router's rebooting process.

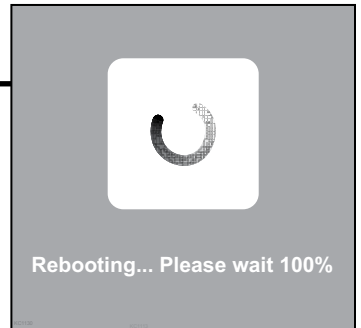

Congratulations, your KING WiFiMax is now extending your network!

INSTALLATION

- For best performance, the antenna should be located as far away as possible from other rooftop objects (TV antennas, AC units, etc.) and with the best all around line of sight.
 - When determining locations, make sure the long cable will reach the KING Wi-FiMax when attached to the KING Swift cable. (KING Swift cable may go directly to prewire enclosure - see opposite page).
 - Do not locate the KING Wi-FiMax or KING Swift in a slide-out.
 - Cable connection between KING Swift and long cable must always be inside vehicle (or prewire enclosure if using).
1. Drill 5/16" hole in roof where cable will enter roof. Feed long cable into position with enough cable sticking out of roof to attach KING Swift cable. **This end is marked "ROOF" and is red.**
 2. Connect KING Swift cable and long cable.
 3. Apply roof-compatible sealant around perimeter of bracket. Feed cable into hole, lower bracket into position and fasten to roof. **Seal fastener heads and cable hole in roof.**
 4. Inside vehicle, install wall plate if desired, and connect cable to KING Wi-FiMax.

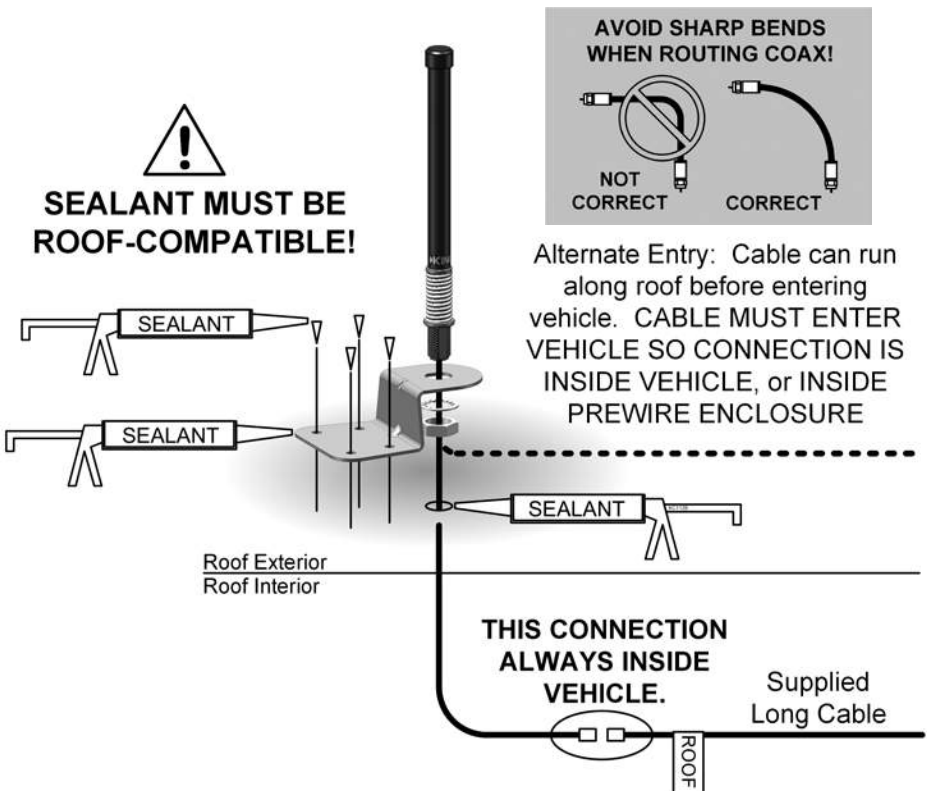

Prewire connections with OEM installed prewire enclosure

1. Remove (4) screws and take off the prewire cap.
2. Knock out the hole for the watertight connector.
3. Take the nut off the watertight connector.
4. Feed the cable through the connector, prewire cap, and nut.
5. Install the connector in the prewire cap with the nut.
6. Feed desired amount of cable through connector and tighten the connector's sealing nut.
7. Connect the two cables.
8. Replace the prewire cap and fasten with (4) screws.

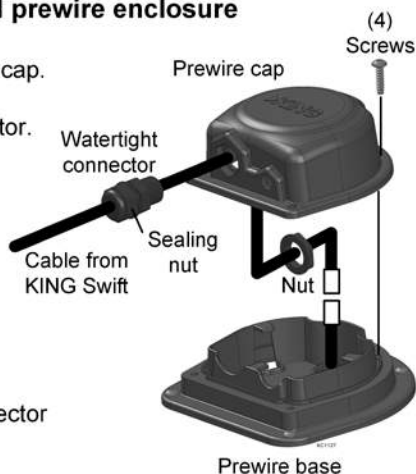

**DO NOT OVER-TIGHTEN
SCREWS INTO PLASTIC.**

⚠
Cable connection must be
made inside enclosure,
NOT ON ROOF!

IMPORTANT!

The installer is responsible for determining and supplying the most appropriate fasteners to secure the bracket to the roof.

All holes, fastener heads, and the entire perimeter of the bracket must be completely sealed and weatherproofed with roof-compatible sealant.



OR

Cable Entry
Cover

OR

Prewire Enclosure
(OEM installed)



See the satellite accessories page
at kingconnect.com

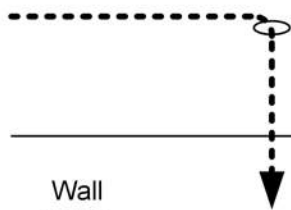

Wall
Plate

Connects to
KING WiFiMax

If there was a prewire enclosure on the roof, you will find a preinstalled wall plate in the vehicle. Remove this wall plate and install the included black or white wall plate.

TROUBLESHOOTING

The KING WiFiMax doesn't power on (no blue lights on front).

Make sure power supply plug is securely inserted into back of KING WiFiMax. Make sure the power supply is plugged into a known good power outlet.

I can't find the network KING_XXXXXX_5G or KING_XXXXXX.

Make sure your KING WiFiMax is plugged in. It may take up to a minute for these networks to appear. Some older devices may be unable to see the 5GHz network. This is completely okay; just use the KING_XXXXXX network.

I can't connect to mykingwifi.com

Make sure you are connected to your KING WiFiMax's network. Then make sure you type in the web address exactly as it appears in this manual: <http://mykingwifi.com>.

I can't enter a password in the designated box.

Choose WPA/WPA2-PSK under "Encryption Mode" (right above the password box) to enable password protection.

I don't see the Upstream WiFi name I want to extend in my list of networks.

If a network is very far away or very weak, the KING WiFiMax may not be able to see it, or may not offer it as an option. Try scanning again for networks by clicking on the blue circular arrows. If your network is still not offered as an option, try moving your KING WiFiMax to a location closer to your desired network.

When my router reboots, it gets stuck at 100% and won't finish rebooting.

Try reloading the page. If the page won't load, make sure your device is still connected to the KING WiFiMax. It may have disconnected during the reboot.

The KING WiFiMax doesn't seem to extend the range of my Wi-Fi, or has trouble picking up signal from my source.

Make sure all 4 antennas (3 if KING Swift is connected) are pointing up. If wall mounting, antennas must be rotated to point up (or down) as well.

Certain types of obstructions (other vehicles, buildings, or large amounts of metal) can reduce signal levels. Try relocating the KING WiFiMax.

Let us help!

KING Customer Service

952-345-8147

SPECIFICATIONS

KING WiFiMax

Power:	Included 12v power supply, requiring 110V AC plug-in
Wireless standards:	IEEE802.11a/b/g/n/ac
Supported Frequencies:	2.4GHz and 5GHz (dual-band)
Security:	WPA/WPA2-PSK
Storage Environment:	Temperature -40°F to 158°F

KING Swift

Radio Frequency Band:	2.4GHz
Wireless Standards:	IEEE802.11a/b/g/n
Antenna:	3dBi roof-mounted omnidirectional antenna
Height:	9.5"
Diameter:	0.75"
Weight:	0.25LBS

LIMITED WARRANTY

Each new KING WiFiMax and King Swift is thoroughly inspected and tested before leaving the factory, and is covered by the following limited warranty from the date of original purchase:

- One-year parts warranty: The customer is not responsible for the cost of replacement parts if the original part is determined to be defective under the terms of the warranty. The customer is responsible for the cost of replacement parts after one year.

Only KING and certified dealers may perform warranty evaluations and repairs. Depending upon the problem, KING may authorize a dealer to perform the necessary repairs. Any warranty labor outside of that performed at the factory is not covered unless 1) the product has been installed by an authorized dealer/installer or OEM manufacturer and 2) the dealer/installer receives prior authorization to perform the repair.

A certified dealer must not perform any repair without first contacting KING for a Service Order Number. KING will advise the dealer on how to proceed with any repairs.

Should any trouble develop during the warranty period, contact KING at (952) 922-6889. You must contact KING before the warranty period expires. The customer must supply proof of purchase (such as a dated sales receipt) when requesting warranty service. If the customer cannot supply proof of purchase, warranty period shall start 30 days after date of manufacture.

If it is determined that the unit needs to be returned to KING, customer must return COMPLETE product, freight prepaid, to: **KING, 11200 Hampshire Avenue South, Bloomington, MN 55438-2453.**

If inspection shows the trouble is caused by defective workmanship or material, KING will repair (or at its option, replace) without charge.

When returning product, KING will supply an RMA number (Return Merchandise Authorization). This number must be clearly written on the box. Failure to clearly write RMA number on box will result in delays in processing claim. Along with product, the customer should include in the box: his/her name, address, daytime phone number, proof of purchase and description of the problem.

This warranty does not cover installation and external wiring, or remanufactured units. This warranty does not cover damage caused by the use of an accessory other than a KING accessory designed for the product. This warranty is not transferable from the original owner.

Due to the expanding and changing TV market, KING cannot be held responsible for changes made to satellite services. Software updates to address such issues are not covered under warranty.

This warranty also does not apply where:

- The product has been abused, misused, improperly installed or improperly maintained.
- The product has been used with an accessory other than a KING accessory designed for the product.
- Repairs have been made or attempted by others that are not certified by KING to do such repairs.
- Repairs are required because of normal wear and tear.
- Alterations have been made to the product.
- The product or any associated component has been opened without authorization or disassembled to any degree.
- Damage has been caused by power washing.
- Circumstances beyond the control of KING cause the product to no longer operate correctly.
- Customer is not the original owner.

In no event shall KING be liable for any indirect, incidental, or consequential damages from the sale or use of the product. This disclaimer applies both during and after the term of this warranty.

KING disclaims liability for any implied warranties, including implied warranties of "merchantability" and "fitness for a specific purpose," after the term of this warranty.

This warranty gives you specific legal rights, and you may also have other rights, which vary from state to state. Some states do not allow the exclusion or limitation of incidental or consequential damages, so the above limitation or exclusion may not apply to you. Some states do not allow limitations on how long an implied warranty lasts, so the above limitation may not apply to you.

WIRELESS REGULATORY INFORMATION

FCC Statement

This device complies with part 15 of the FCC Rules. Operation is subject to the following two conditions: (1) This device may not cause harmful interference, and (2) this device must accept any interference received, including interference that may cause undesired operation.

Note: This equipment has been tested and found to comply with the limits for a Class B digital device, pursuant to part 15 of the FCC Rules. These limits are designed to provide reasonable protection against harmful interference in a residential installation. This equipment generates, uses and can radiate radio frequency energy and, if not installed and used in accordance with the instructions, may cause harmful interference to radio communications. However, there is no guarantee that interference will not occur in a particular installation. If this equipment does cause harmful interference to radio or television reception, which can be determined by turning the equipment off and on, the user is encouraged to try to correct the interference by one or more of the following measures:

- Reorient or relocate the receiving antenna.
- Increase the separation between the equipment and receiver.
- Connect the equipment into an outlet on a circuit different from that to which the receiver is connected.
- Consult the dealer or an experienced radio/TV technician for help.

FCC Caution

Any changes or modifications not expressly approved by the party responsible for compliance could void the user's authority to operate this equipment.

This transmitter must not be co-located or operating in conjunction with any other antenna or transmitter.

IEEE 802.11b or 802.11g operation of this product in the USA is firmware-limited to channels 1 through 11.

The device for the band 5150-5250 MHz is only for indoor usage to reduce the potential for harmful interference to co-channel mobile satellite systems.

Radiation Exposure Statement

This device complies with FCC radiation exposure limits set forth for an uncontrolled environment and it also complies with Part 15 of the FCC RF Rules. This equipment should be installed and operated with minimum distance 20 cm between the radiator and your body.

Innovation, Science and Economic Development Canada Statement

CAN ICES-3 (B)/NMB-3(B)

This device contains licence-exempt transmitter(s)/receiver(s) that comply with Innovation, Science and Economic Development Canada's licence-exempt RSS(s). Operation is subject to the following two conditions: (1) This device may not cause interference, and (2) This device must accept any interference, including interference that may cause undesired operation of the device.

For product available in the USA/Canada market, only channel 1-11 can be operated. Selection of other channels is not possible.

The device could automatically discontinue transmission in case of absence of information to transmit, or operational failure. Note that this is not intended to prohibit transmission of control or signaling information or the use of repetitive codes where required by the technology.

Innovation, Science and Economic Development Canada Radiation Exposure Statement

This equipment complies with ISED radiation exposure limits set forth for an uncontrolled environment. This equipment should be installed and operated with minimum distance 20 cm between the radiator and your body.

This device and its antenna(s) must not be co-located or operating in conjunction with any other antenna or transmitter except in accordance with ISED multi-transmitter product procedures.

Restrictions in the 5 GHz Band

The device for the band 5150-5250 MHz is only for indoor usage to reduce the potential for harmful interference to co-channel mobile satellite systems.

The maximum antenna gain permitted for devices in the band 5725-5825 MHz shall comply with the e.i.r.p. limits specified for point-to-point and non point-to-point operation as appropriate.

Users should also be advised that high-power radars are allocated as primary users (i.e. priority users) of the bands 5250-5350 MHz and 5650-5850 MHz and that these radars could cause interference and/or damage to LE-LAN devices.

This radio transmitter (6873A-KWM1000) has been approved by Innovation, Science and Economic Development Canada to operate with the antenna types listed below with the maximum permissible gain indicated. Antenna types not included in this list that have a gain greater than the maximum gain indicated for any type listed are strictly prohibited for use with this device.

Detachable antenna:

- 5 dBi at 2.4 GHz, 50Ω, Dipole

Additional requirements for the band 5600-5650 MHz

Until further notice, devices subject to this Section shall not be capable of transmitting in the band 5600-5650 MHz, so that Environment Canada weather radars operating in this band are protected.

AVIS d'Innovation, Sciences et Développement économique Canada

CAN ICES-3 (B)/NMB-3(B)

L'émetteur/récepteur exempt de licence contenu dans le présent appareil est conforme aux CNR d'Innovation, Sciences et Développement économique Canada applicables aux appareils radio exempts de licence. L'exploitation est autorisée aux deux conditions suivantes : (1) L'appareil ne doit pas produire de brouillage, et (2) L'appareil doit accepter tout brouillage radioélectrique subi, même si le brouillage est susceptible d'en compromettre le fonctionnement.

Pour les produits disponibles sur le marché aux États-Unis et au Canada, seuls les canaux de 1 à 11 peuvent être utilisés. La sélection d'autres canaux n'est pas possible.

Le dispositif peut automatiquement cesser d'émettre en cas d'absence d'informations à transmettre, ou à cause d'une défaillance technique. Notez que l'objet n'est pas d'interdire la transmission des informations de contrôle ou de signalisation ou l'utilisation de codes répétitifs lorsque requis par la technologie.

Avis d'Innovation, Sciences et Développement économique Canada concernant l'exposition aux radiofréquences

Ce matériel est conforme aux limites établies par ISED en matière d'exposition aux radiofréquences dans un environnement non contrôlé. Ce matériel doit être installé et utilisé à une distance d'au moins 20 cm entre l'antenne et le corps de l'utilisateur.

Cet appareil et son (ses) antenne(s) ne doivent pas être situés à proximité ou fonctionner en association avec une autre antenne ou un autre émetteur autre qu'en respectant les procédures d'ISED relatives au fonctionnement des dispositifs multi-émetteurs.

Restrictions dans la bande 5 GHz

L'appareil pour la bande de 5150 à 5250 MHz est conçu pour usage à l'intérieur seulement afin de réduire le potentiel d'interférences pour les systèmes mobiles par satellite qui utilisent le même canal.

Le gain maximal d'antenne permis (pour les dispositifs utilisant la bande 5725-5825 MHz) doit se conformer à la limite de p.i.r.e. spécifiée pour l'exploitation point à point et non point à point, selon le cas.

De plus, les utilisateurs devraient aussi être avisés que les utilisateurs de radars de haute puissance sont désignés utilisateurs principaux (c.-à-d., qu'ils ont la priorité) pour les bandes 5250-5350 MHz et 5650-5850 MHz et que ces radars pourraient causer du brouillage et/ou des dommages aux dispositifs LAN-EL.

Le présent émetteur radio (6873A-KWM1000) a été approuvé par Innovation, Sciences et Développement économique Canada pour fonctionner avec les types d'antenne énumérés ci-dessous et ayant un gain admissible maximal. Les types d'antenne non inclus dans cette liste, et dont le gain est supérieur au gain maximal indiqué pour tout type figurant sur la liste, sont strictement interdits pour l'exploitation de l'émetteur.

Antenne détachable:

- 5 dBi à 2.4 GHz, 50Ω, Dipôle

Prescriptions supplémentaires pour la bande 5600-5650 MHz

Jusqu'à nouvel ordre, les appareils faisant l'objet de la présente section ne doivent pas transmettre dans la bande 5600-5650 MHz, afin que les radars météorologiques d'Environnement Canada fonctionnant dans cette bande soient protégés.

Simply better, by design.™



11200 Hampshire Avenue South, Bloomington, MN 55438
PH 952.922.6889 || FAX 952.922.8424 || kingconnect.com

©2018 KING 23180 Rev A

All trademarks are the sole property of their respective owners.

KING || FALCON™

Automatic Directional Wi-Fi Antenna

Installation and Operating Instructions



KF1000 • White
KF1001 • Black

KING || WiFiMax™

includes the KING
WiFiMax Router
KWM1000



CONTENTS

OPERATION	1-20
INSTALLATION	22-29
TROUBLESHOOTING	30
SPECIFICATIONS	31
LIMITED WARRANTY	32
WIRELESS REGULATORY INFORMATION	33

NOTE: Please read thru this manual before using or installing.
You will need to download the free KING Wi-Fi app to
use this product (see page 1).

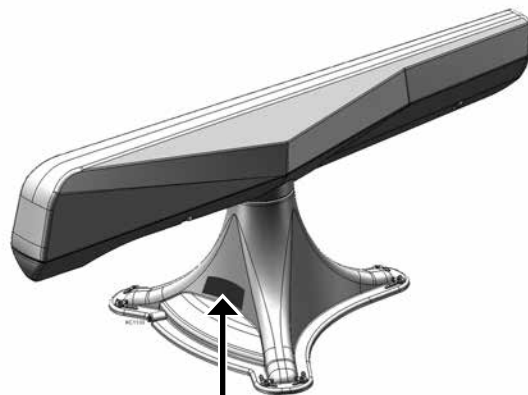

Record your serial number.

Thank you for choosing a KING Falcon antenna!

The KING Falcon is an outdoor, automatic directional 2.4GHz Wi-Fi antenna. Using the KING Wi-Fi app, the KING Falcon automatically rotates and scans 360 degrees and shows you all of the available networks. Simply tap the network you want and the KING Falcon automatically aims itself to get the best performance from that network.

The KING WiFiMax Wi-Fi Router/Range Extender creates your own private and secure Wi-Fi network, just like you have in your home. When you are in range of an available network, simply configure your KING WiFiMax to connect to that network, and it then extends the internet access from that network to your own private Wi-Fi network.

BEFORE USING YOUR KING FALCON ANTENNA



Before using the KING Falcon, you must download the free KING Wi-Fi app from the Apple® App Store® or Google Play™ Store. When in the store, search for “KING Wi-Fi.”

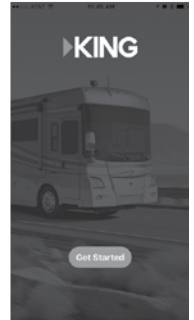

Make sure the power inserter and the KING WiFiMax router are connected and plugged in as shown.

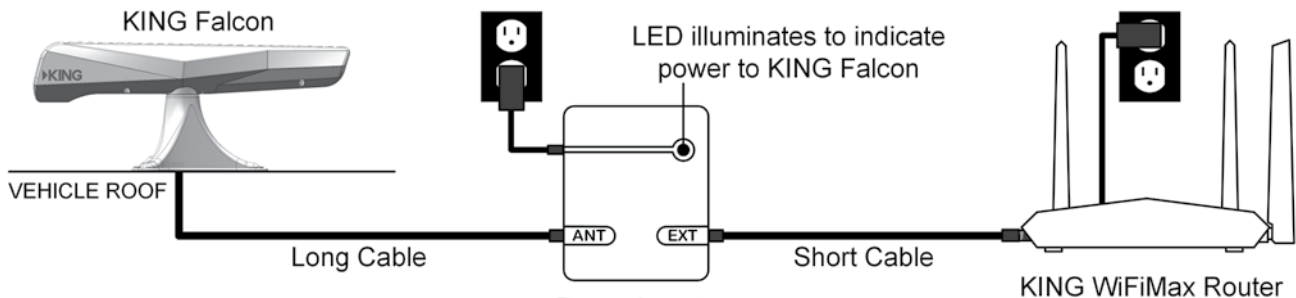

Do not power wash any part of the KING Falcon antenna head or base mount.

FIRST-TIME USE: Go to the next page and follow the first-time use instructions.

IF YOU HAVE COMPLETED FIRST-TIME USE: Go to STANDARD OPERATION on page 16.

OPERATING NOTES

Do not operate the KING Falcon while the vehicle is in motion.

The KING Falcon will not locate Wi-Fi signals while the vehicle is in motion.

You must leave the power inserter and KING WiFiMax connected and plugged in while using your Wi-Fi.

Any time you move your vehicle, you will have to scan for a network again.

FIRST-TIME USE

1. SET UP KING WIFIMAX

NOTE: Make sure your KING WiFiMax and power injector are connected and powered on as shown on page one (blue lights on both devices will turn on when power is connected).



To maintain the best connection to your KING WiFiMax, it is suggested that the cellular network on your smart phone or tablet be turned off while completing the first-time setup.

1. Go to your smart phone or tablet's Wi-Fi settings page and connect to the KING 5G network:

KING_XXXXXX_5G



XXXXXX is a number/letter combination unique to your router and can be found on the bottom of your router in the SSID row.



Graphics will vary.

If you do not see **KING_XXXXXX_5G** (5GHz network), connect to **KING_XXXXXX** (2.4GHz network).

Always choose the 5G network if possible, as it is faster than the 2.4GHz network.

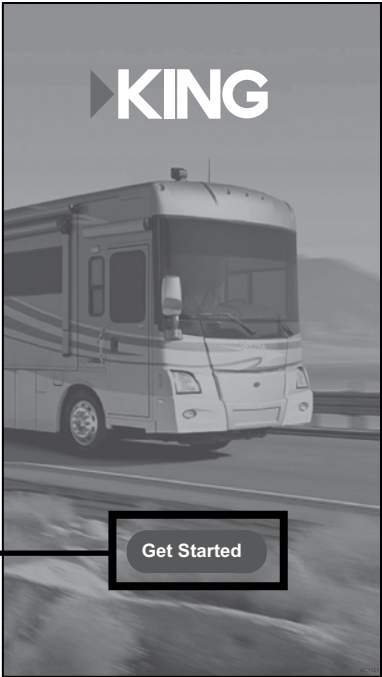

2. Open the KING Wi-Fi app and tap "Get Started."

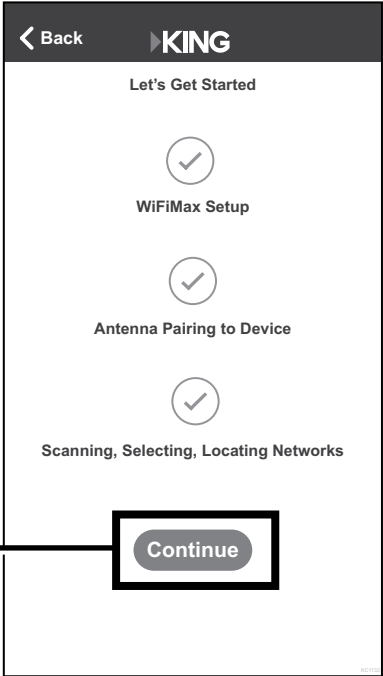

3. Tap "Continue" to begin your KING WiFiMax setup.

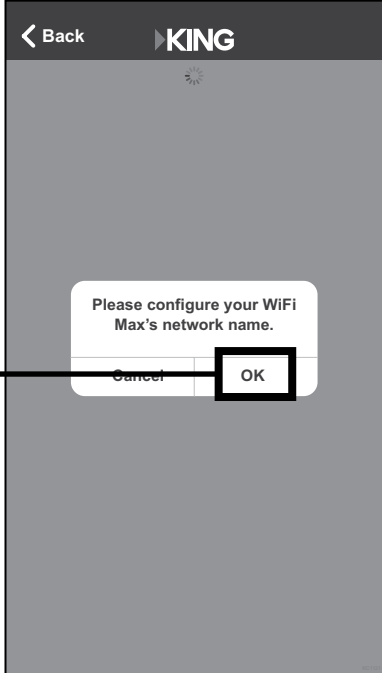

4. Tap "OK" on the pop up screen.

TIP Use your phone or tablet's zoom functionality to change the view of your screen.

5. This screen should appear. Tap “WiFi Settings” in the left-hand column.

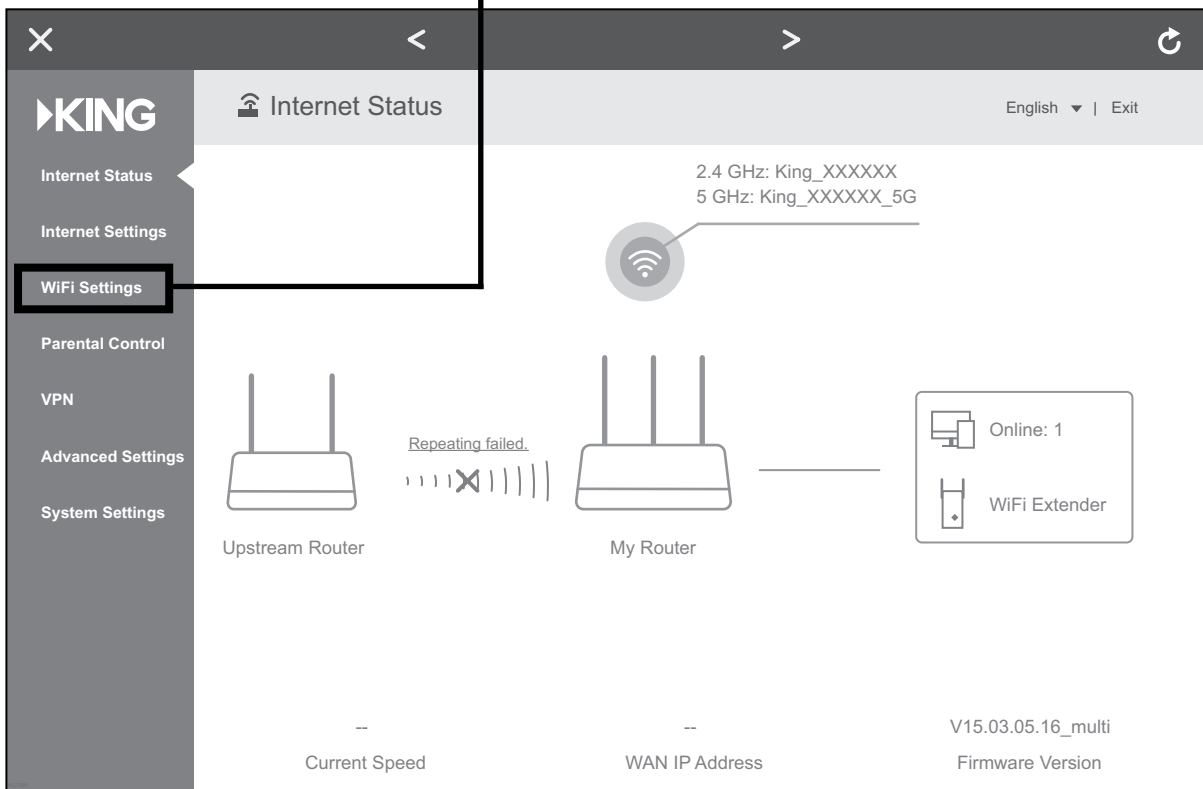

6. This screen should appear. Tap “WiFi Name & Password.”

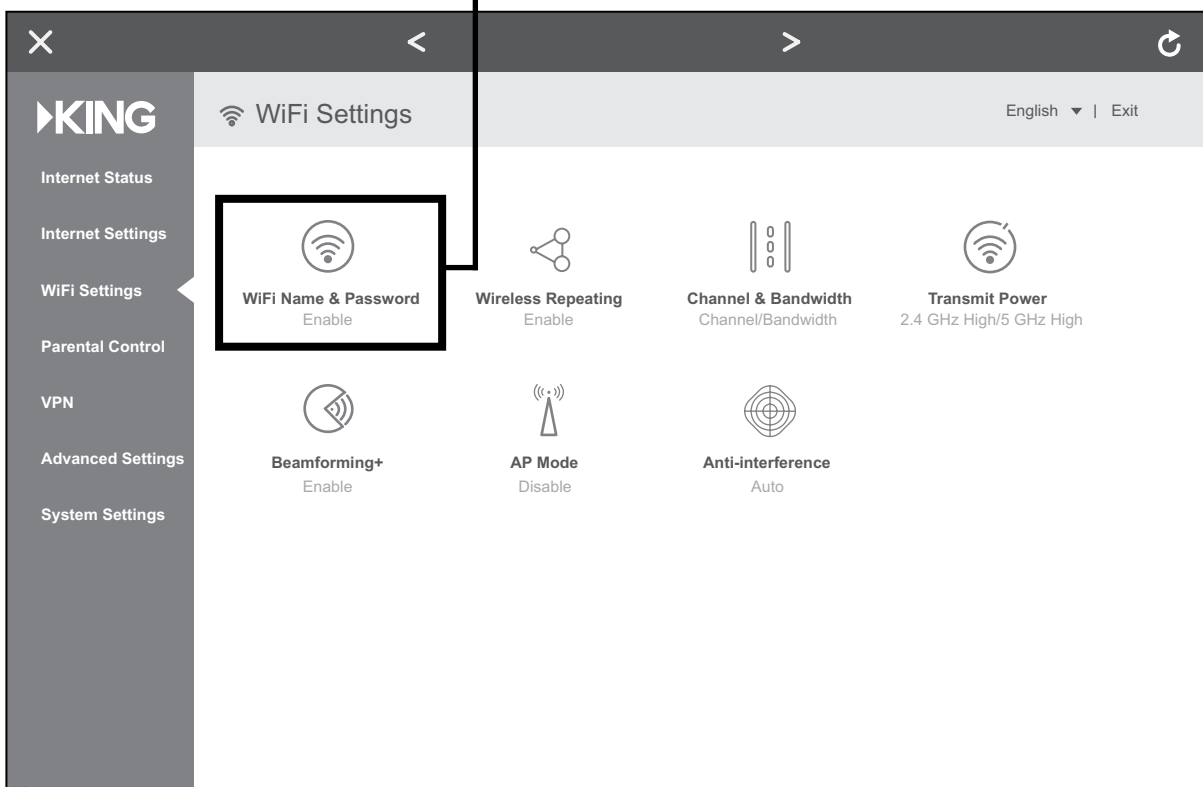

7. The screen below should appear. Here you **MUST** change your Wi-Fi name and password to personalize it and keep it secure. Do steps A and B for both the 2.4 GHz and 5GHZ networks (you will only have to do this once).

A Enter a new Wi-Fi name.



When entering your new names, make sure to **completely erase** the existing names in the boxes.



Add “_5G” after your 5GHz network name to differentiate it from your 2.4GHz network name.

B Enter a password.



KING highly recommends password protecting your name. Choose WPA/WPA2-PSK under “Encryption Mode” to enable password protection. Passwords can be the same for both networks if you wish, and must be at least 8 characters.

When you have entered names and passwords for **both** networks, tap “Save.”

Tap the “X” to exit the KING WiFiMax setup screen.

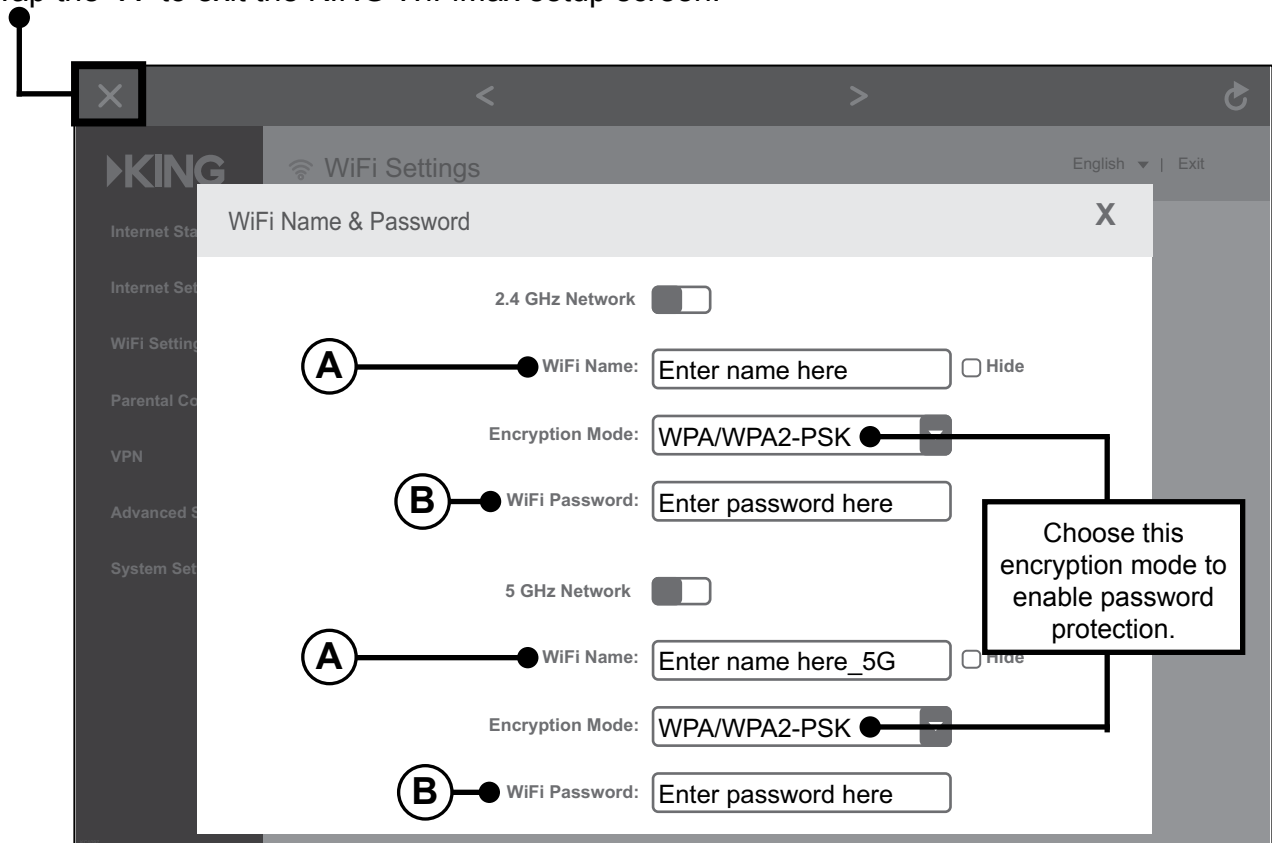

2.4G

Write your network name here:

Write your password here:

5G

Write your network name here:

Write your password here:

You have personalized your router setup.

Continue on next page.

2. CONNECT TO THE KING WIFIMAX WITH YOUR PERSONALIZED NETWORK NAME

1. Once you have configured your KING WiFiMax network names in the previous step, this pop up will appear.



Do not click on "OK." Instead, exit the app.



TIP For best performance, choose the 5GHz network whenever possible.

2. Go to your smart phone or tablet's Wi-Fi settings page and connect to the Wi-Fi Network with your personalized network name.

If your device cannot connect to your 5GHz network, connect to your other network.

Example: ●

"MyWiFiName_5G"

This will be the name you created in step 7, page 5.



3. Once you have connected, return to the app and tap "OK" in the pop up window.

When the next screen appears, tap the "X" in the upper left hand corner.

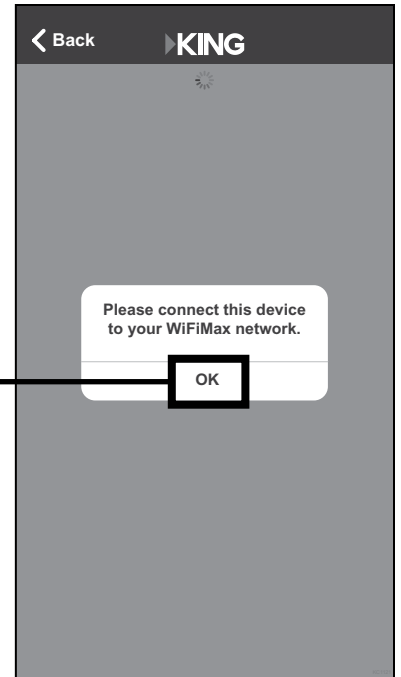

The KING WiFi app will confirm your KING WiFiMax setup and that the connection was successful. (Check mark turns green.)

4. To pair your antenna, tap "Continue" and go to the next page.

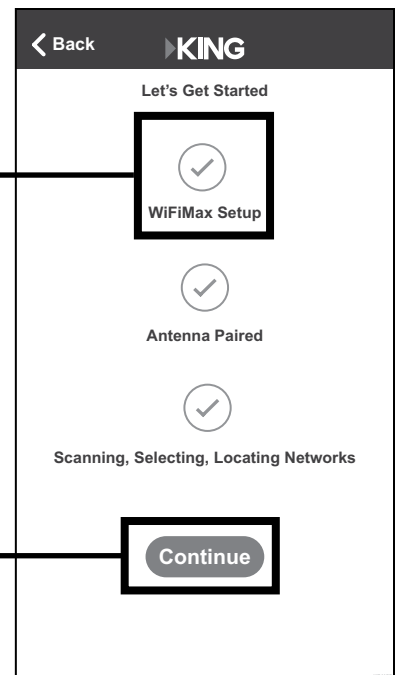

3. PAIR YOUR KING FALCON ANTENNA

1. A list of available KING Falcon antennas to connect to will appear. Identify your antenna and tap to select it.

TIP

If more than one antenna appears in the list: Match the last 5 digits of the antenna number to the serial number on the back of your KING Falcon to ensure you are selecting the correct antenna.

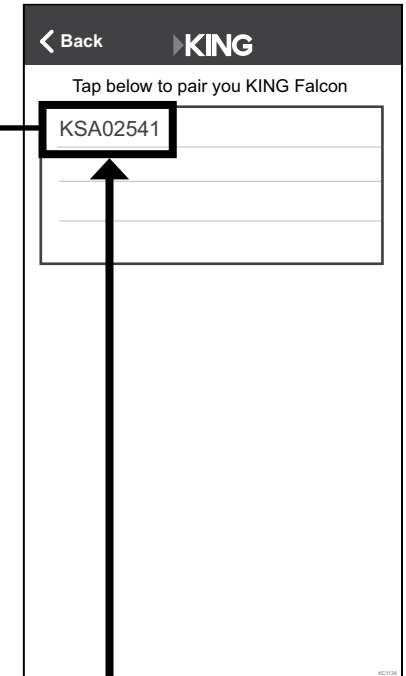
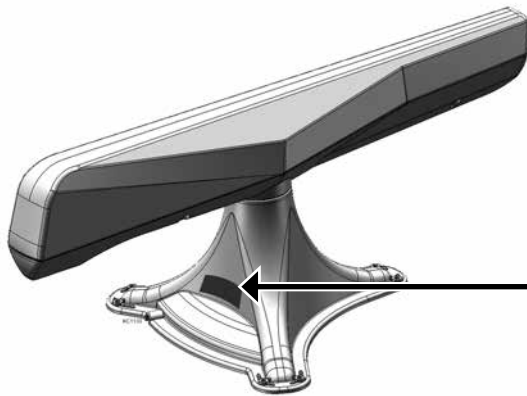

KSA02541

Example only:
your number will be different.

2. Enter the default PIN number, "0000" and tap "Continue" to pair your antenna.

You will be prompted to change your PIN - see next page.

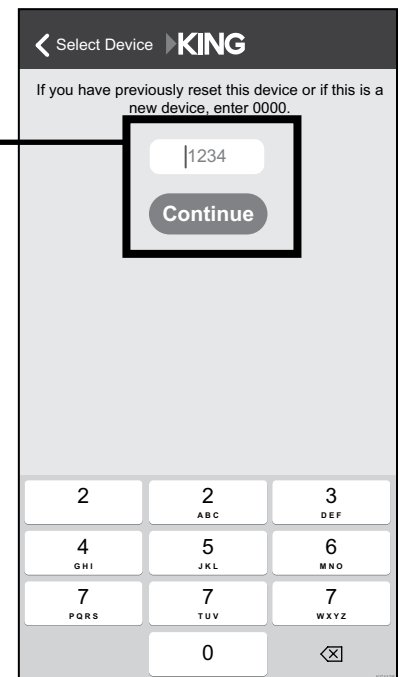

3. For increased security, you can change your PIN.

A second dialog box will allow you to do so. If you do not wish to, tap “Cancel.”

Write your PIN here:

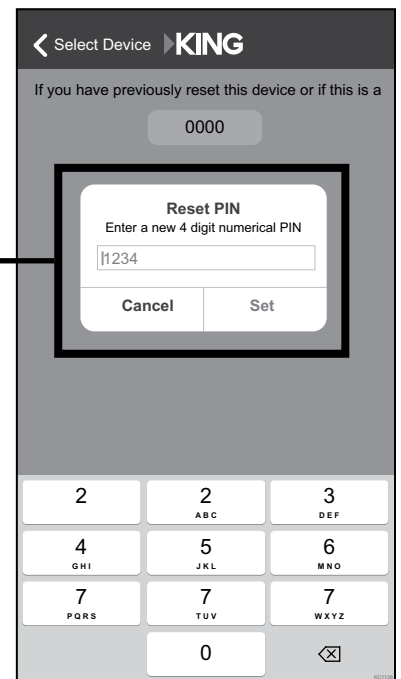

Only one smart phone or tablet can be paired with your KING Falcon antenna at a time. In the event you need to switch control of the KING Falcon antenna to a different device, and don't have the PIN, a PIN reset may be required.

TIP

Being paired with the antenna allows the user to aim and select upstream networks. You do NOT need to be paired to the KING Falcon to be connected to your personalized KING WiFiMAX network.

To UN-pair from a KING Falcon antenna, choose a different Wi-Fi network from your smart phone or tablet's settings or shut off your smart phone or tablet's Wi-Fi connectivity.

The app will confirm your KING Falcon antenna is properly paired with your smart phone or tablet. (Check mark turns green.)

4. To scan for and select available Wi-Fi networks, tap "Continue" and go to the next page.

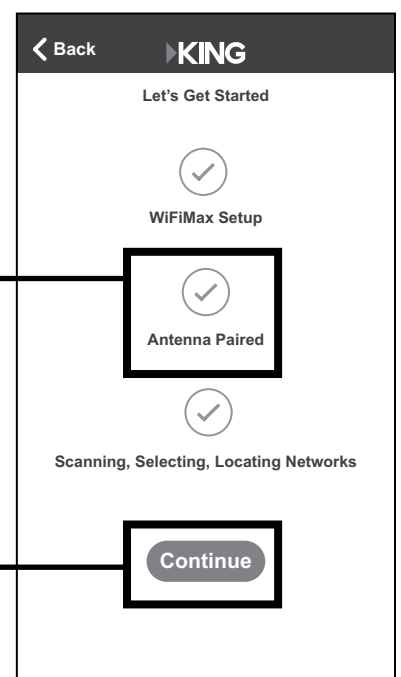

4. LOCATE & CONNECT TO AVAILABLE WI-FI NETWORKS

TIP

“Upstream” network refers to any network you would like to connect to. This could be a campground network, public Wi-Fi network, coffee shop, restaurant, hotel, etc.

Upstream networks may be password protected or accessible via captive portal. Contact the office, front desk, service counter, etc. to obtain the password or captive portal instructions at the location supplying the Wi-Fi.

1. The app will automatically begin to scan for available upstream networks. Once the scan is complete, select the upstream network that you would like to connect to.

Example: Fun Lake Campground



Do not select either of the 2.4GHz or 5GHz network names you created on page 5.

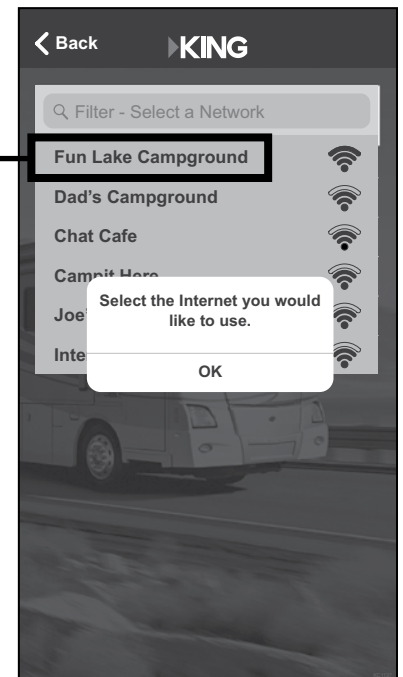
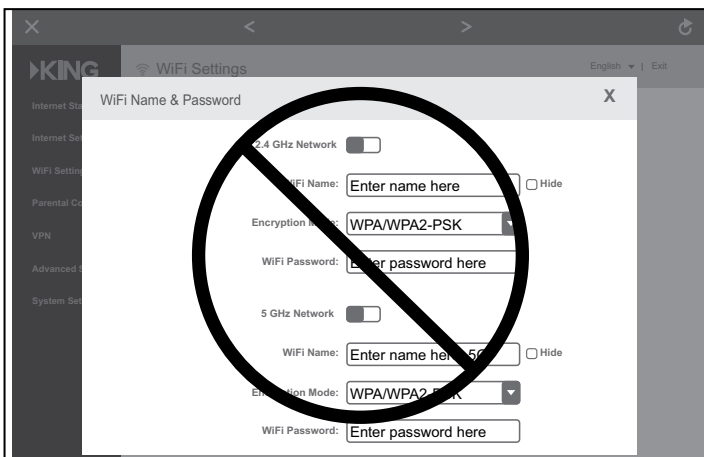

2. The KING Falcon will locate your selected network and confirm success.

3. Tap "Continue."

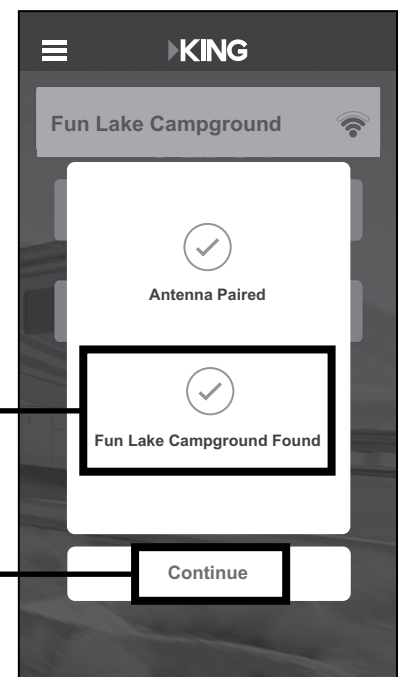

5. CONNECT TO YOUR KING WIFIMAX

1. Almost there! Tap "Continue."

2. Tap the menu icon to display menu options.

3. Tap on "KING WiFiMax Setup."

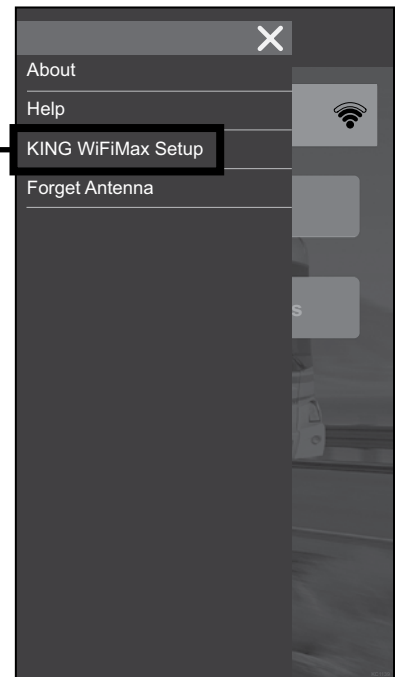
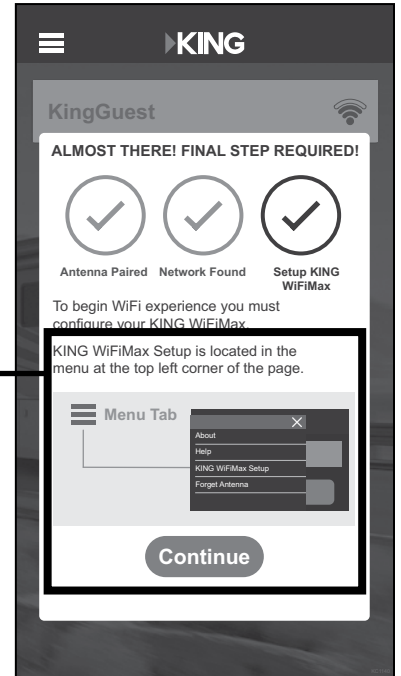
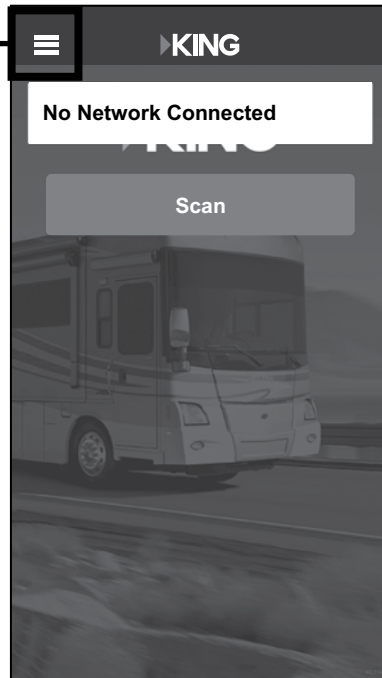

4. This screen should appear. Tap “WiFi Settings” in the left-hand column.

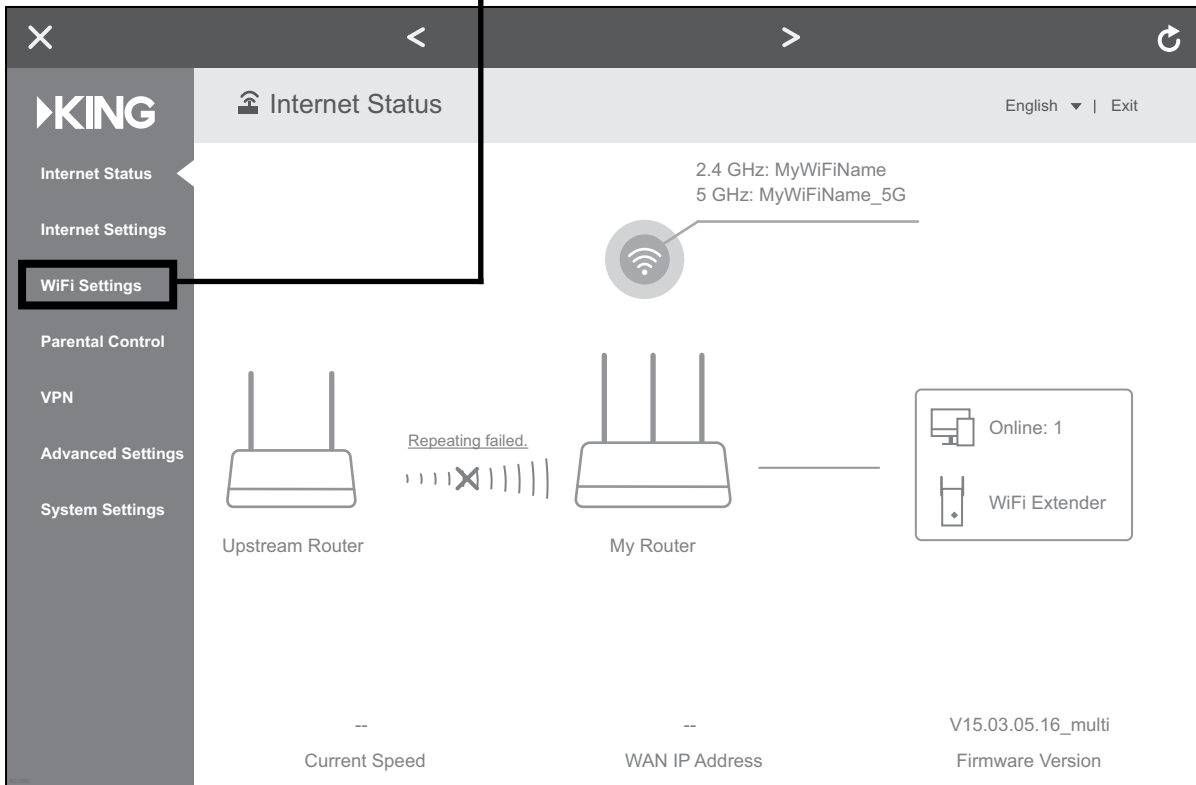

5. This screen should appear. Tap “Wireless Repeating.”

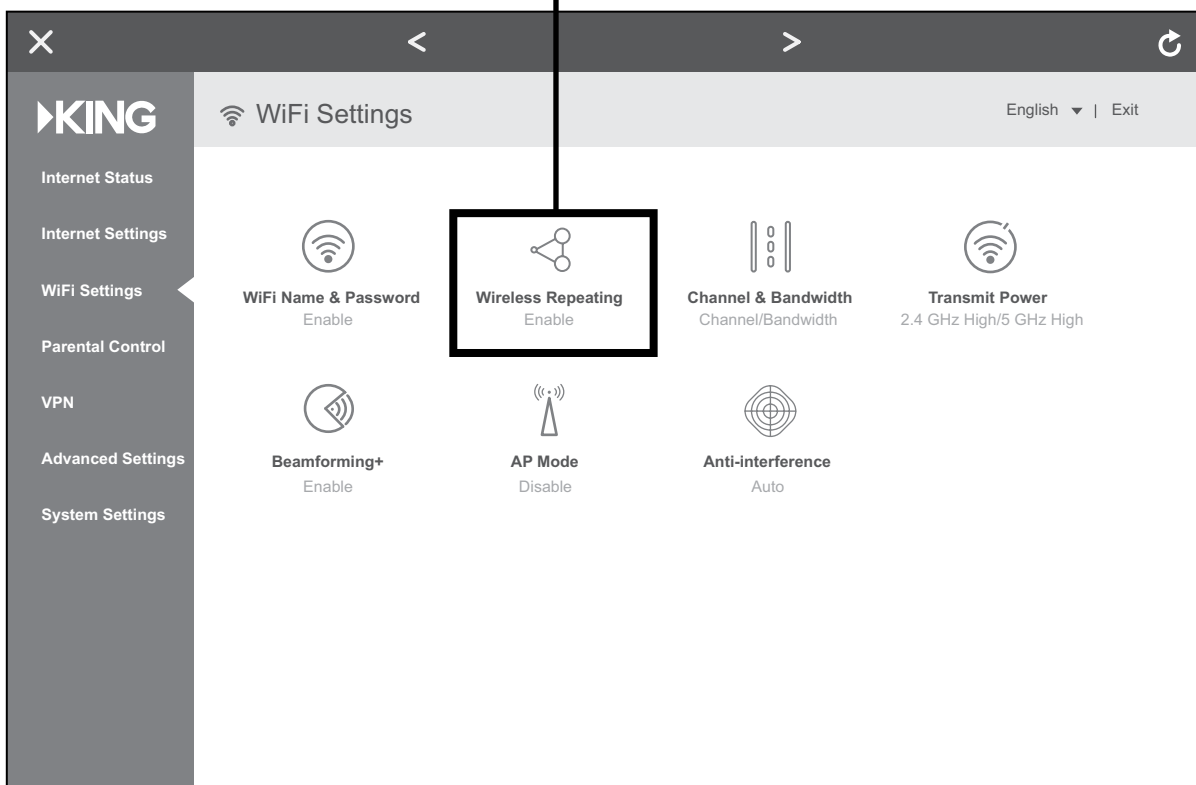

6. This screen should appear.
The router is scanning for networks.

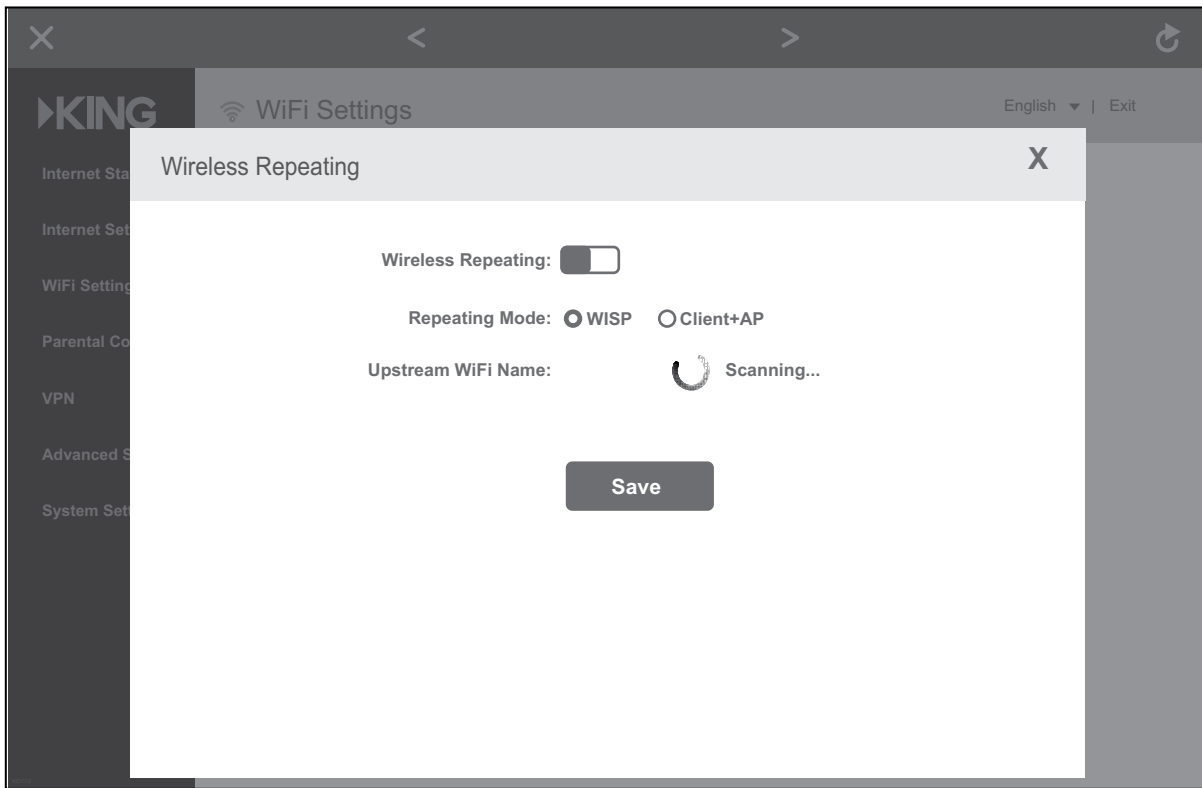

7. After the scanning process is complete, this screen should appear.
Tap the "Upstream WiFi Name" drop down menu to display a list of available networks.



8. Select the same upstream network as the one you pointed the KING Falcon at (page 10, step 1).

Example:

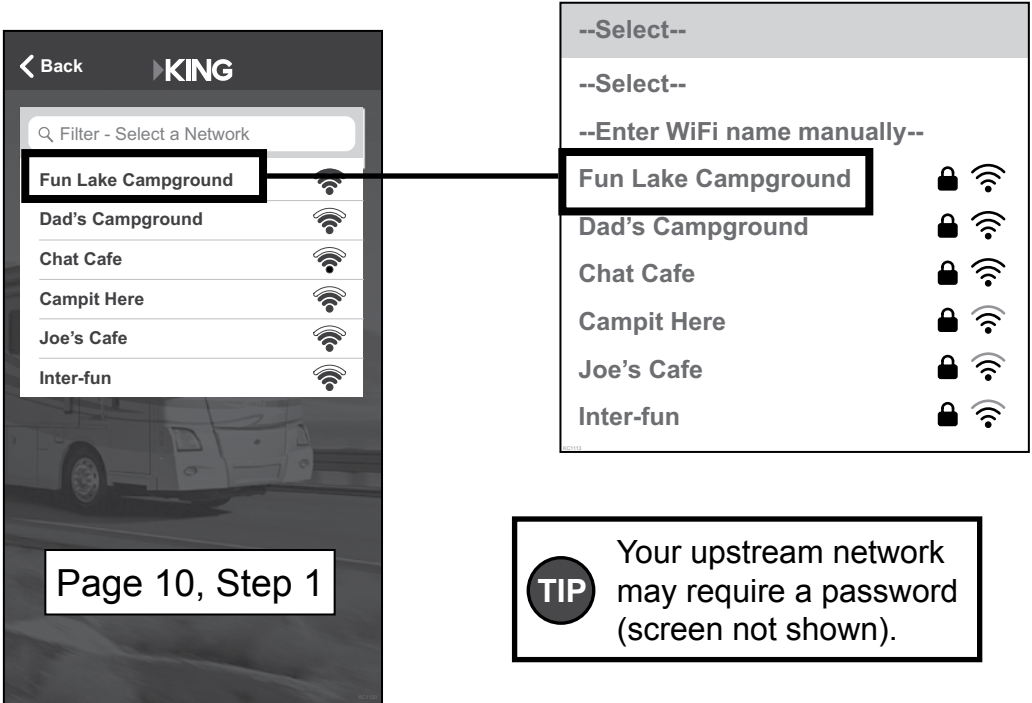

Page 10, Step 1

TIP Your upstream network may require a password (screen not shown).

9. Tap “Save.”

This popup should appear. Tap “OK.”

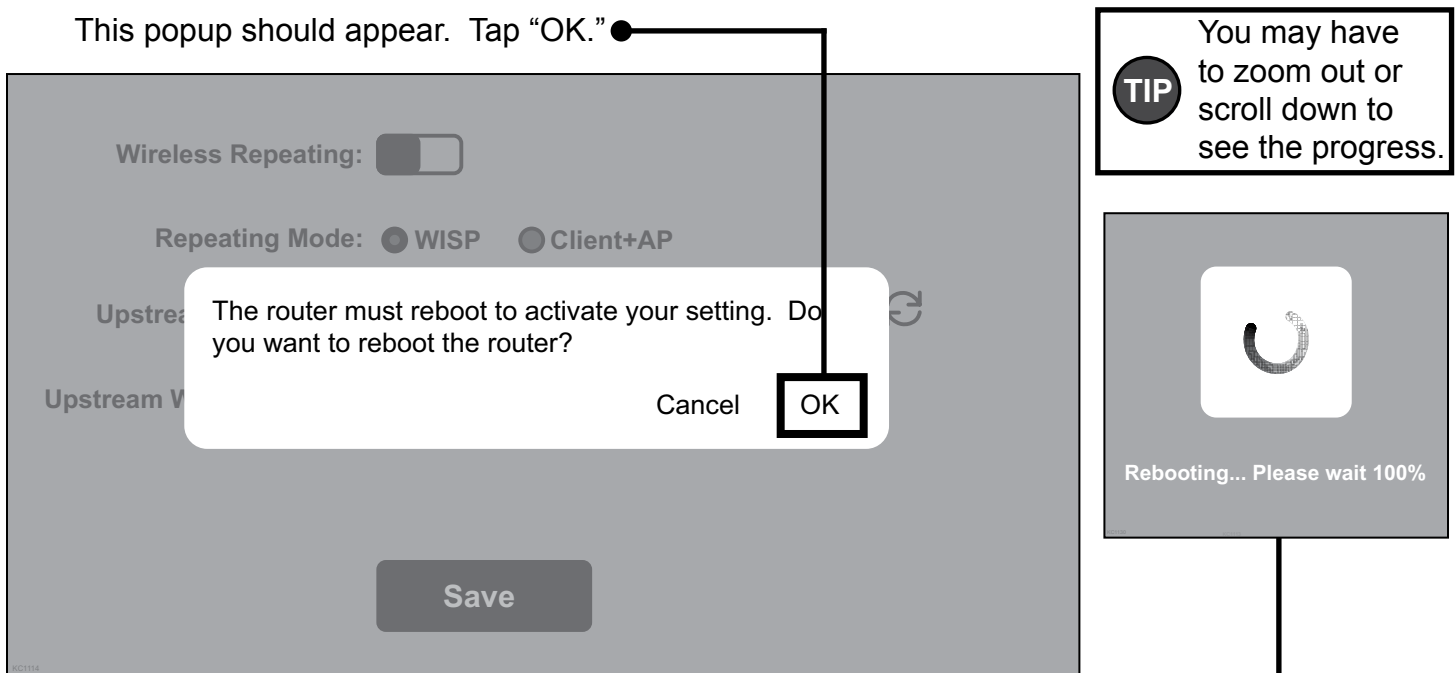

TIP You may have to zoom out or scroll down to see the progress.

Rebooting... Please wait 100%

10. Your KING WiFiMax will reboot.



If your router gets stuck at 100% and won't finish rebooting, or if your Wi-Fi device does not have internet access, you may need to go back to your smart phone or tablet's settings page and ensure that it reconnected to the Wi-Fi network with your personalized network name (page 5), as you may lose connection during the router's rebooting process.

Your KING WiFiMax is now extending your network!

TIP If you turned off your cellular network during this first-time setup, it is now safe to turn it back on.

This page intentionally left blank.

STANDARD OPERATION

TIP

To maintain the best connection to your KING WiFiMax, it is suggested that the cellular network on your smart phone or tablet be turned off while using standard operation.

1. Go to your smart phone or tablet's settings page and connect to the Wi-Fi Network with your personalized network name.

If your smart phone or tablet cannot connect to your 5GHz network, connect to your other network.

Example: ●

"MyWiFiName_5G"

This will be the name you created on page 5.



2. Open the KING Wi-Fi app and follow the instructions to either:

Start a rescan with the KING Falcon (for example you have moved and wish to scan for new networks) ●

OR

choose a list of previously scanned networks (for example your current choice of networks is currently unavailable and you wish to switch to an alternate one). ●

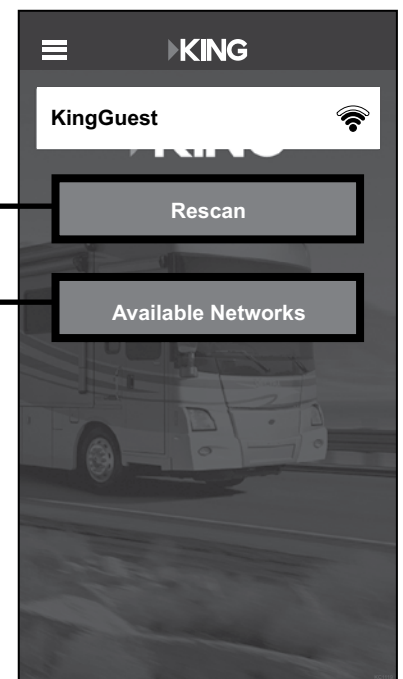

TIP

The "Available Network" button will not appear if:
Smart phone or tablet loses power.
KING Falcon antenna loses power.
Connection between KING Falcon and smart phone or tablet is lost.
App is closed.

3. Choose a network from the list generated by step 2.

Example: Fun Lake Campground

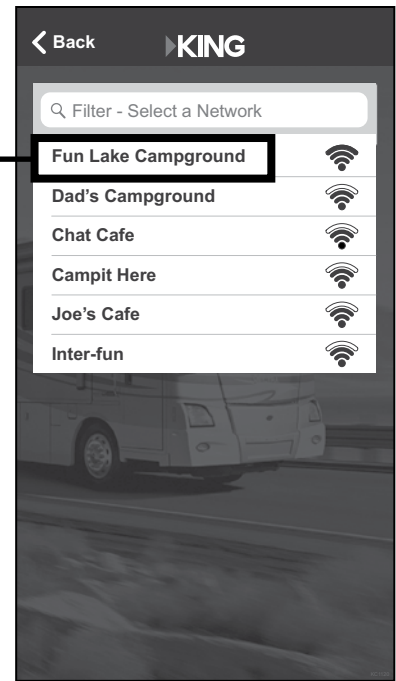

Do not select either of the 2.4GHz or 5GHz network names you created on page 5.

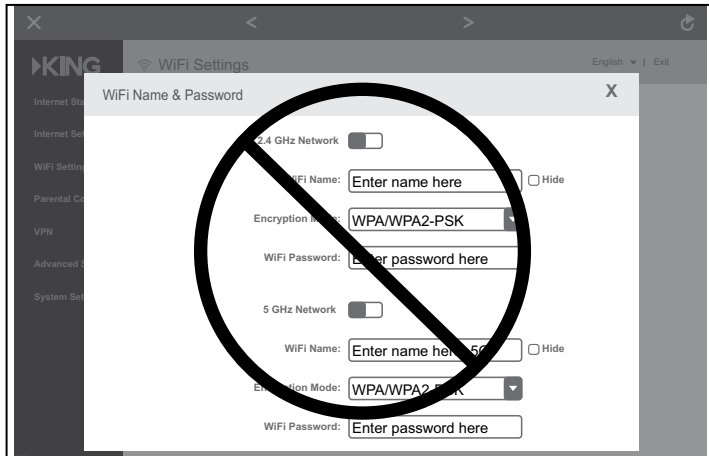

4. Follow the app instructions to locate the “KING WiFiMax Setup” screen (see page 11 if you don’t remember how to do this).

Tap on “KING WiFiMax Setup.”

5. This screen should appear. Tap “WiFi Settings” in the left-hand column.

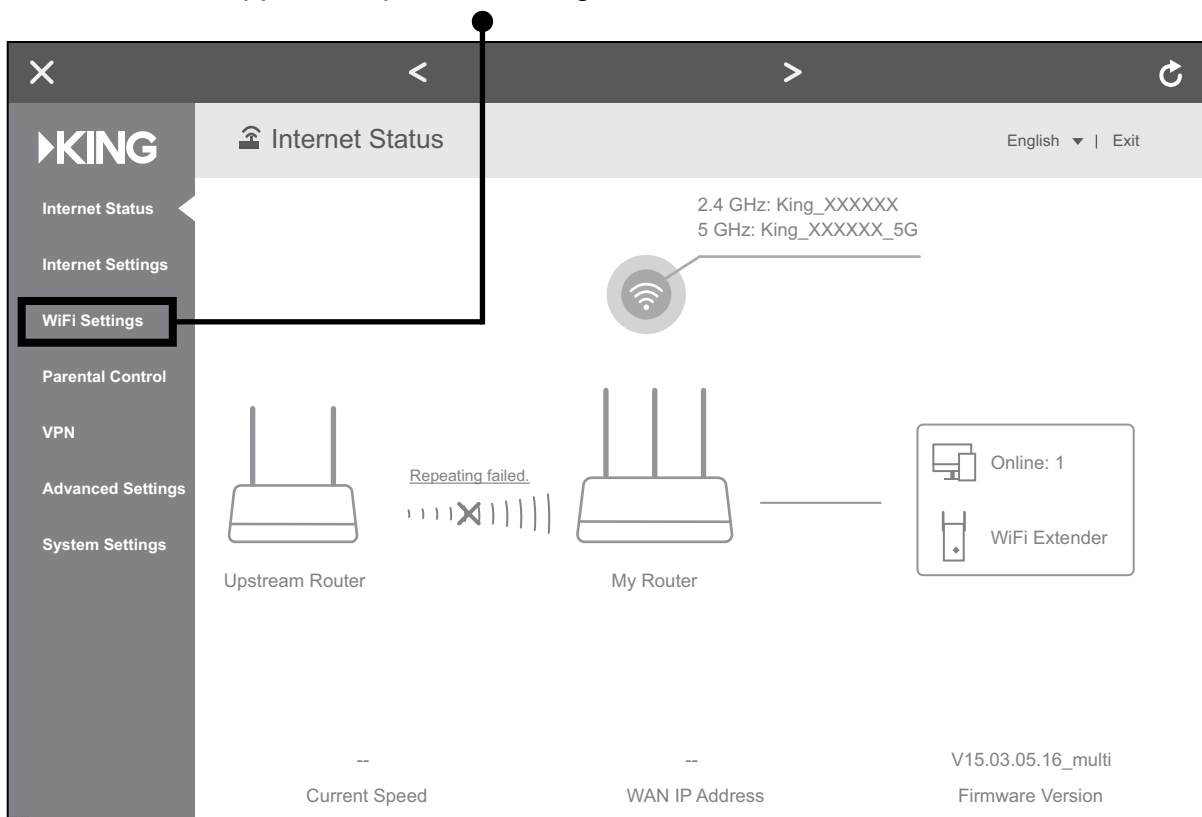

6. This screen should appear. Tap “Wireless Repeating.”

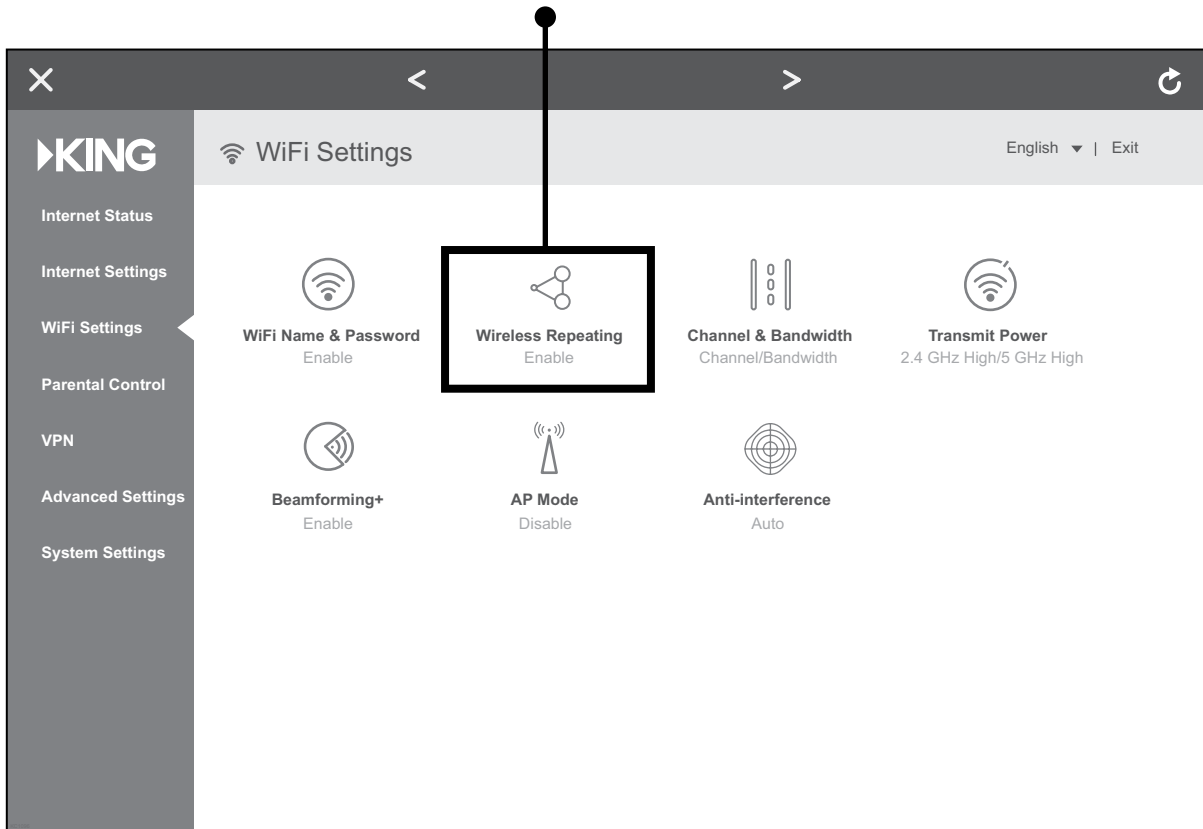

7. This screen should appear. Tap the blue arrows to scan for networks.

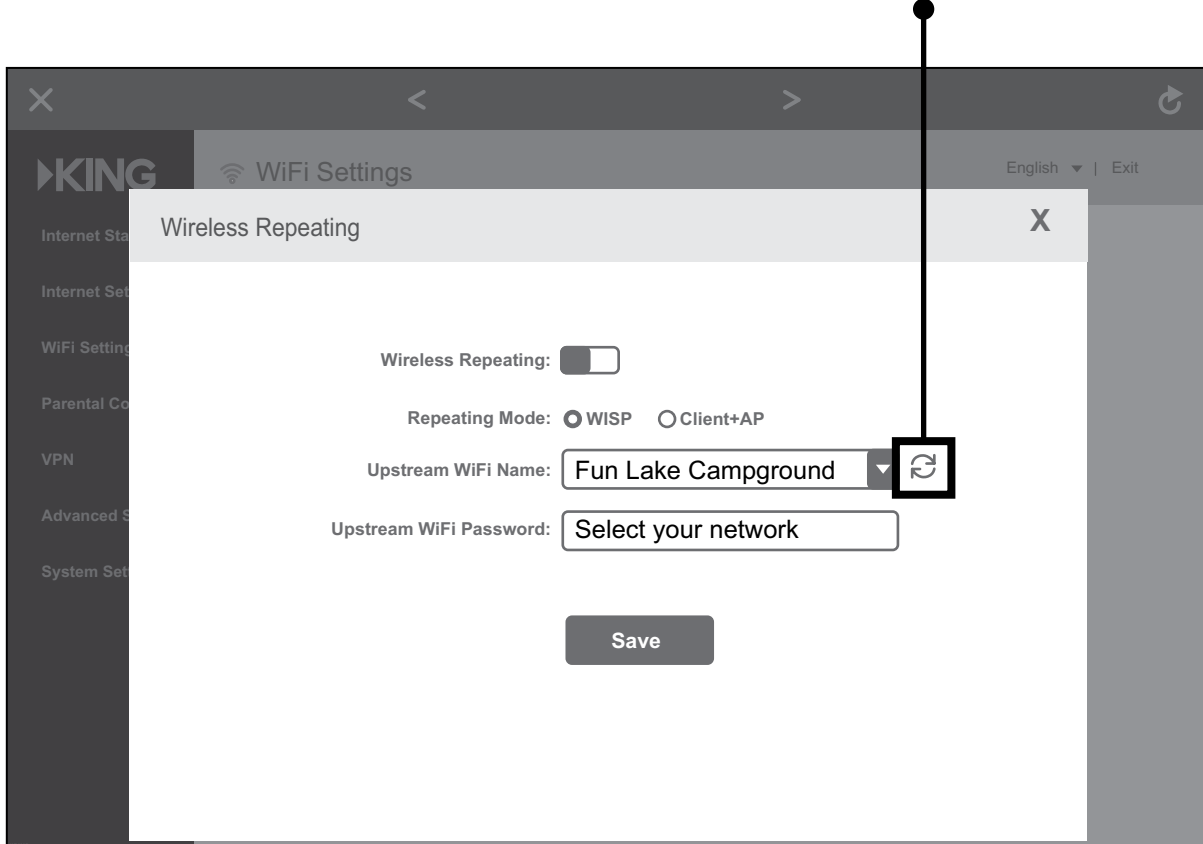

This screen should appear.

The router is scanning for networks.

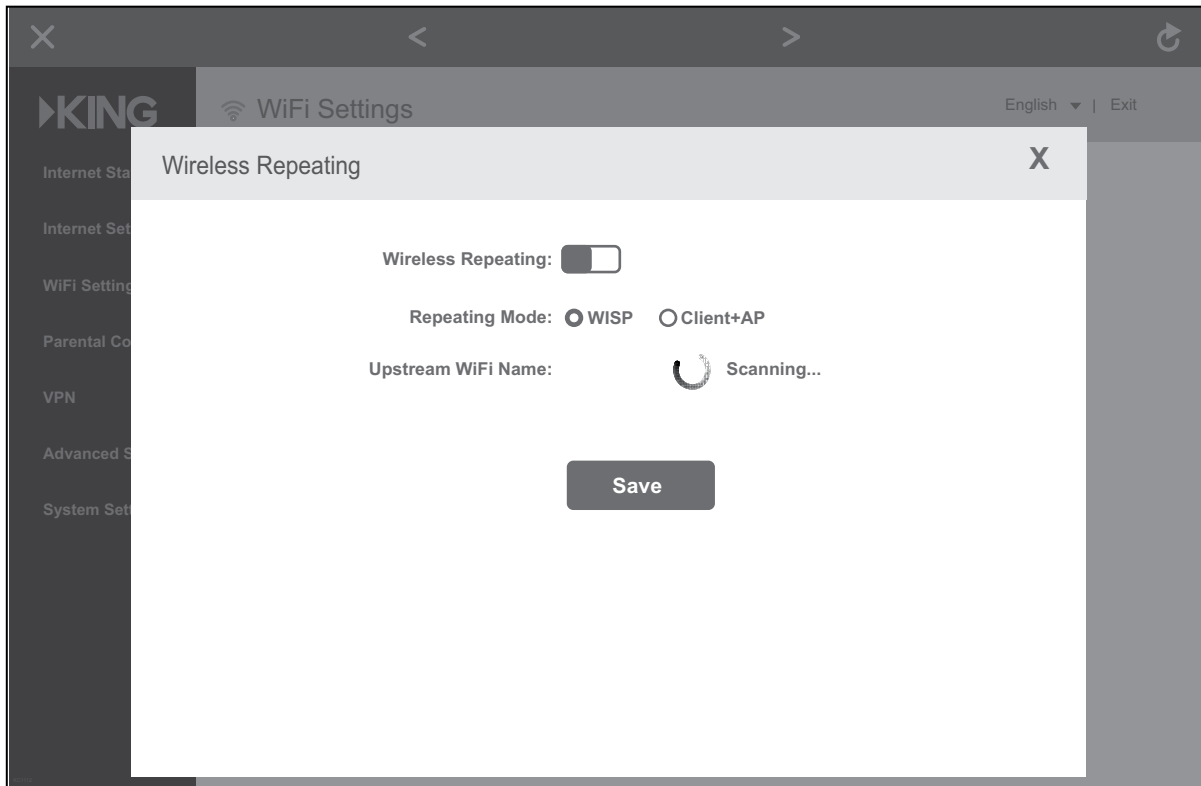

8. After the scanning process is complete, this screen should appear.

Tap the “Upstream WiFi Name” drop down menu to display a list of available networks.

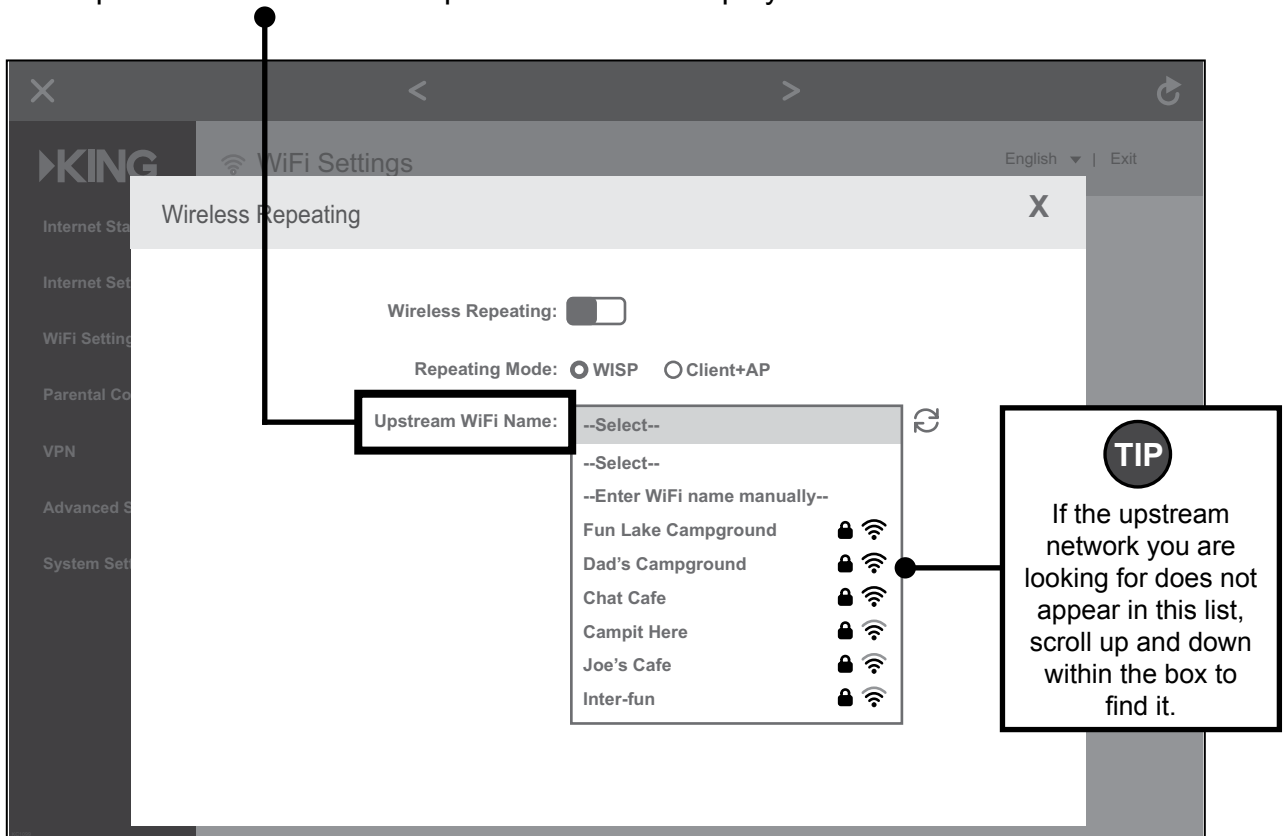

9. Select the same network as the one you pointed the KING Falcon at (page 17, step 3).

Example:

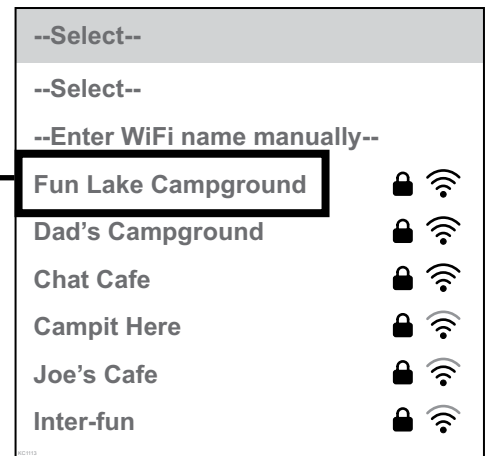
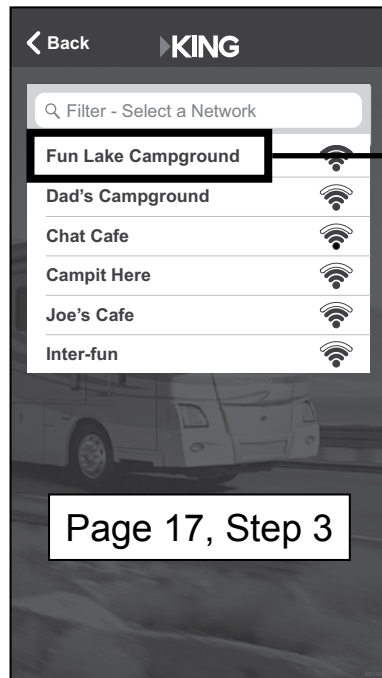

TIP Your upstream network may require a password (screen not shown).

Tap “Save.”

This popup should appear. Tap “OK.”

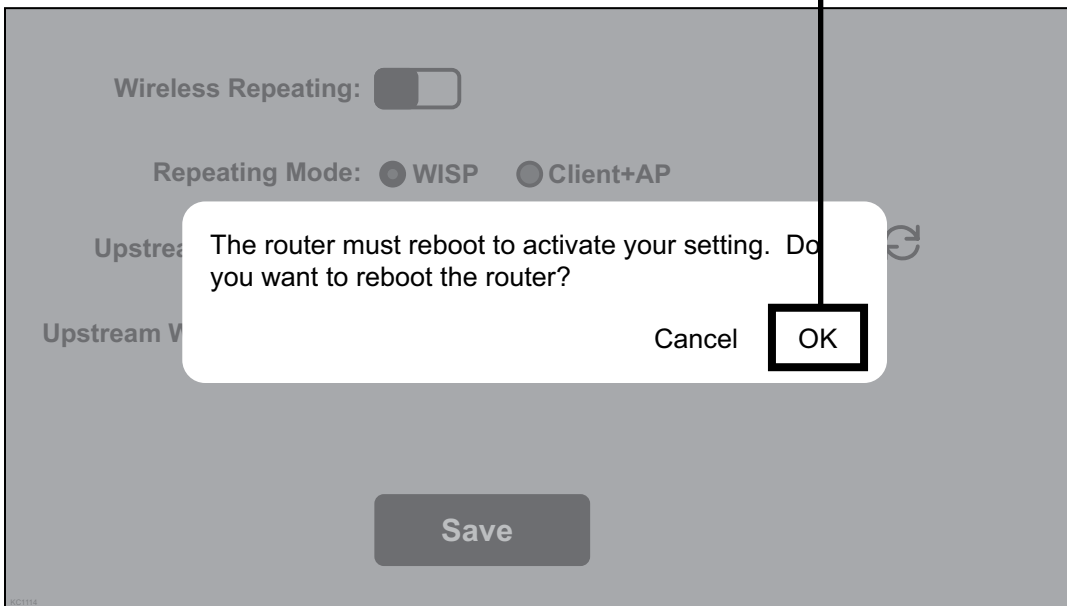

TIP You may have to zoom out or scroll down to see the progress.

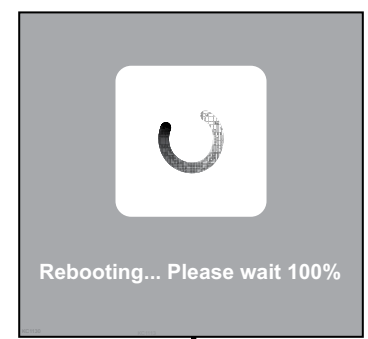

10. Your KING Wi-FiMax will reboot.



If your router gets stuck at 100% and won't finish rebooting, or if your Wi-Fi device does not have internet access, you may need to go back to your smart phone or tablet's settings page and ensure that it reconnected to the Wi-Fi network with your personalized network name (page 5), as you may lose connection during the router's rebooting process.

Your KING Wi-FiMax is now extending your network!

TIP If you turned off your cellular network during standard operation, it is now safe to turn it back on.

This page intentionally left blank.

INSTALLATION

TIP

Record KING Falcon serial number (located on back of base) on inside of cover before installing on roof.

CONTENTS

- KING Falcon antenna
- Power inserter with power supply
- Long exterior SMB cable
- Short interior RP-SMA cable
- White wall plate
- Black wall plate
- Installation and operating instructions
- KING WiFiMax router with power supply

IMPORTANT!

Appropriate fasteners and roof-compatible sealant to be determined and supplied by installer.

Read through the installation instructions before beginning. Determine the desired locations for the components using the information on these two pages. Locations will depend on such things as roof obstructions, cable runs between components, AC power availability and whether you will install the wall plates.

EXTERIOR

- For best performance, the antenna should be placed as far away from other rooftop objects (TV antennas, AC units, etc.) and with the best all around line of sight.
- The antenna should be mounted with the coax port towards the rear of the vehicle.
- There must be adequate space for the antenna head to rotate freely. The antenna should not rotate over other objects or rotate over the edge of the roof.

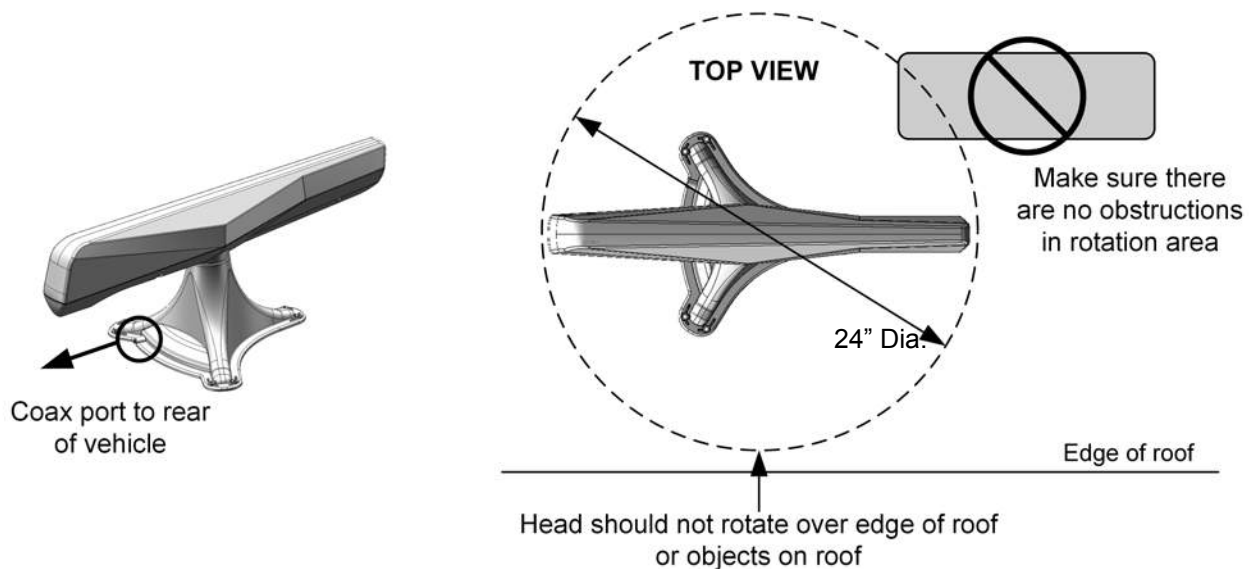

INTERIOR

- Do not locate interior components in a slide-out.
- Ensure supplied cables reach between components when placed in their installation locations.
- Ensure power inserter and KING WiFiMax router are located where their power supplies can be plugged into a 110 VAC outlet.
- The KING WiFiMax can be positioned on a stable surface or mounted to a wall.

EXTERIOR

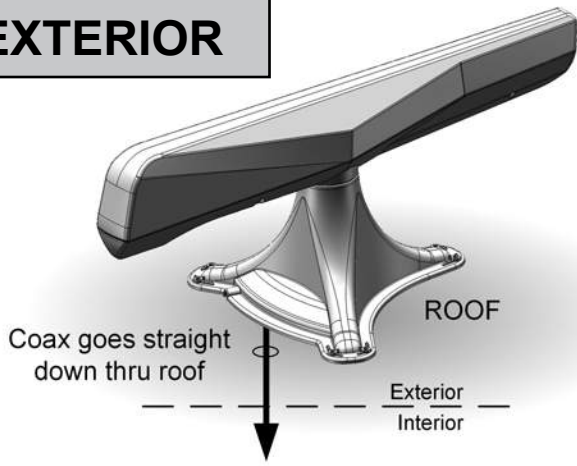

INSTALLATION OPTION 1: Concealed Cable (pages 24-25)

Coax enters vehicle directly under base mount.

OR

INSTALLATION OPTION 2: External Cable (pages 26-27)

Coax exits base mount in rear, is routed along roof, and enters vehicle outside of base mount perimeter.

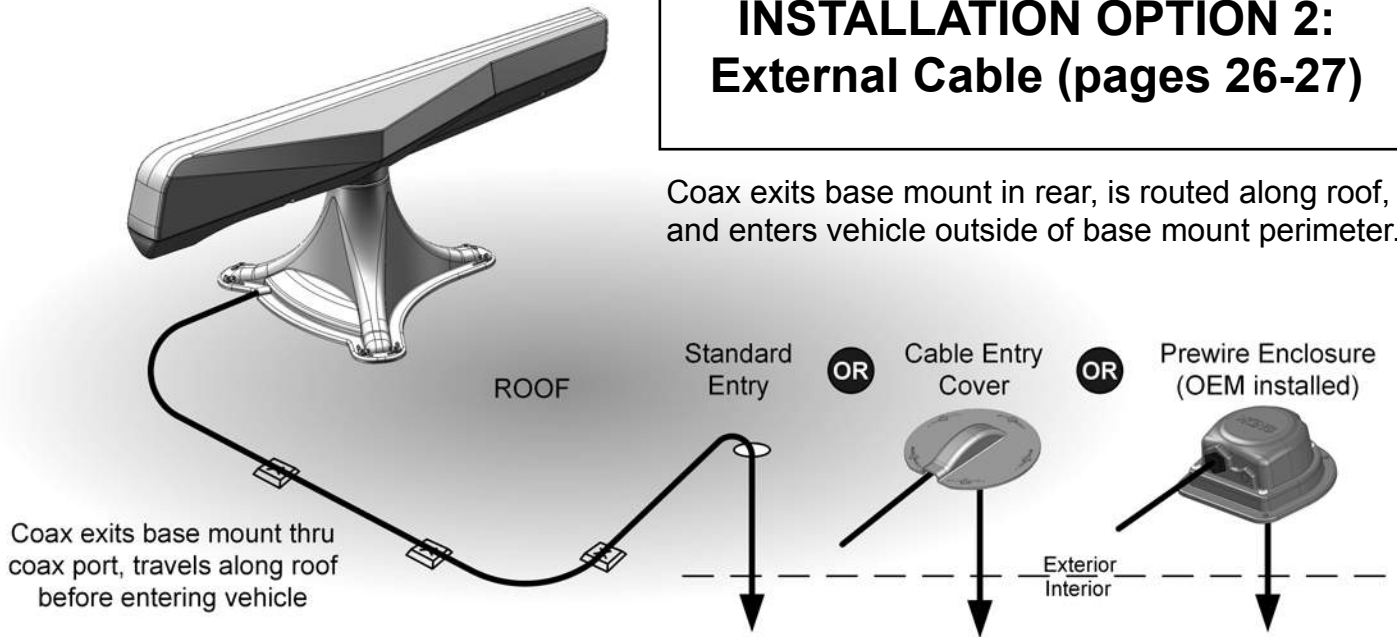

INTERIOR

Connections are the same regardless of where coax enters vehicle (pages 28-29)

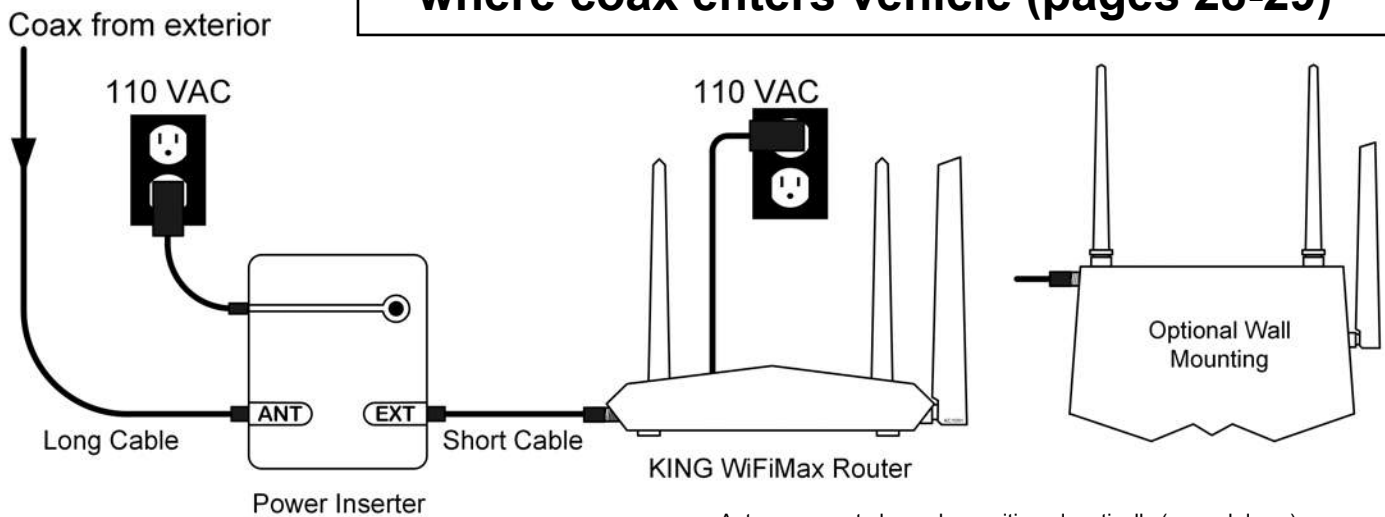

Antennas must always be positioned vertically (up and down).

INSTALLATION OPTION 1: Concealed Cable

IMPORTANT! The installer is responsible for determining and supplying the most appropriate fasteners to secure the base mount to the roof.

All holes, fastener heads, and the entire perimeter of the base mount (including coax port) must be completely sealed and weatherproofed with roof-compatible sealant.

AVOID SHARP BENDS WHEN ROUTING CABLE!

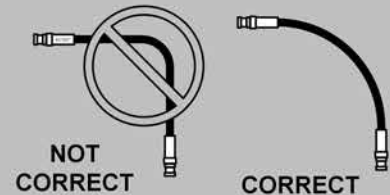

EXTERIOR

1. After establishing location of the antenna, drill a minimum 5/16" hole thru the roof where the cable will enter the vehicle. Make sure to locate hole so it is not covered by the circuit board when the antenna is set in place (Fig. 1).

IMPORTANT! The cables have different connectors on each end. Match the proper end of cables to the components before routing.

2. Feed the long cable thru the hole (from inside or outside) leaving about two feet sticking out of roof. Place all components and cables in position and make sure cables can reach all components.
3. **DO NOT TOUCH CIRCUIT BOARD AT ANY TIME!** Feed long cable under the circuit board as shown in the Fig. 2. Leave as large a bend as possible in the cable and push the cable connector onto the circuit board connector until it clicks in place (hold the cable by the connector and not the actual cable).
4. Fig. 3: Apply sealant around entire perimeter of base mount and fill coax port on rear of base mount.
5. Feed cable down thru roof hole as you lower the base mount into position.
6. Fasten base mount to roof with appropriate fasteners. Seal (6) fastener heads.

INTERIOR (Go to page 28)

INSTALLATION OPTION 1: Concealed Cable

FIG. 1

Locate roof hole next to coax port.

Hole must not be too close to circuit board.

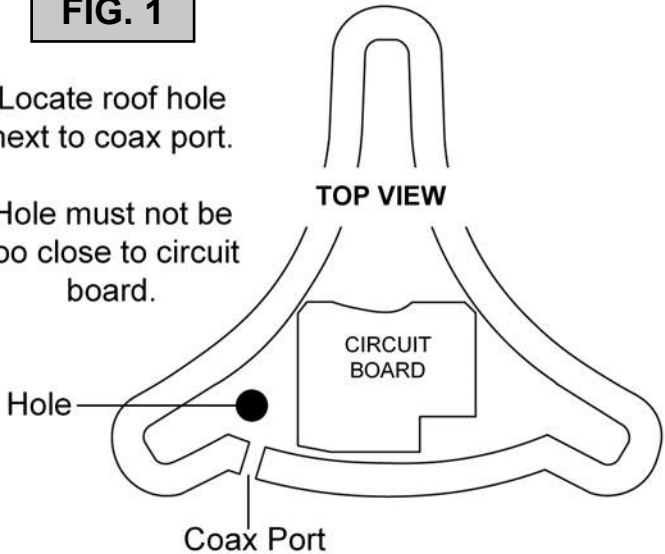

FIG. 2



KEEP BEND IN CABLE AS LARGE AS POSSIBLE!



FIG. 3

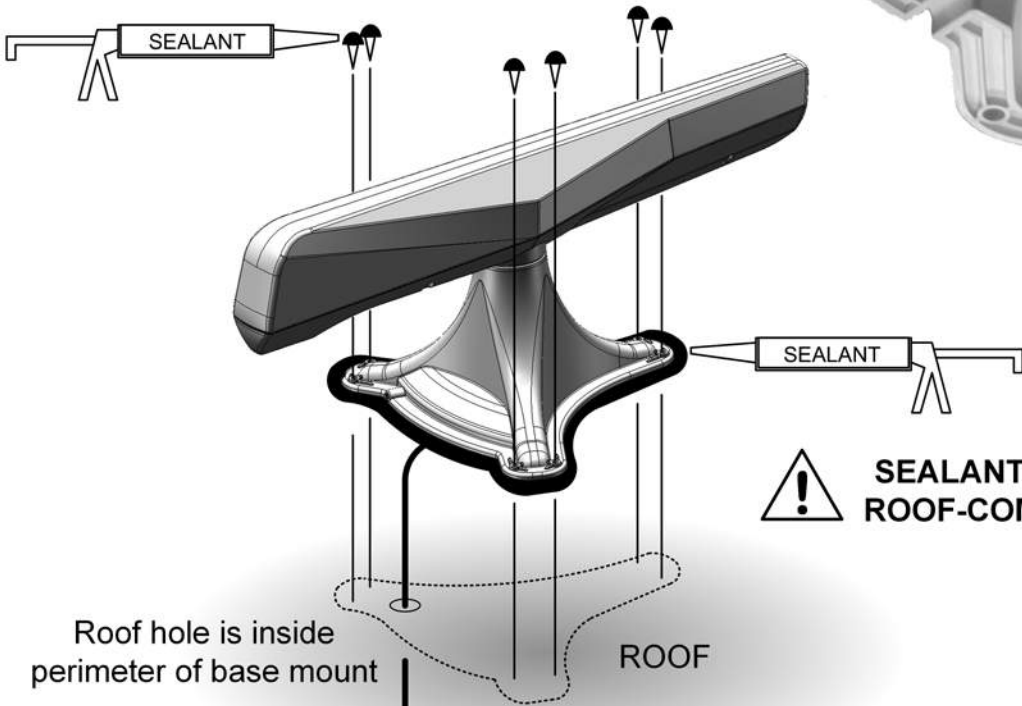

SEALANT MUST BE ROOF-COMPATIBLE!

Exterior
Interior

SEE PAGE 28



NO SHARP BENDS!



INSTALLATION OPTION 2: External Cable

IMPORTANT! The installer is responsible for determining and supplying the most appropriate fasteners to secure the base mount and coax to the roof.

All holes, fastener heads, and the entire perimeter of the base mount (including coax port) must be completely sealed and weatherproofed with roof-compatible sealant.

AVOID SHARP BENDS WHEN ROUTING CABLE!

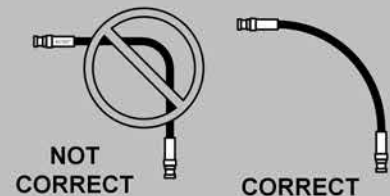

EXTERIOR

IMPORTANT! The cables have different connectors on each end. Match the proper end of cables to the components before routing.
If using the prewire enclosure, you will not do steps 1, 2 and 7 (see Fig. 3).

1. Drill a minimum 5'16" hole where cable will go thru roof.
2. Feed the long cable thru the hole (from inside or outside) Place all components and cables in position, leaving enough cable sticking out of roof to reach both antenna (outside) and power inserter (inside).
3. **DO NOT TOUCH CIRCUIT BOARD AT ANY TIME!** Feed cable under the circuit board as shown in the Fig. 1. Leave as large a bend as possible in the cable and push the cable connector onto the circuit board connector until it clicks in place (hold the cable by the connector and not the actual cable).
4. Fig. 2. Apply sealant around entire perimeter of base mount and fill coax port on rear of base mount. Make sure you fill coax port with sealant before placing cable in it to ensure complete sealing of coax port.
5. Place cable in coax port and place the base mount in position.
DO NOT PINCH COAX UNDER EDGE OF BASE MOUNT WHEN PLACING ON ROOF.
6. Fasten base mount to roof with appropriate fasteners. Seal (6) fastener heads.
7. Seal roof hole so it is completely waterproof (the optional cable entry cover provides additional protection for the cable entry point - see your dealer or *kingconnect.com*).
8. Fasten cable to roof every 12-18" (hardware determined and supplied by installer).

INTERIOR (Go to page 28)

INSTALLATION OPTION 2: External Cable

FIG. 2

! SEALANT MUST BE ROOF-COMPATIBLE!

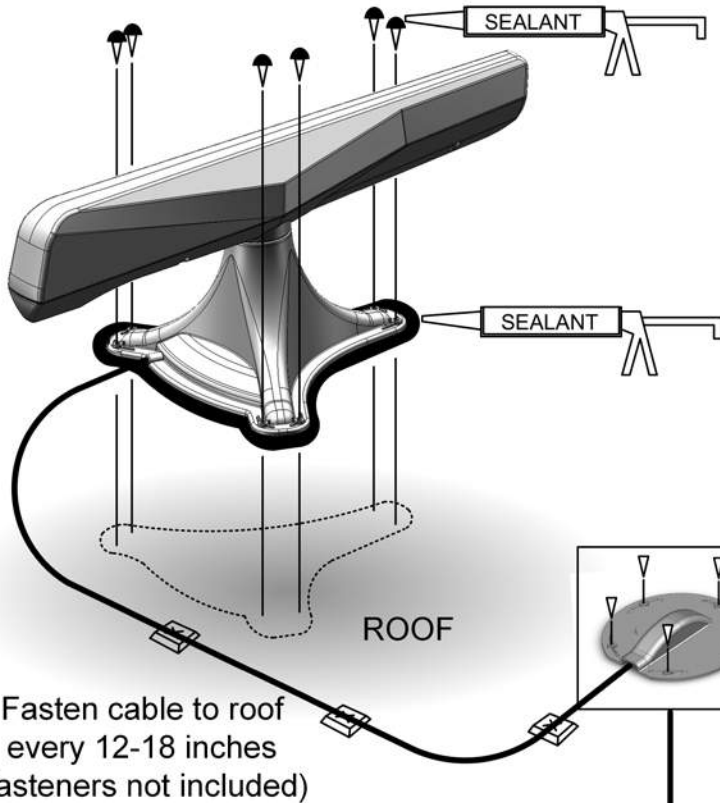
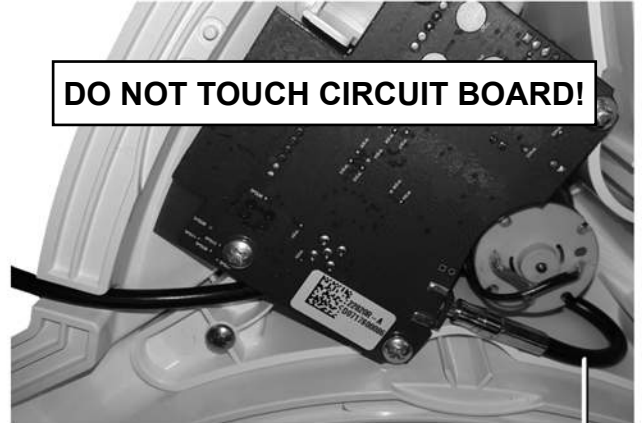

FIG. 1

Cable exits base mount towards rear of vehicle and is routed to entry point

DO NOT TOUCH CIRCUIT BOARD!



! KEEP BEND IN CABLE AS LARGE AS POSSIBLE!

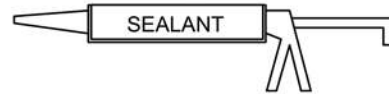

Optional Cable Entry Cover shown (see satellite accessories page on KING website)

Exterior
Interior

SEE PAGE 28

FIG. 3

Prewire connections with OEM installed prewire enclosure

1. Remove (4) screws and take off the prewire cap.
2. Knock out the hole for the watertight connector.
3. Take the nut off the watertight connector.
4. Feed the cable through the nut, prewire cap, and connector.
5. Install the connector in the prewire cap with the nut.
6. Feed desired amount of cable through connector and tighten the connector's sealing nut.
7. Replace the prewire cap and fasten with (4) screws.
DO NOT OVER-TIGHTEN SCREWS INTO PLASTIC.

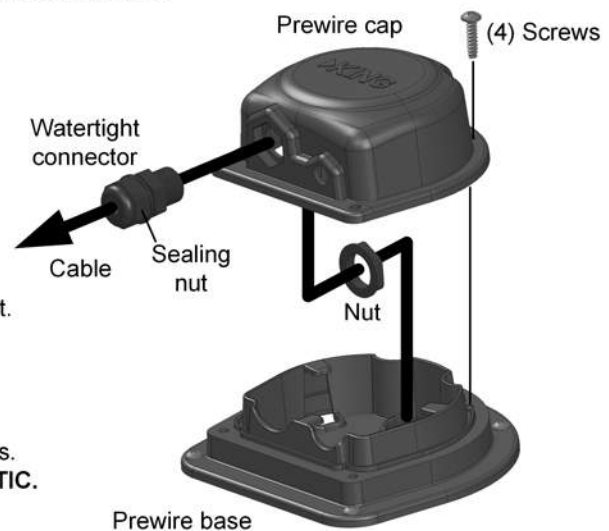

INTERIOR CONNECTIONS

1. Make connections as shown (install wall plate if desired).
2. Rotate 3 antennas into upright position (antennas must be vertical whether the KING WiFiMax is placed on a flat surface or wall mounted).
3. Plug in power inserter and KING WiFiMax.

NOTE: You can wall mount the KING WiFiMax using the keyhole slots in the back. Always orient the antennas vertically.

INTERIOR CONNECTIONS



ANTENNAS MUST ALWAYS BE POSITIONED VERTICALLY (UP AND DOWN)!

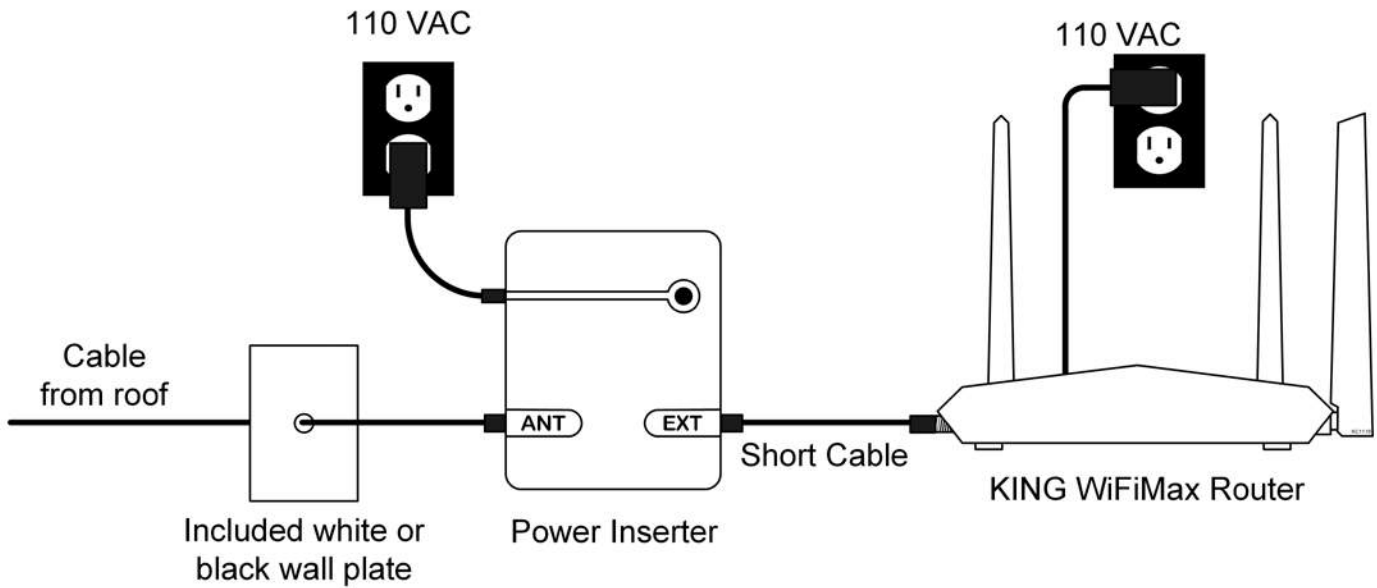

If there is a prewire enclosure on the roof, you will find a preinstalled wall plate. Remove this plate and replace it with the included white or black wall plate.



ANTENNAS MUST ALWAYS BE POSITIONED VERTICALLY (UP AND DOWN)!

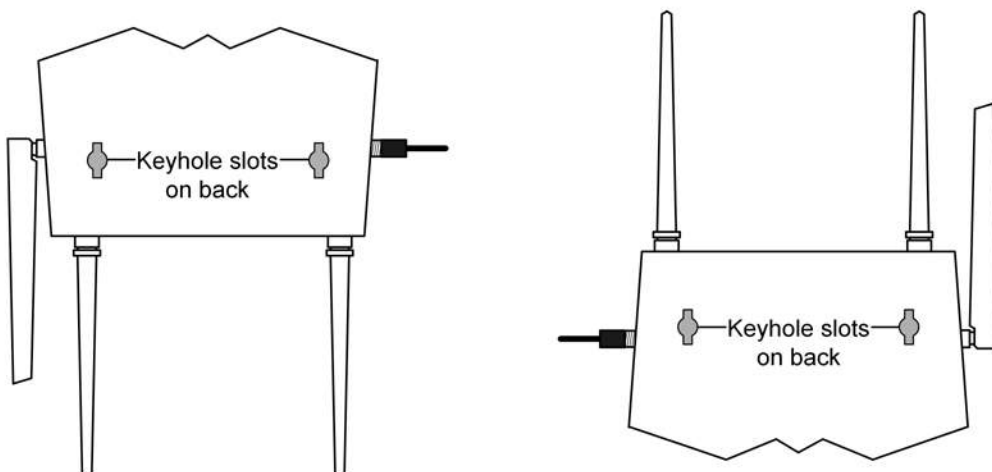

TROUBLESHOOTING

The KING WiFiMax doesn't power on (no blue lights on front).

Make sure power supply plug is securely inserted into back of KING WiFiMax. Make sure the power supply is plugged into a known good power outlet.

I can't find the network KING_XXXXXX_5G or KING_XXXXXX.

Make sure your KING WiFiMax is plugged in. It may take up to a minute for these networks to appear. Some older devices may be unable to see the 5GHz network. This is completely okay; just use the KING_XXXXXX network.

I can't access the KING WiFiMax setup screen.

Go to your smart phone or tablet's settings page and make sure you are connected to your KING WiFiMax's network.

I can't enter a password in the designated box.

Choose WPA/WPA2-PSK under "Encryption Mode" (right above the password box) to enable password protection.

When I tap on Upstream WiFi Name I don't see the network I want in the list of networks.

If there are more networks in the list than can appear in the box, you will need to scroll up or down in the box to see them all.

If a network is very far away or very weak, the KING WiFiMax may not be able to see it, or may not offer it as an option. Try scanning again for networks by clicking on the blue circular arrows. If your network is still not offered as an option, try moving your KING WiFiMax to a location closer to your desired network.

When my router reboots, it gets stuck at 100% and won't finish rebooting.

Try reloading the page. (If the page won't load, make sure your device is still connected to the KING WiFiMax. It may have disconnected during the reboot.)

The KING WiFiMax doesn't seem to extend the range of my Wi-Fi, or has trouble picking up signal from my source.

Make sure all 3 antennas are pointing up. If wall mounting, antennas must be rotated to point up (or down) as well.

Certain types of obstructions (other vehicles, buildings, or large amounts of metal) can reduce signal levels. Try relocating the KING WiFiMax.

Let us help!

KING Customer Service

952-345-8147

SPECIFICATIONS

KING FALCON ANTENNA SPECIFICATIONS

Antenna:	Antenna Weight: 2.7 lbs. Antenna Dimensions: 9.18" H x 10.95" W x 22.65" L
Wireless Standards:	IEEE 802.11b IEEE 802.11g IEEE 802.11n
Radio Frequency Band:	2.4GHz
Antennas:	(1) 15dBi Yagi-type Antenna (Self-Aiming, Internal, iOS or Android Controlled) (1) Internal Bluetooth Low Energy Antenna
Amplifiers:	(1) 2.4 GHz Radio Power Amplifier for Bluetooth LE
Antenna Connector Type:	(1) RP-SMA to Connect Indoor Wall Plate to Wi-Fi Extender
Power Supply Rating:	Input: Voltage: 12VDC Nominal, 16VDC Max. Current: 500mA Max
Setup Requirements:	Tablet, Smartphone, or similar device with Bluetooth Low Energy Capability running Apple iOS or Android

KING WIFIMAX ROUTER SPECIFICATIONS

Power:	Included 12v power supply, requiring 110V AC plug-in
Wireless standards:	IEEE802.11a/b/g/n/ac
Supported Frequencies:	2.4GHz and 5GHz (dual-band)
Security:	WPA/WPA2-PSK
Storage Environment:	Temperature -40°F to 158°F

IMPORTANT! Do not power wash any part of the KING Falcon antenna head or base mount.

LIMITED WARRANTY

Every new KING Falcon/KING WiFiMax is thoroughly inspected and tested before leaving the factory, and is covered by the following limited warranty from the date of original purchase:

- KING Falcon
- Two-year parts warranty: The customer is not responsible for the cost of replacement parts if the original part is determined to be defective under the terms of the warranty. The customer is responsible for the cost of replacement parts after two years.
 - One-year labor warranty: The customer is not responsible for labor costs to repair unit if unit falls under the terms of the warranty. Any warranty labor outside of that performed at the factory is not covered unless the product has been installed by an authorized dealer/installer or OEM manufacturer. The customer is responsible for all labor costs after one year.
- KING WiFiMax
- One-year parts warranty: The customer is not responsible for the cost of replacement parts if the original part is determined to be defective under the terms of the warranty. The customer is responsible for the cost of replacement parts after one year.

Only KING and certified dealers may perform warranty evaluations and repairs. Depending upon the problem, KING may authorize a dealer to perform the necessary repairs. Any warranty labor outside of that performed at the factory is not covered unless 1) the product has been installed by an authorized dealer/installer or OEM manufacturer and 2) the dealer/installer receives prior authorization to perform the repair.

A certified dealer must not perform any repair without first contacting KING for a Service Order Number. KING will advise the dealer on how to proceed with any repairs.

Should any trouble develop during the warranty period, contact KING at (952) 922-6889. You must contact KING before the warranty period expires. The customer must supply proof of purchase (such as a dated sales receipt) when requesting warranty service. If the customer cannot supply proof of purchase, warranty period shall start 30 days after date of manufacture.

If it is determined that the unit needs to be returned to KING, customer must return COMPLETE product, freight prepaid, to: **KING, 11200 Hampshire Avenue South, Bloomington, MN 55438-2453.**

If inspection shows the trouble is caused by defective workmanship or material, KING will repair (or at its option, replace) without charge.

When returning product, KING will supply an RMA number (Return Merchandise Authorization). This number must be clearly written on the box. Failure to clearly write RMA number on box may result in delays in processing claim. Along with product, customer should include in the box: his/her name, address, daytime phone number, proof of purchase and description of the problem.

This warranty does not cover installation and external wiring, or remanufactured units. This warranty does not cover damage caused by the use of an accessory other than a KING accessory designed for the product. This warranty is not transferable from the original owner.

KING cannot be held responsible for changes in the expanding and changing digital and analog communications market that cause the product to no longer operate correctly.

This warranty also does not apply where:

- The product has been abused, misused, improperly installed or improperly maintained.
- The product has been used with an accessory other than a KING accessory designed for the product.
- Repairs have been made or attempted by others that are not certified by KING to do such repairs.
- Repairs are required because of normal wear and tear.
- Alterations have been made to the product.
- The product or any associated component has been opened without authorization or disassembled to any degree.
- Damage has been caused by power washing.
- Circumstances beyond the control of KING cause the product to no longer operate correctly.
- Customer is not the original owner.

In no event shall KING be liable for any indirect, incidental, or consequential damages from the sale or use of the product. This disclaimer applies both during and after the term of this warranty.

KING disclaims liability for any implied warranties, including implied warranties of “merchantability” and “fitness for a specific purpose,” after the term of this warranty.

This warranty gives you specific legal rights, and you may also have other rights, which vary from state to state. Some states do not allow the exclusion or limitation of incidental or consequential damages, so the above limitation or exclusion may not apply to you. Some states do not allow limitations on how long an implied warranty lasts, so the above limitation may not apply to you.

WIRELESS REGULATORY INFORMATION

FCC Statement

This device complies with part 15 of the FCC Rules. Operation is subject to the following two conditions: (1) This device may not cause harmful interference, and (2) this device must accept any interference received, including interference that may cause undesired operation.

Note: This equipment has been tested and found to comply with the limits for a Class B digital device, pursuant to part 15 of the FCC Rules. These limits are designed to provide reasonable protection against harmful interference in a residential installation. This equipment generates, uses and can radiate radio frequency energy and, if not installed and used in accordance with the instructions, may cause harmful interference to radio communications. However, there is no guarantee that interference will not occur in a particular installation. If this equipment does cause harmful interference to radio or television reception, which can be determined by turning the equipment off and on, the user is encouraged to try to correct the interference by one or more of the following measures:

- Reorient or relocate the receiving antenna.
- Increase the separation between the equipment and receiver.
- Connect the equipment into an outlet on a circuit different from that to which the receiver is connected.
- Consult the dealer or an experienced radio/TV technician for help.

FCC Caution

Any changes or modifications not expressly approved by the party responsible for compliance could void the user's authority to operate this equipment.

This transmitter must not be co-located or operating in conjunction with any other antenna or transmitter.

IEEE 802.11b or 802.11g operation of this product in the USA is firmware-limited to channels 1 through 11.

The device for the band 5150-5250 MHz is only for indoor usage to reduce the potential for harmful interference to co-channel mobile satellite systems.

Radiation Exposure Statement

This device complies with FCC radiation exposure limits set forth for an uncontrolled environment and it also complies with Part 15 of the FCC RF Rules. This equipment should be installed and operated with minimum distance 20 cm between the radiator and your body.

Innovation, Science and Economic Development Canada Statement

CAN ICES-3 (B)/NMB-3(B)

This device contains licence-exempt transmitter(s)/receiver(s) that comply with Innovation, Science and Economic Development Canada's licence-exempt RSS(s). Operation is subject to the following two conditions: (1) This device may not cause interference, and (2) This device must accept any interference, including interference that may cause undesired operation of the device.

For product available in the USA/Canada market, only channel 1-11 can be operated. Selection of other channels is not possible.

The device could automatically discontinue transmission in case of absence of information to transmit, or operational failure. Note that this is not intended to prohibit transmission of control or signaling information or the use of repetitive codes where required by the technology.

Innovation, Science and Economic Development Canada Radiation Exposure Statement

This equipment complies with ISED radiation exposure limits set forth for an uncontrolled environment. This equipment should be installed and operated with minimum distance 20 cm between the radiator and your body.

This device and its antenna(s) must not be co-located or operating in conjunction with any other antenna or transmitter except in accordance with ISED multi-transmitter product procedures.

Restrictions in the 5 GHz Band

The device for the band 5150-5250 MHz is only for indoor usage to reduce the potential for harmful interference to co-channel mobile satellite systems.

The maximum antenna gain permitted for devices in the band 5725-5825 MHz shall comply with the e.i.r.p. limits specified for point-to-point and non point-to-point operation as appropriate.

Users should also be advised that high-power radars are allocated as primary users (i.e. priority users) of the bands 5250-5350 MHz and 5650-5850 MHz and that these radars could cause interference and/or damage to LE-LAN devices.

This radio transmitter (6873A-KWM1000) has been approved by Innovation, Science and Economic Development Canada to operate with the antenna types listed below with the maximum permissible gain indicated. Antenna types not included in this list that have a gain greater than the maximum gain indicated for any type listed are strictly prohibited for use with this device.

Detachable antenna:

- 5 dBi at 2.4 GHz, 50Ω, Dipole
- 8.48 dBi at 2.4 GHz, 50Ω, Yagi

Additional requirements for the band 5600-5650 MHz

Until further notice, devices subject to this Section shall not be capable of transmitting in the band 5600-5650 MHz, so that Environment Canada weather radars operating in this band are protected.

Avis d'Innovation, Sciences et Développement économique Canada

CAN ICES-3 (B)/NMB-3(B)

L'émetteur/récepteur exempt de licence contenu dans le présent appareil est conforme aux CNR d'Innovation, Sciences et Développement économique Canada applicables aux appareils radio exempts de licence. L'exploitation est autorisée aux deux conditions suivantes : (1) L'appareil ne doit pas produire de brouillage; et (2) L'appareil doit accepter tout brouillage radioélectrique subi, même si le brouillage est susceptible d'en compromettre le fonctionnement.

Pour les produits disponibles sur le marché aux États-Unis et au Canada, seuls les canaux de 1 à 11 peuvent être utilisés. La sélection d'autres canaux n'est pas possible.

Le dispositif peut automatiquement cesser d'émettre en cas d'absence d'informations à transmettre, ou à cause d'une défaillance technique. Notez que l'objet n'est pas d'interdire la transmission des informations de contrôle ou de signalisation ou l'utilisation de codes répétitifs lorsque requis par la technologie.

Avis d'Innovation, Sciences et Développement économique Canada concernant l'exposition aux radiofréquences

Ce matériel est conforme aux limites établies par ISED en matière d'exposition aux radiofréquences dans un environnement non contrôlé. Ce matériel doit être installé et utilisé à une distance d'au moins 20 cm entre l'antenne et le corps de l'utilisateur.

Cet appareil et son (ses) antenne(s) ne doivent pas être situés à proximité ou fonctionner en association avec une autre antenne ou un autre émetteur autre qu'en respectant les procédures d'ISED relatives au fonctionnement des dispositifs multi-émetteurs.

Restrictions dans la bande 5 GHz

L'appareil pour la bande de 5150 à 5250 MHz est conçu pour usage à l'intérieur seulement afin de réduire le potentiel d'interférences pour les systèmes mobiles par satellite qui utilisent le même canal.

Le gain maximal d'antenne permis (pour les dispositifs utilisant la bande 5725-5825 MHz) doit se conformer à la limite de p.i.r.e. spécifiée pour l'exploitation point à point et non point à point, selon le cas.

De plus, les utilisateurs devraient aussi être avisés que les utilisateurs de radars de haute puissance sont désignés utilisateurs principaux (c.-à-d., qu'ils ont la priorité) pour les bandes 5250-5350 MHz et 5650-5850 MHz et que ces radars pourraient causer du brouillage et/ou des dommages aux dispositifs LAN-EL.

Le présent émetteur radio (6873A-KWM1000) a été approuvé par Innovation, Sciences et Développement économique Canada pour fonctionner avec les types d'antenne énumérés ci-dessous et ayant un gain admissible maximal. Les types d'antenne non inclus dans cette liste, et dont le gain est supérieur au gain maximal indiqué pour tout type figurant sur la liste, sont strictement interdits pour l'exploitation de l'émetteur.

Antenne détachable:

- 5 dBi à 2.4 GHz, 50Ω, Dipôle
- 8.48 dBi à 2.4 GHz, 50Ω, Yagi

Prescriptions supplémentaires pour la bande 5600-5650 MHz

Jusqu'à nouvel ordre, les appareils faisant l'objet de la présente section ne doivent pas transmettre dans la bande 5600-5650 MHz, afin que les radars météorologiques d'Environnement Canada fonctionnant dans cette bande soient protégés.

Simply better, by design.™



11200 Hampshire Avenue South, Bloomington, MN 55438
PH 952.922.6889 || FAX 952.922.8424 || kingconnect.com

© 2018 KING 22872 Rev B

All trademarks are the sole property of their respective owners.