

Wherever You Go...We Go!

Tiffin Motorhomes

Experience a lifetime relationship!



PowerGlide Chassis Allegro Breeze Owner's Manual

Tiffin Motorhomes, Inc.

105 2nd Street NW

Red Bay, AL 35582 U.S.A.

Phone: (256) 356-8661 E-Mail: info@tiffinmotorhomes.com

[20110701]

TIFFIN MOTORHOMES, INC.

105 2nd Street NW ♦ Red Bay, Alabama 35582 U.S.A.

PowerGlide® Owner's Manual

TIFFIN MOTORHOMES, INC.

Allegro Breeze Chassis Owner's Manual

© Tiffin Motorhomes, Inc.
105 2nd Street NW, Red Bay, AL 35582 U.S.A.
Telephone 256.356.8661 • Facsimile 256.356.8219
E-Mail: info@tiffinmotorhomes.com

DISCLAIMER

Many of the features and appliances described in this manual may or may not be reflected in the actual motor home purchased, depending on the options and models selected by the motorhome owner. All items, materials, instructions, and guidance described in this manual are as accurate as possible at the time of printing. However, because of Tiffin Motorhomes' ongoing and dedicated commitment to excellence, improvement of Tiffin motorhomes is a continuing process. Consequently, Tiffin Motorhomes reserves the right to make substitutions and improvements in its makes and models of motorhomes without prior notification. Substitutions of comparable or better materials, finishes, appliances, instrumentation, and instruction may be made at any time it is deemed prudent to provide the customer with the best possible motorhome meeting the customer's requirements.

Copyright © 2011 by Tiffin Motorhomes, Inc. -- all rights reserved

Printed in the United States of America: Fifth U.S. Printing: July 2011

[20110710]

**Allegro Breeze Tiffin PowerGlide Chassis
Customer Support
256-356-0261
Monday-Friday
7 a.m. - 4:30 p.m. CST**

If you should require chassis service, *you should first contact your nearest Tiffin Powerglide® Chassis service center.* If for some reason this is not possible or if you would like to call the manufacturers direct, you can contact them at the following telephone numbers:

TIFFIN POWERGLIDE CHASSIS

256-356-0261

(Please have your VIN# ready)

COACH-NET

(Nights and weekends)

1-866-590-5937

NAVISTAR ENGINE SUPPORT

<http://maxxforce.com/Dealers>

1-800-44-TRUCK (87825)

ALLISON TRANSMISSIONS

1-800-524-2303

MICHELIN TIRE

800-TIRE-HELP (800-847-3435)

Visit our website at www.tiffinmotorhomes.com

Table of Contents

<hr/> Chapter 1 <hr/>		<hr/> Chapter 5 <hr/>	
Tire Care		Instruments and Controls	
Tire Care	1-2	DPS Instrument Cluster Operation	5-2
Correct Tire Pressure	1-3	Appendix A	5-14
<hr/> Chapter 2 <hr/>		Appendix B	5-15
Brake System		Appendix C	5-16
Brake System	2-2	Appendix D	5-17
Compressed Air System	2-3	<hr/> Chapter 6 <hr/>	
Air Dryer	2-4	Warranty	
<hr/> Chapter 3 <hr/>		Pre-Trip Inspection	6-2
Scheduled Maintenance		<hr/> Chapter 7 <hr/>	
Scheduled Maintenance Chart	3-2	Allegro Owner's Club	
Lubrication Points	3-5	Allegro Owner's Club	7-2
Maintenance Parts	3-9	<hr/> Chapter 8 <hr/>	
Tiffin Assistance	3-10	Suggestions	
<hr/> Chapter 4 <hr/>		Send Us Your Suggestions	8-2
Pre-Trip Inspection			
Pre-Trip Inspection	4-2		

TIRE CARE

TIRE CARE

- What is the most important component of tire care?
 - ✓ TIRE PRESSURE
 - Why?
 - ✓ Improved Ride
 - ✓ Improved Tire Wear
 - ✓ Improved Road Handling
 - ✓ Improved Braking



Tire Care

Maintaining the proper tire inflation pressure is the most important thing you can do to maximize the life of your tires. An under-inflated tire can build up excessive heat that may go beyond the prescribed limits of endurance of the rubber and the radial cords. Over-inflation will reduce the tire's footprint on the road, reducing traction, braking capacity, and the handling of your vehicle. An over-inflated tire will also cause a harsh ride, uneven tire wear, and will be more susceptible to impact damage.

Keep in mind that the pressure rating on the side wall of your tire is the *maximum* pressure for that tire. This is not necessarily the *correct* pressure for the tires when installed on *your* vehicle. Maintaining the correct tire pressure for *your vehicle's loaded weight* is extremely important and must be a part of regular vehicle maintenance.

Correct Tire Pressure

- How to determine the correct pressure
 - ✓ Weigh each wheel position
 - ✓ Set tire pressure according to chart



* This Chart Shows Cold Inflation Pressures

265/70 R19.5 XZE2+

Load per Axle

	PSI=>	65	70	75	80	85	90	95	100	105	110	Max Load per Tire
		KPA=>	450	480	520	550	590	620	660	690	720	
Single	LBS	7,230	7,680	8,110	8,540	8,970	9,390	9,800	10,210	10,620	11,020	5,510
Dual	LBS	13,660	14,500	15,320	16,140	16,940	17,740	18,520	19,300	20,060	20,820	5,205
Single	KG	3,280	3,460	3,700	3,860	4,080	4,240	4,460	4,620	4,780	5,000	2,500
Dual	KG	6,200	6,520	6,960	7,280	7,720	8,040	8,440	8,720	9,040	9,440	2,360

To determine the correct air pressure for your tires, load your motor home as you would normally travel, including water and fuel. Go to a truck scale as found at most major truck stops and weigh **each wheel position** independently, with driver and passenger(s) in the vehicle as described in the *Michelin Recreational Vehicle Tire Guide* (MWL43146 Rev. 6/07) to determine the correct air pressure for the weight on each wheel position. Then use the charts in the guide and adjust the pressure accordingly when the tires are cool or have not been driven for more than one mile. You may call 1-800-847-3435 for a copy of the *Michelin Recreational Vehicle Tire Guide*.

NOTE: Never reduce the air pressure in a hot tire.

REMEMBER: For control of your RV, it is critical that the tire pressure be the same on both sides of the axle.

Brake System

Brake System

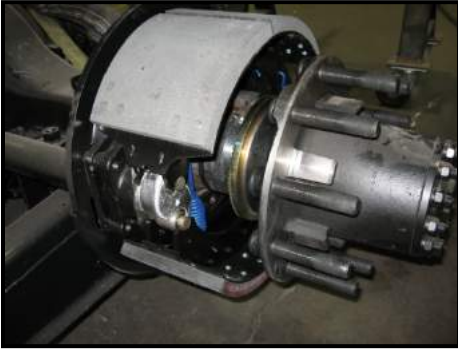

Figure 2-1: Rear Brakes

- **Front brakes are air applied drum**
 - Two large 15 x 4" drum brakes
- **Rear brakes (Figure 2-1) double as parking brake**
 - Park brakes are spring applied
 - Two large 15 x 8.625" drum brakes
 - Park brake remains applied even if air pressure is lost
- **If air pressure is lost**
 - A buzzer and warning lamp will alert you
- **Chassis is equipped with automatic slack adjusters (Figure 2-2)**
 - No brake adjustment required

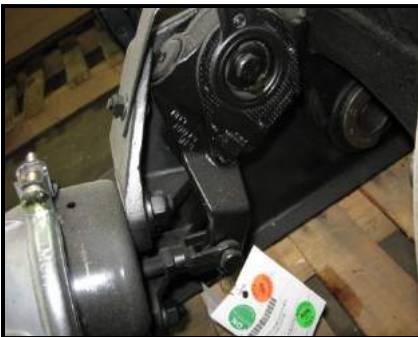

Figure 2-2: Automatic Slack Adjuster

The rear brakes on the PowerGlide chassis are also used as the parking brakes. This provides you the holding power of two large drum brakes to prevent your coach from rolling, even when fully loaded on a 20% grade.

A decrease in air pressure will **not** cause an immediate loss of brakes. If a leak develops in the air system while driving (at approximately **60 to 65 PSI**), you will be alerted via a light on the instrument panel and an audible alarm. As you apply the brakes, the air supply holding the park brakes in the released position will gradually be

depleted. When fully depleted (approximately **40 PSI to 45 PSI**), the rear brakes will set. This allows you sufficient time to pull over to the side of the road.

NOTE: The rear brakes have dual chambers – one for the service brakes and one for the park brake. The service brakes are air applied and spring released. The park brake is spring applied and air released.

The brake system is equipped with automatic slack adjusters that avoid the need to manually adjust your brakes. Each time you step on the brake pedal, if adjustment is needed, the adjusters will take up the slack.

Compressed Air System

Tank Drains



Figure 2-3: Tank Drains

The compressed air system is comprised of two air storage tanks. The primary tank stores and supplies air for the rear brakes, the secondary tank stores and supplies air for the front brakes.

When air is compressed it becomes hot. As it cools, condensed moisture forms in the system. The air system is equipped with an air dryer to remove most of this moisture. The dryer has an automatic moisture ejector that releases the trapped moisture back into the atmosphere. However, some moisture will form in the system beyond the dryer, and make its way into the storage tanks. As moisture collects in the primary and secondary tanks, it displaces the area needed for air storage, thus requiring that the tanks be drained periodically.

The air system is equipped with air tank drains conveniently located in the left rear storage compartment (Figure 2-3). There is one drain for the primary tank and one for the secondary tank. These drains should be **opened daily** for a few seconds to remove any moisture trapped in the tanks.

Air Dryer



Figure 2-4: Haldex Dryest Air Dryer

The Tiffin PowerGlide chassis air brake system features a Haldex Dryest air dryer (Figure 2-4), which removes the condensed moisture from compressed air. The air dryer is equipped with a desiccant cartridge that needs to be changed **every 36 months**. The dryer is located on the passenger side, in the forward rear box next to the A/C condenser (behind the rear axle).

Warning

Air tanks should be bled of all pressure any time you perform work on the air system.

Scheduled Maintenance

Scheduled Maintenance

SERVICE INTERVAL 1,000	(Miles x	Daily	5	10	15	20	Required Fluids, Lubricants, and Procedures
Air System:							
Air Dryer			X				Inspect for leaks and blockage of purge valve (9)
Air Intake			X				Inspect for blockage at intake screen on rear cap
Air Filter				X			Check restriction indicator - replace filter as needed (6)
Primary Air Tank Reservoir		X					Drain condensation daily
Secondary Air Tank Reservoir		X					Drain condensation daily
Brake Systems:							
ABS Sensors						X	Clean sensors & adjust into hub rings. (1)
Brake Pads, Rotors, Shoes & Drums						X	Inspect pads, shoes, rotors & drums for wear and cracks. (1)
Slack Adjusters						X	Inspect slack adjuster for proper adjustment & grease.
Brake Hoses/Whips, Front & Rear				X			Inspect for leaks, & cracking.
Cooling Systems:							
A/C Condenser Fins				X			Inspect for blockage and wash clean every 10k or as needed
Charge Air Cooler Fins				X			Inspect for blockage and wash clean every 10k or as needed
Fan & Fan Shroud				X			Inspect for blockage and cracks.
Radiator Fins/Grill				X			Inspect for blockage and wash clean every 10k or as needed
Radiator Hoses & Pipes				X			Inspect for kinks, chaffing wear and leaks.
Coolant Level		X					Check for correct level in sight glass
Coolant Leaks		X					Inspect for visual signs of coolant on the ground
Electrical Systems:							
Rear Electrical Compartment			X				Check for loose fuses and cables
Front Electrical Compartment			X				Check for loose fuses and cables
Generator Cables			X				Check for loose red & black cables connected to generator
Alternator Belt				X			Check for correct tension and wear
Batteries			X				Check for loose lugs / remove any corrosion

Scheduled Maintenance

SERVICE INTERVAL (Miles x 1,000)	Daily	5	10	15	20	Required Fluids, Lubricants, and Procedures
Engine Systems:						
Engine Drive Belt Tension			X			Inspect belt & tension.
Engine Oil Filter			X			Replace engine oil filter per engine manual (1)
Engine Oil			X			Change engine oil per engine manual (1)
Exhaust Muffler & Piping			X			Inspect for pinholes, rust and leaks.
Diesel Fuel						Always use ultra low sulfur fuel only
Fuel Tank Vent Lines					X	Inspect for "P" traps that may cause air locks and slow filling
Fuel Tank & Lines			X			Inspect for leaks around fuel inlet nipples and hoses.
Engine Coolant						Change engine coolant per engine manual
Primary Fuel Filter					X	Replace fuel filter per engine manual (8)
Secondary Fuel Filter					X	Replace fuel filter per engine manual (8)
Steering Systems:						
Drag Link			X			Inspect castle nuts for looseness & lube rod ends w/NGLI #2 grease
Steering Gear Arm			X			Inspect for looseness.
Steering Gear			X			Inspect mount bolts for looseness & hydraulic hoses for leaks.
Steering Gear Pump			X			Inspect for hydraulic hose leaks at fittings.
Steering Shaft U-Joints			X			Inspect for loose fasteners & lube bearings w/NGLI #2.
Steering Shaft Boot			X			Inspect for clearance between boot & shaft, lubricate w/ NGLI #2 grease.
Suspension & Axles:						
Coach Alignment				X		Align coach as needed (4)
Front Ride Height Adjust			X			Inspect to make sure coach is level to ground if not see a service center.
Rear Ride Height Adjust			X			Inspect to make sure coach is level to ground if not see a service center.
Ride Height Valve Linkages			X			Grease linkage grommets w/D.A. Stewart Aqualube.
Air Suspension Bags			X			Inspect for leaks at fittings and inspect bags for leaks or cracks
Front Axle Bearings		X				Check fluid level through sight window, if low, repair leaks as necessary (1)
Front Axle Tie Rods - Inspect					X	Inspect for looseness
Front Axle Tie Rods Lubricate			X			Lubricate W/NGLI # 2 grease
Front Axle King Pins			X			Lubricate W/NGLI #2 grease
Front & Rear Shocks			X			Inspect for leaks on shock tube, replace as needed
Rear Axle Lube					X	Inspect for leaks & check fluid level. Use synthetic oil only 75W90 (3)
Wheel Lug Torque			X			Re-torque all wheels nuts - Torque 450-500 lbs (2)

Scheduled Maintenance

SERVICE INTERVAL (Miles x 1,000)	Daily	5	10	15	20	Required Fluids, Lubricants, and Procedures
Suspension & Axles:						
Automatic Slack Adjusters			X			Lubricate W/NGLI #2 grease
Slack Adjuster Cam Shafts			X			Lubricate W/NGLI #2 grease
Slack Adjuster Clevis Pins			X			Inspect for wear in clevis pin and cotter pins. Replace as necessary
Transmission & Driveline:						
Drive Shaft			X			Inspect u-joints & safety strap for loose bolts & wear, lubricate w/NGLI #2 grease
Transmission Fluid						Replace fluid at 150,000 miles or 48 months whichever occurs first. (5)
Transmission Filters						Replace filters at 50,000 miles or 24 months whichever occurs first. (5) (7)

- (1) Replace / inspect at stated mileage interval or every 6 months whichever occurs first
- (2) Re-torque all wheel nuts after the first 100 miles, then every 10K miles thereafter.
- (3) Factory filled with synthetic oil. Do not mix with mineral oils.
- (4) For best tire life and handling, alignment of front axle is recommended every 15K miles.
- (5) Factory filled with TranSynd. To maintain these service intervals, fluid must not be mixed with Dexron or other fluids.
- (6) Replace filter when indicator shows 25 inches or every two years whichever occurs first.
- (7) Control Main Spin-on Filter initial change required at 10,000 miles.
- (8) Replace at stated mileage interval or every 12 months whichever occurs first.
- (9) Replace desiccant cartridge every 36 months.

Lubrication Points

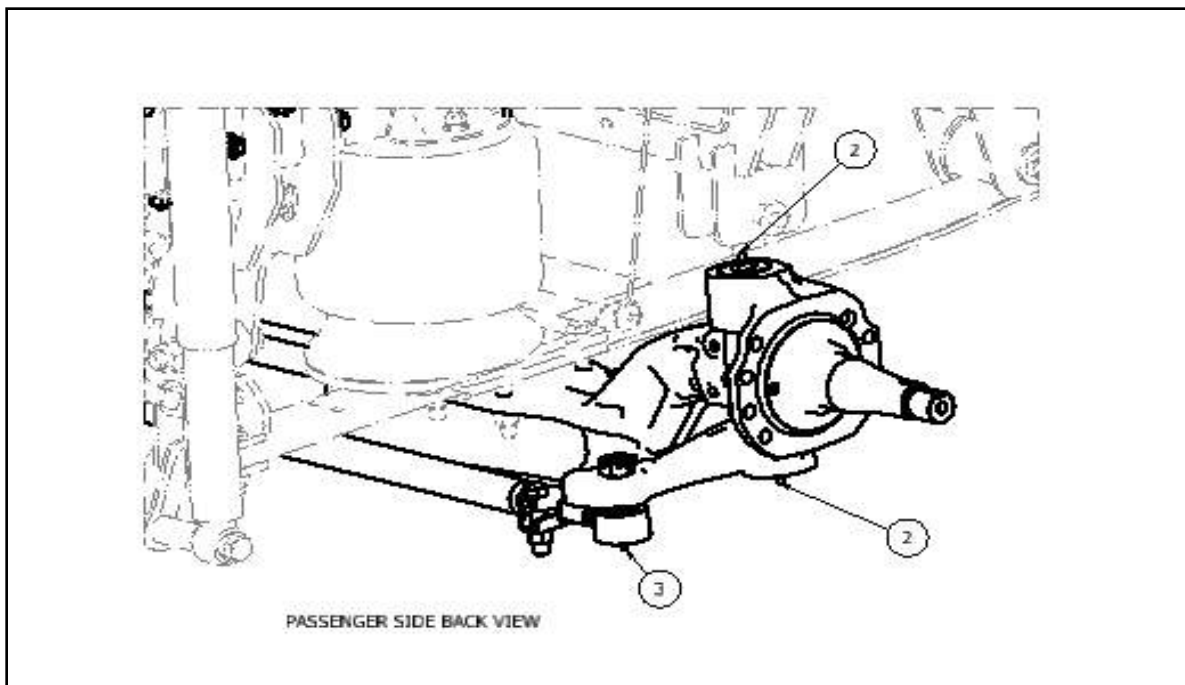
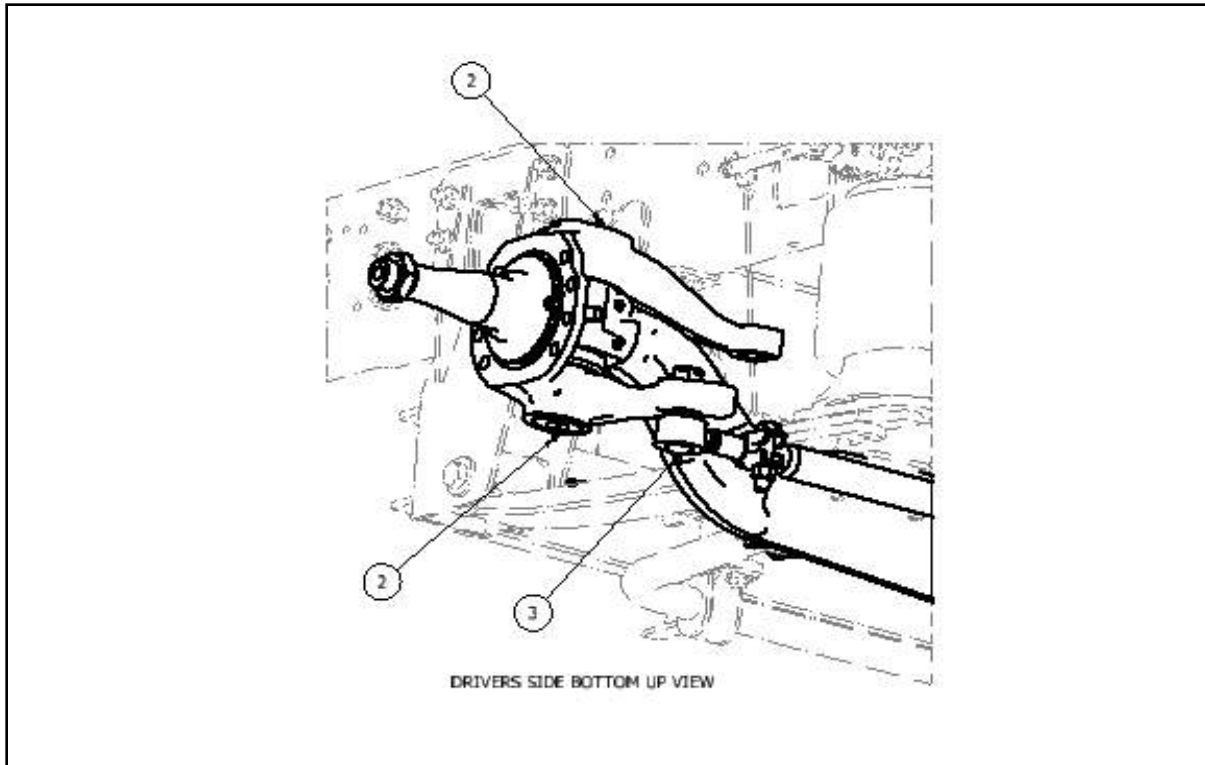

Lubrication Points

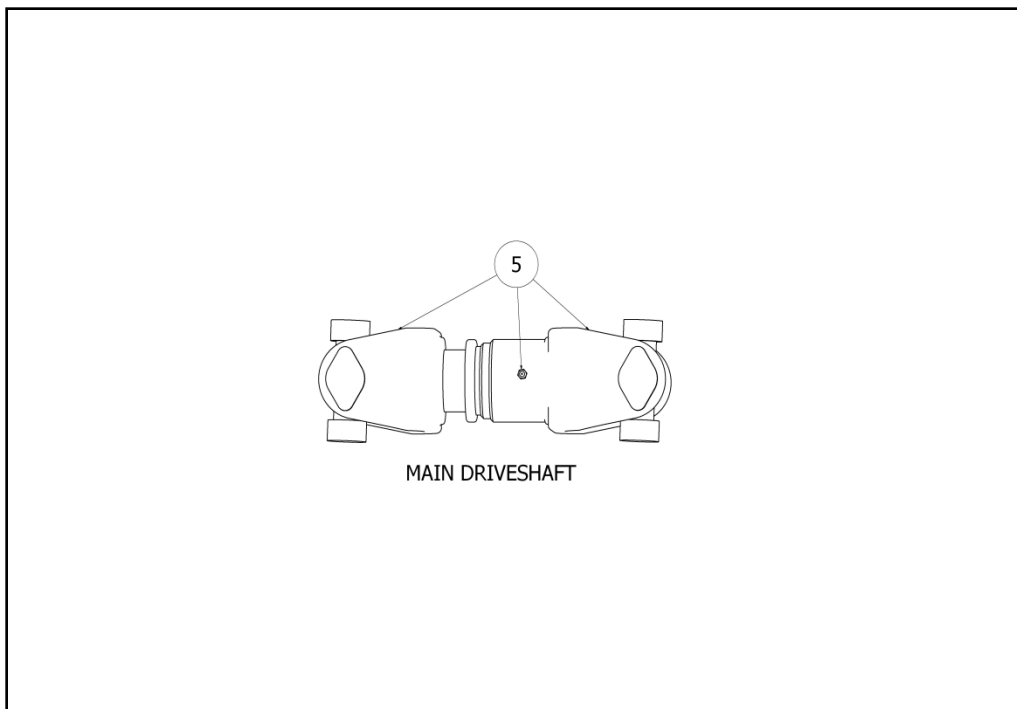
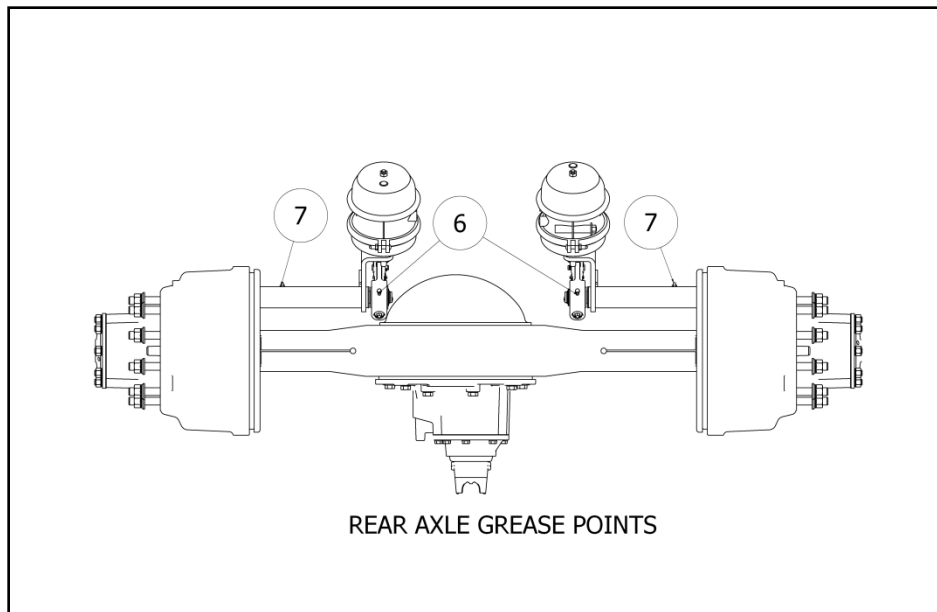

Lubrication Points

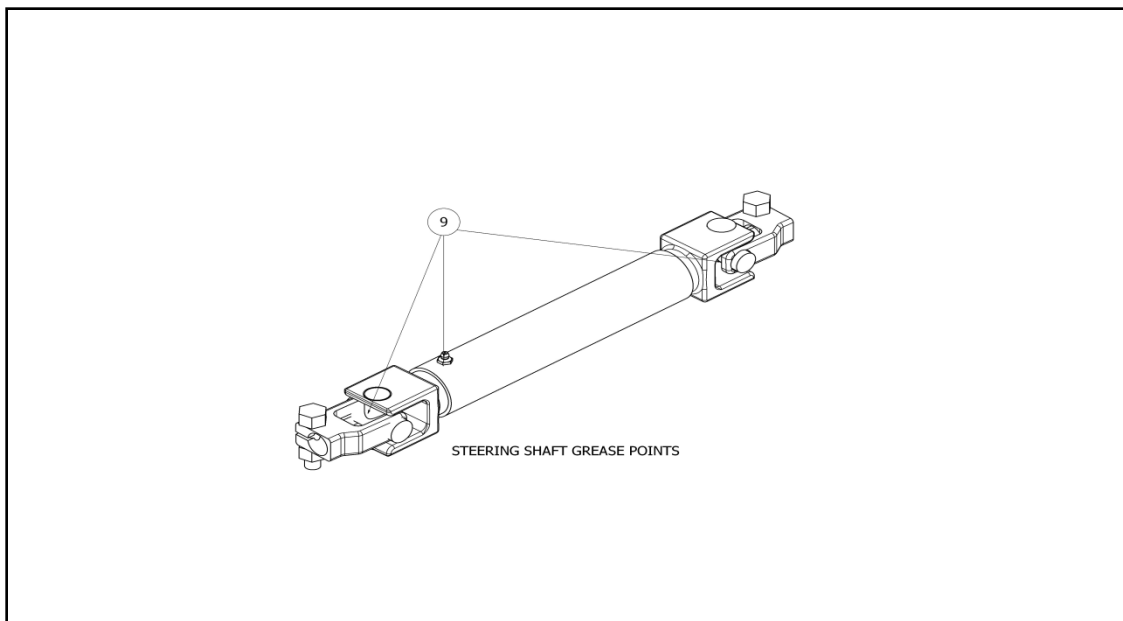
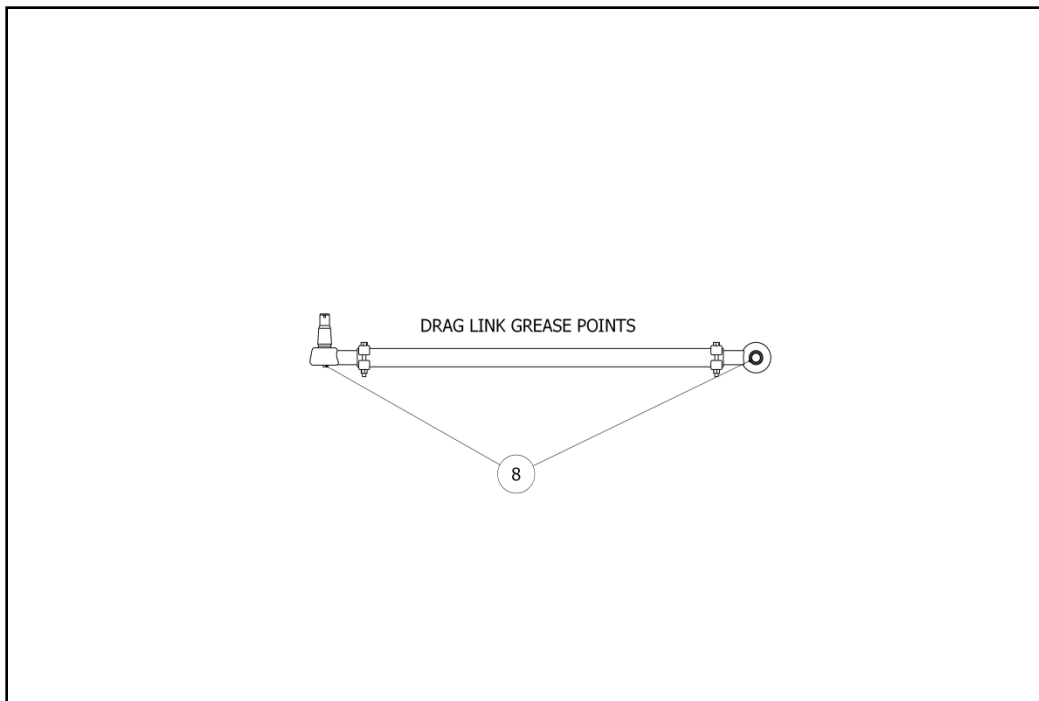

Lubrication Points

NO.	Components	Remarks	Total
2	King Pins	Two grease fittings; one on top and one on bottom of knuckle pin. Lubricate both sides of suspension.	4
3	Tie Rods	One grease fitting per tie rod.	2
5	Main Driveshaft	Three grease fittings; lubricate both universal joints & slip joint.	3
6	Automatic Slack Adjusters	One grease fitting on each slack adjuster. One adjuster on each side of the rear axle.	2
7	Rear Brake Camshaft Bracket	One grease fitting on each bracket; Pump in grease until it appears at the slack adjuster end of the bracket. Lubricate both sides of the rear axle.	2
8	Drag Link	Two grease fittings per drag link; one on each end.	2
9	Steering Shaft	Three grease fittings; lubricate both universal joints & slip joint.	3

Maintenance Parts

Fuel Filter Kit Contains Primary and Secondary Filters

Navistar part # 1876533C93 Kit Tiffin Part # 5018861

Engine Oil Filter

Navistar part # 1870752C1 Kit Tiffin Part # 5018862

Engine Air Filter

Parker / Racor # 094973004 Tiffin Part # 5011482

Transmission Filter

Allison part# 29539579 Tiffin Part # 5018863

Air Compressor Belt

Navistar part # 1847509C1 Tiffin Part # 5013853

Alternator / Fan Drive Belt

Navistar part # 1832193C2 Tiffin Part # 5013851

**For assistance with your
Tiffin PowerGlide Chassis...**

Please contact one of the following
Chassis Specialists at Tiffin Motorhomes, Inc.

256-356-8661

Plant Manager
Gary Harris, extension 2288

Service
Anson Adams, extension 2173

Parts
Bobby Luther, extension 2382

Mechanical Engineer
Brad Warner, extension 2267

Electrical Engineer
Chris Struzik, extension 2363

Please have your Chassis VIN # available
when you call.

Pre-Trip Inspection

Pre-Trip Inspection

- Check fluid levels & add as necessary
- Check tire inflation pressure
- Look for fluid leaks

Before starting your motor home daily, a few things must be checked. By doing so, you ensure that a safe trip is in order and lessen your chances of experiencing difficulties while on the road.

- Check the tires for proper inflation pressure and any damage. Also check the inner duals. Refer to the air pressure charts in this manual for proper inflation pressures.
- Look for fluid leaks under the motor home. This can prevent any serious problems from occurring later.
- Check the coolant level in the reservoir and add a 50/50 mix of coolant and water if necessary. This reservoir can be found on the rear of your vehicle.
- Check ELC (Extended Life Coolant Extender) and freeze point every 30 months or 150,000 miles. Recharge as required.

Caution

If the water temperature in your engine is greater than 120 degrees, do not remove the radiator cap! You could be severely burned.

- Approximate COOLING SYSTEM CAPACITIES – does not include the heater core or other auxiliary systems added by coach manufacturer
- Navistar Maxxforce 7 – Rear radiator 52 quarts or 13 gallons
- Check transmission fluid level
- Check engine oil level
- Check for small animals in engine compartment, such as squirrels and cats
- Check the power steering fluid reservoir

Check fuel/water separator

Maxxforce 7

- Check fuel/water separator and drain any water or contamination that may be present.

After you have completed your inspection, you may now start your engine. Turn the key to the run position and wait for the wait to start light (in some cases it may read “Inlet heater”) to turn off. You may now start the engine. ***Never use ether or any other starting fluids to start the electronic engine. The inlet heater can ignite the fumes and cause an explosion in the air inlet system.*** Once you have started the engine, monitor your gauges carefully. Make sure that the oil pressure rises within 15 seconds. If it does not, shut down the engine and call a repair facility to determine the cause.



Figure 4-1: Filter Restriction Indicator

- Check air filter restriction indicator (Figure 4-1)

Brand New Air Cleaner
10” to 12” of Vacuum

- Engine air cleaner element should be changed when the air inlet restriction indicator reaches 25 inches of vacuum **or** every two years, whichever occurs first. Reset after engine starts for true reading.

Instruments & Controls

DPS Instrument Cluster Operation

Sleep Mode

DPS is in sleep mode when battery voltage input is high, ignition key is off and wake-up inputs are not active. In this state DPS electronics are at minimum power consumption. The system exits sleep mode when one of the following wake-up inputs becomes active.

- Ignition key input
- Right and Left signal light inputs (hazard lights)

Limited mode

In limited mode the ignition key is off and the DPS offers functionality for:

- HAZARD WARNING LIGHTS
 - The right turn signal input is a wake-up input. When active the DPS will wake-up and check the status of the left signal input, and if active, will turn ON the right and left turn signal indicators.

Run mode

The DPS enters Run mode when the ignition key input is switched to high (active). This event initiates the self test routine, which takes approximately 5 seconds to complete. When the ignition input goes inactive, the DPS will drive all gauge pointers to zero except the fuel gauge.

Self Test

GAUGES

Gauge pointers sweep to full scale. The pointers will return to zero position and then to operational position.

LCD

The LCD will turn all segments on for one second, off for one second and then display the Tiffin Motorhomes logo until the start-up routine is complete

WARNING LIGHTS

The warning lights will turn on and then go to operational state at the end of the self test.

AUDIBLE ALARM

A steady alarm tone will be generated and then go to operational state at the end of the self test.

Gauges

SPEEDOMETER

The speedometer is scaled from 0 to 140 and is for both English and Metric units. The indicator of the selected units is beneath the speedometer needle. The configuration to select units can be accessed through the set-up menu or by simultaneously pressing the **MODE** and **TRIP** buttons. The factory default is English units.

Data source	Scale: Linear	WL	WL Trigger	Aud. Alarm
J1939	0 = 0 MPH/Km/h 140 = 140 MPH/Km/h	No	No	No

TACHOMETER

The Tachometer is scaled from 0 to 4 with a X1000 multiplier.

Tachometer 2.4" gauge upper left corner.

Data Source	Scale: Linear	WL	WL Trigger	Aud. Alarm
J1939	0 = 0 RPM 4 = 4000 RPM	No	No	No

FUEL

The fuel gauge is on a linear scale with E indicating empty and F indicating full. The middle of the gauge indicates 50% fuel tank level. The low fuel warning light comes on when fuel level drops to 12.5% level. The low fuel warning light turns off when the fuel level reaches 18%.













A LOW GENERATOR FUEL warning will be displayed on the LCD when the generator and ignition inputs are active and the fuel drops to 15%









Data source	Scale: Linear	WL	WL Trigger	Aud. Alarm
Fuel Sender	E = Empty ½ = 50% tank level F = Full	LCD Icon	On Fuel ≤ 15% On fuel ≤ 12.5% Off fuel ≥ 18%	4 4

AIR PRESSURE 1 / AIR PRESSURE 2

Data source	Scale: Linear	WL	WL Trigger	Aud. Alarm
Air PSI Transducer	0 = 0 PSI 150 = 150 PSI	Icon	On if press ≤ 65 PSI Off if press ≥ 72 PSI	1

Icon Lights Indicators

LED	Function	Trigger	Flash	Alarm	Color/Icon
LED1	Low Air	For both front and rear press On if pressure is ≤ 65 PSI Off if pressure is ≥ 72 PSI	Steady	1	
LED2	Low Battery	J1939 msg: if Batt V is ≤ 10.8 Volts	Steady	4	
LED3	Check Trans	Based on J1939 messages standard	Steady	4	
LED4	ABS	Based on J1939 messages standard	Steady	4	
LED6	Seat Belt	On for 30 sec when ignition sw turns on	Steady	None	
LED7	Park Brake	Park Brake Input Active Park Brake Input Inactive, Service Brake Input Inactive and current gear Neutral	Steady Quick Flash	None 2	
LED8	Failure / malfunction	ON when a priority message is active. See PRIORITY MESSAGES	Steady	None	
LED9	Stop Engine	Based on J1939 proprietary message	Steady	3	
LED10	Change Oil	Based on J1939 proprietary message	Steady	None	
LED12	Check Engine	Based on J1939 proprietary message	Steady	None	
LED13	HEST	Based on J1939 messages standard	Steady	None	
LED14	DPF	Based on J1939 messages standard	Steady Flash	None None	
LED17	Left Turn	On when left turn input is active	Steady	5	

LED18	Cruise Control	Based on J1939 messages standard	Steady	None	
LED20	Wait To Start	Based on J1939 messages standard	Steady	None	
LED21	Water in Fuel	Based on J1939 messages standard	Steady	4	
LED22	Low Fuel	On fuel $\leq 12.5\%$ Off fuel $\geq 18\%$	Steady	4	
LED23	High Beam	On when high beam input is active	Steady	None	
LED24	Right Turn	On when right turn signal is active	Steady	5	
LED25	MPH	On when English units is selected	Steady	None	
LED26	KM/H	On when metric units is selected	Steady	None	

Audible Alarms

Audible Alarm	Freq 1	T1	Period
1	900 Hz		Continuous
2	700 Hz / 750Hz	160 ms / 160ms	Continuous
3	900 Hz	160 ms	2.2 S
4	900 Hz	160 ms	Once no repeat
5	Turn Signal Click		Turn signal click

Note: Alarm 1 has the highest priority and alarm 5 the lowest. Highest alarms override any active lower alarm.

DATA COMMUNICATION

The DPS communicates with the vehicle through the J1939 network. See [appendix A](#) for a list of supported messages.

COMUNICATION ERRORS

The DPS LCD shall report “not received” parameters for Engine, Transmission and ABS if the data is not received for 2.5 seconds on the J1939 network. The LCD messages will be displayed as:

- “ENGINE COMM FAIL”
- “TRANS COMM FAIL”
- “ABS COMM FAIL”

The failure/malfunction LED will also be active for this condition.

The message(s) and LED will turn off once communication is reestablished.

SERVICE BRAKE

The service brake status will be broadcasted on the J1939 network. The service brake output is hardwired into the IP as active low input.

PARKING BRAKE

The parking brake status will be broadcasted on the J1939 network. The parking brake output is hardwired into the IP as active low input.

LCD MESSAGES

The LCD gives visual operational information and diagnostics information to the operator.

DRIVE MODE SCREEN

After key on and with no active fault messages the LCD displays odometer, time and the selected main menu items.

9999999.9 mi	12:19 PM
Trip 1 [mi]	Engine Temp [°F]
9999.9	183

LCD TIME CLOCK

The LCD will display current time on the right end side of the display. Time can be accessed and adjusted through the setup menu [Clock Adjust](#).

ODOMETER

The odometer range is 0.0 - 9,999,999.9. The resolution is 0.1 miles/kilometers. Distance value is displayed based on engine data transmitted on the J1939 network.

TRIP 1 ODOMETER

Trip 1 is operator selectable through the main menu. The reading range is 0.0 – 9,999.9 with a 0.1 miles/kilometers resolution.

TRIP 2 ODOMETER

Trip 2 is operator selectable through the main menu. The reading range is 0.0 – 9,999.9 with a 0.1 miles/kilometers resolution.

PRIORITY MESSAGES

Priority messages, when active, will replace the selected menu reading in the second LCD line. In the event that multiple messages are active each message will be displayed for 2 seconds, followed by the second warning message for 2 seconds. The failure/malfunction LED will also be active for this condition. Messages can be acknowledged by pressing the **TRIP** button; this removes the message off the screen, but the failure/malfunction LED will remain active as long as the message trigger is present.

PRIORITY MESSAGES

LCD Message	Trigger	Acknowledge	Turns off if	Alarm
Engine Comm Error	No data communication	Press TRIP	Communication is reestablished	4
Trans Comm Error	No data communication	Press TRIP	Communication is reestablished	4
ABS Comm Error	No data communication	Press TRIP	Communication is reestablished	4
Turn Signal On	Turn signal on for more than one mile	Turn signal back to off position	Turn signal back to off position	none
Oil pressure (number value)	Oil PSI exceeds normal value	Press TRIP	Message clears	4
Eng coolant temperature (number value)	Engine coolant exceeds normal value	Press TRIP	Message clears	4
Jacks Down	On when jacks down, ignition, and parking brake inputs are active Failure LED is OFF	none	Message clears	none
Jacks Down	On when jacks down and ignition are active and parking brake input is inactive	none	Message clears	2



NOTE: Jacks Down input is currently not being utilized.

Rolling Alarm

When the vehicle is in neutral and the park brake and service brake are not active, an alarm will sound to indicate a rolling hazard. An alternating 2 tone continuous alarm will sound and the brake icon will flash at a rapid rate (2Hz). This alarm can not be acknowledged.

Main Menu

Pressing the **MODE** button will access the main menu. While in the main menu, pressing **MODE** or **TRIP** buttons will scroll through the menu items. If there are no button presses for 5 seconds, the main menu will be exited and the position select window will be displayed. Pressing both buttons simultaneously will also exit the main menu and display the position select window. If a button press is not detected within 5 seconds, the position select window will be exited and the drive mode screen will be displayed. The drive mode displayed items will be unchanged if a location selection has not been made.

The following is the list of available parameters.

- Engine Temperature
- Chassis Battery
- Oil pressure
- Transmission Oil Temperature
- Check List (see [Appendix B](#) for the checklist)
- Trip 1 Distance
- Trip 2 Distance
- Instantaneous Fuel Economy
- Average Vehicle Speed
- Average Fuel Economy
- Engine Hours

9999999.9 mi	12:19 PM
Avg Fuel [MPG]	Engine Temp [°F]
0.0	183

Press MODE button



Trip 1 Distance
Trip 2 Distance
Instantaneous Fuel Economy
Average Vehicle Speed
Average Fuel Economy

Highlight item, 5 second timeout or 2 button press.



Select location...	
T	M

TRIP is pressed.



9999999.9 mi	12:19 PM
Trip 1 [mi]	Engine Temp [°F]
9999.9	183

Set-up Menu

The Set-up Menu is accessible when the ignition key is ON, and vehicle speed is less than 3.1MPH (5Km/h). Pressing and holding the **MODE** button for 5 seconds will enter the set-up menu. While in the set-up menu, pressing the **MODE** or **TRIP** buttons will scroll through the menu items. If no button is pressed for over 5 seconds the highlighted option will be selected. Pressing both buttons simultaneously will also select the highlighted option.

The following is the list of available set-up options.

- Contrast
- Restore Defaults
- Units
- Software Version
- Cluster Testing
- Clock adjust
- Exit Menu

Contrast

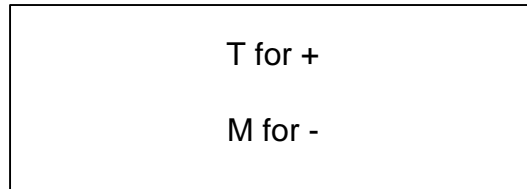

Displayed on LCD

Restore Defaults

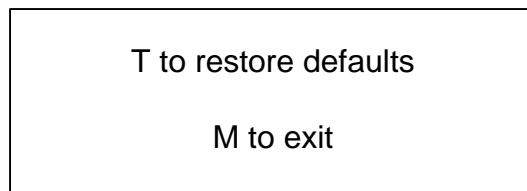

Displayed on LCD

Units

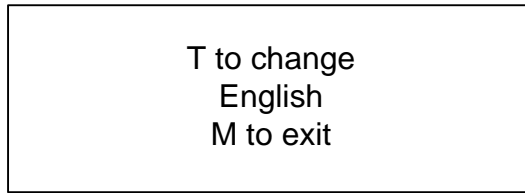

T to change
English
M to exit

Displayed on LCD

Software Version

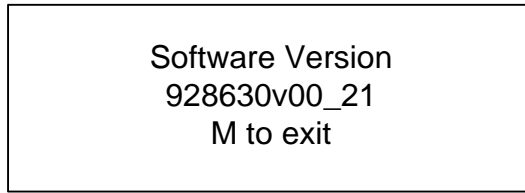

Software Version
928630v00_21
M to exit

Displayed on LCD

Cluster Testing

Gauge Test

Each gauge will be driven to the 0%, 50% and 100% position, pausing at each position for approximately 3 seconds. The LCD will display the position that the gauges should be in. Pressing the **MODE** button will exit this test and return to the Cluster Testing menu.

Warning Lights

Each icon light will be turned off at the beginning of the test. The LCD will display which icon is being tested and whether it is ON or OFF. The test will continually cycle through all of the icons until the test is exited by pressing the **MODE** button.

Graphic test

Turns on the Tiffin logo and inverts the colors every two seconds. Pressing the **MODE** button will exit this test and return to the Cluster Testing menu.

Backlight Test

All backlighting will be cycled through 0%, 50% and 100% as indicated by the LCD. Pressing the **MODE** button will exit this test and return to the Cluster Testing menu.

Speaker Test

The 4 alarm tones will be sounded for approximately 10 seconds each. The test will continually cycle until the test is exited by pressing the **MODE** button.

Digital Inputs

The digital inputs will be listed by their function and the current status of each input will be indicated by an ON or OFF. Pressing the **MODE** button will exit this test and return to the Cluster Testing menu

Analog Test

The analog inputs will be listed by their function and the current value being detected will be indicated.

Power Train Faults

All DM1 messages that are active will be displayed. The source of the fault, the SPN and FMI will be indicated. If there are no active faults, the text "No Faults" will be displayed. Pressing the **MODE** button will exit this test and return to the Cluster Testing menu

Clock Adjust

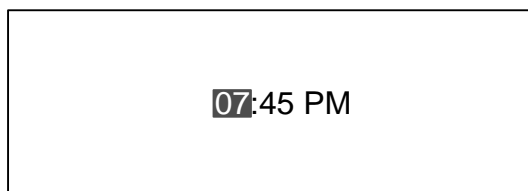

Displayed on LCD

The time will be displayed on the LCD as indicated above. Pressing the **TRIP** button will increase the highlighted value. Pressing the **MODE** button will shift from hours to minutes to AM/PM and then exit to the Set-up Menu.

Resettable Values

The operator has the ability to reset Trip1, Trip 2, Average Vehicle Speed, and Average Fuel Economy.

If only one of the resettable items is displayed on the LCD, press and hold the **TRIP** button for at least 4 seconds to highlight that item (colors will be inverted). A single press of the **TRIP** button will reset the value to 0 and exit the reset mode, or a single press of the **MODE** button will exit the reset mode, leaving the value unchanged.

61453.3mi	12:19 PM
Engine Temp 183°F	Trip 1[mi] 780.7

Single highlighted resettable item on LCD

If two resettable items are displayed, the item on the left will be highlighted. A single press of the **MODE** button will highlight the item in the right window. A second press will exit the reset mode, leaving the items unchanged. A single press of the **TRIP** button will reset the highlighted value to 0 and exit the reset mode.

61453.3mi	12:19 PM
Avg Speed [mi/hr] 43.7	Avg Fuel [MPG] 16.7

Highlighted item with two resettable items on LCD

Article I. Appendix A

DESCRIPTION 1	DESCRIPTION 2	PGN	SPN	DEFINITION	TX/RX
Electronic Brake Controller 1	EBC1	61441	N/A	Note: Monitoring message to confirm ABS comms	Rx
Electronic Engine Controller 1	EEC1	61444	190	Engine speed	Rx
Electronic Trans Controller 2	ETC2	61445	523	Transmission Current Gear	Rx
Shutdown	Shutdown	65252	1081	Wait to start	Rx
Engine Hours	Hours	65253	247	Total engine hours	Rx
Engine Temperature 1	ET1	65262	110	Engine coolant temp.	Rx
Engine Fluid Level/Pressure 1	EFL/P1	65263	100	Engine oil pressure	Rx
Cruise Control/Vehicle Speed	CCVS	65265	84	Wheel-based vehicle speed	Rx
Cruise Control/Vehicle Speed	CCVS	65265	596	Cruise Control Enable	Tx
Cruise Control/Vehicle Speed	CCVS	65265	597	Service brake switch	Tx
Cruise Control/Vehicle Speed	CCVS	65265	70	Park brake switch	Tx
Cruise Control/Vehicle Speed	CCVS	65265	599	Cruise set	Tx
Cruise Control/Vehicle Speed	CCVS	65265	601	Cruise resume	Tx
Fuel Economy	LFE	65266	184	Inst. Fuel Economy	Rx
Vehicle Elec. Power	VEP	65271	158	Battery potential (volts), sw	Rx
Water in Fuel Indicator	WFI	65279	97	Water In Fuel Indicator	Rx
Req. for Engine Hours		59904		Request for Engine hours	Tx
Custom Message1	CM1	65400	7270	Change Oil Indicator	Rx
Custom Message1	CM1	65400	7260	Check Engine Indicator	Rx
Diesel Particulate Filter Control1	DPFC1	64892	3698	Exhaust System High Temperature Lamp Command	Rx
Diesel Particulate Filter Control1	DPFC1	64892	3697	Diesel Particulate Filter Lamp Command	Rx
Custom Message1	CM1	65400	7261	Check Engine Indicator	Rx
High Resolution Vehicle Distance	VDHR	65217	917	High Resolution Total Vehicle Distance	Rx
Shutdown	SHUTDN	65252	1081	Engine Wait to Start Lamp	Rx
Fuel Consumption (Liquid)	LFC	65257	182	Engine Trip Fuel	Rx

Article II. Appendix B

Checklist

- JACKS / AIR LEVELLER UP
- CHECK TOW VEHICLE
- TIRE PRESSURE
- ENGINE MAINTENANCE
- DISCONNECT POWER
- DISCONNECT WATER
- DISCONNECT SEWER
- BAY DOORS CLOSED
- SHOWER DOOR LOCKED
- ROOF VENTS CLOSED
- AWNING ARMS LOCKED
- COUNTERTOP CLEAR
- ALL DOORS LOCKED
- DRAWERS LATCHED
- APPLIANCES SECURED
- SLIDES IN AND SECURED
- WINDOWS CLOSED
- CB RADIO ON

Article III. Appendix C



5 Gauge DPS standard overlay

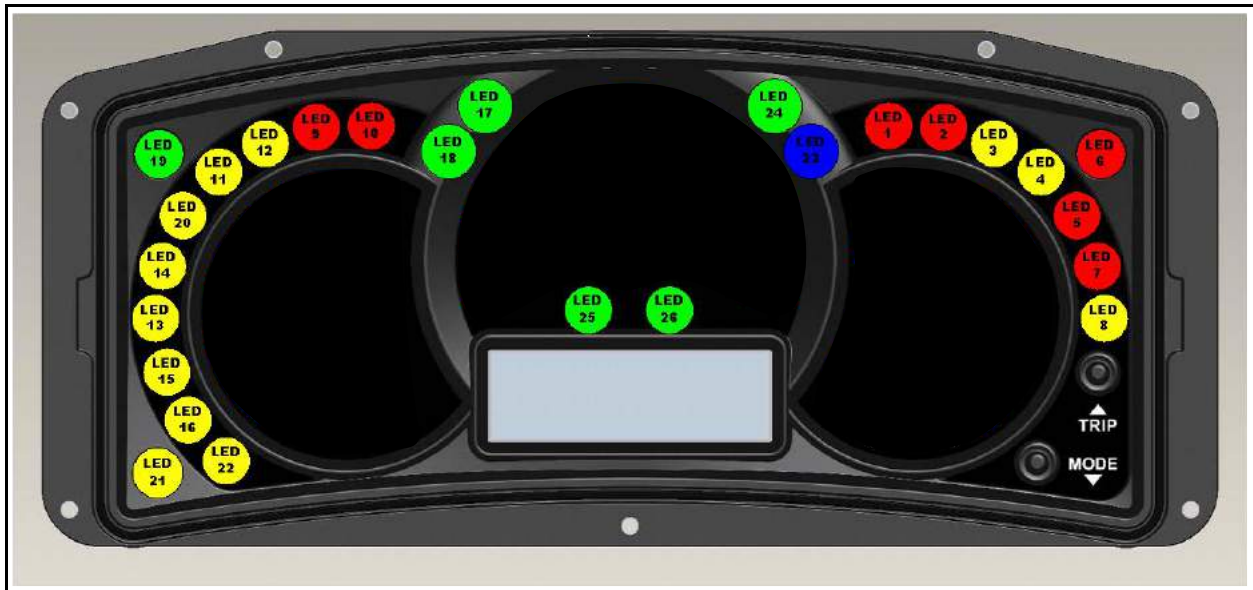

5 Gauge DPS standard tell-tale color locations

Article IV. Appendix D

Connector J1 - Mating connector shell is Molex part # 33472-2007 (Keying option B)			
Pin #	Generic Name	Function	Tiffin Function Assignment
1	DIGITAL_2	Digital Input - wakeup	Right Signal
2	DIGITAL_1	Digital Input - wakeup	Ignition
3	CAN_SHIELD_2	CAN Shield for CAN2	NOT USED
4	CANL_2	CAN Low for CAN 2	NOT USED
5	CANH_2	CAN High for CAN 2	NOT USED
6	CAN_SHIELD_1	CAN Shield for CAN1	CAN SHIELD CONNECTION
7	CANL_1	CAN Low for CAN 1	CAN HIGH CONNECTION
8	CANH_1	CAN High for CAN 1	CAN LOW CONNECTION
9	GND	Direct Ground Connection	Ground connection
10	VBATT	Direct Battery Connection	Battery connection
11	DIGITAL_3	Digital Input - wakeup	spare
12	DIGITAL_4	Digital Input - wakeup	Generator
13	DIGITAL_5	Digital Input - Low	Chassis ID1
14	DIGITAL_6	Digital Input - Low	Chassis ID2
15	GND	Sensor Ground for analog sensors	Provide GND to transducers
16	ANALOG_1	Analog	Fuel sender 28-250Ω
17	ANALOG_2	Analog	Dimmer Pot (waiting for specs) 0-12V?
18	FREQ_1	Frequency	spare
19	HSO_1	High Side Output	spare
20	LIN_BUS_1	low side output	spare

Connector J2 - Mating connector shell is Molex part # 33472-2006 (Keying option A)			
Pin #	Generic Name	Function	Tiffin Function Assignment
1	DIGITAL_17	Digital Input - Low	Cruise Enable
2	DIGITAL_16	Digital Input - Low	Cruise Set
3	DIGITAL_15	Digital Input - Low	Cruise Resume
4	DIGITAL_14	Digital Input - High	Left signal
5	DIGITAL_13	Digital Input - Low	Park Brake
6	DIGITAL_12	Digital Input - High	ALARM
7	DIGITAL_11	Digital Input - High	spare
8	DIGITAL_10	Digital Input - High	spare
9	DIGITAL_9	Digital Input - High	spare
10	DIGITAL_8	Digital Input - Low	spare
11	ANALOG_3	Analog	spare
12	ANALOG_4	Analog	AIR 2
13	FREQ_2	Frequency or Digital Input	spare
14	LSO_1	Low Side Output	spare
15	HSO_2	Analog (Analog_6)	AIR 1
16	DIGITAL_18	Digital Input - Low	service brake
17	DIGITAL_19	Digital Input - High	High Beam
18	DIGITAL_20	Digital Input - Low	Jacks Down
19	DIGITAL_7	Digital Input - Low	spare
20	5V_OUT	5V sensor reference	Will be used to supply pwr to transducers

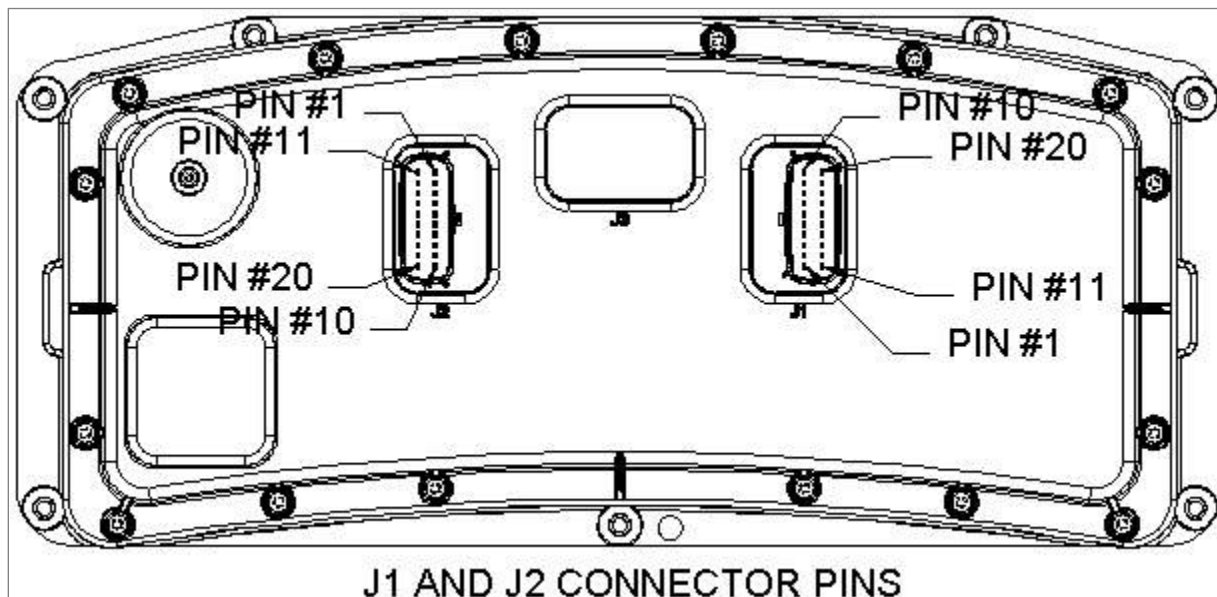

Warranty

Warranty

- **Engine**
 - Navistar Maxxforce 7, 5 years or 100,000 miles

- **Transmission**
 - Allison 1000/2100 MH Series: 5 Years or 200,000 miles

- **Chassis**
 - 3 Years or 50,000 miles

- **Drive Train**
 - 3 Years or 50,000 miles

- **Suspension**
 - 3 Years or 50,000 miles

Allegro Owner's Club

Allegro Owner's Club



The Allegro Owner's Club is an organization for Allegro motor home owners that provide access to rallies and more. Several rallies are organized throughout the year. The rallies are normally a package deal which includes your campground fees, entertainment, several meals, transportation to and from planned activities, suppliers exhibits, plenty of door prizes, and much more. Service technicians from Tiffin Motorhomes, Inc. are also available to do minor repairs to rally participants motor homes as well as sales representatives who can answer questions about your motor home and other issues. Of course, free time is scheduled into each rally for your personal leisure and interests.

If you purchase a new unit, Tiffin Motorhomes pays for your first year of membership. Club members are also eligible to purchase insurances at discounted rates as well as other companies that provide discounts to our Club members.

Local chapters are also set up throughout the country. These local chapters generally have monthly campouts which allow you to meet new friends and share information.

The Allegro Club also publishes a quarterly newsletter, *Side Roads*, which keeps members informed about rallies, caravans, chapter news, safety information, factory news, and much more. *Side Roads* is published in March, June, September, and December.

Allegro Club merchandise is also available at the Allegro Store in Red Bay, AL. You can purchase shirts, caps, jackets, and other accessories emblazoned with the Tiffin name brands.

For more information on the Allegro Club or to join, please contact membership coordination at 256-356-8522 or visit our web site: www.tiffinmotorhomes.com.

Suggestions

Send Us Your Suggestions

Please send us your suggestions on what you would like to see covered in this publication. These should be operation or maintenance items. When you have completed your suggestions, mail them to Tiffin Motorhomes, 105 2nd Street NW, Red Bay, AL 35582. Attention: Gary Harris.

Please Print:
