



TIFFIN

MOTORHOMES

2024 Owner's Manual



ZEPHYR



TIFFIN

MOTOR HOMES

DISCLAIMER

Many of the features and appliances described in this manual might not be reflected in the actual motor home purchased, depending on the options and models selected by the motor home owner. All items, materials, instructions, and guidance described in this manual are as accurate as possible at the time of printing. However, due to Tiffin Motor homes' ongoing and dedicated commitment to excellence, improvement of Tiffin's motor homes is a continuing process. Consequently, Tiffin Motor homes reserves the right to make substitutions and improvements in its makes and models of motor homes without prior notification. Substitutions of comparable or better materials, finishes, appliances, instrumentation, and instruction might be made at any time it is deemed prudent to provide the customer with the best possible motor home, meeting the customer's requirements.

Copyright © by Tiffin Motor homes, Inc. - all rights reserved

Tiffin Motor homes, Inc.

105 2nd St. NW

Red Bay, AL 35582

Phone: 256-356-8661

Fax: 256-356-8219

Email: customersupport@tiffinmotorhomes.com

www.tiffinmotorhomes.com



TIFFIN

Many Adventures. One Dream.™



There are many ways to adventure in our products, but all customers share a similar dream of leisure, exploration, and fun while making lifelong memories with the most important people in their lives.

Our products are the vehicle for customer's adventures and helping them realize their dreams.

TABLE OF CONTENTS

1 General Information	1
Welcome to a life of “roughing it smoothly”	2
About This Manual	2
Delivery	3
Dealer Responsibilities	3
Customer Responsibilities	3
Reporting Safety Defects	4
Tiffin Motor homes Limited Warranty	5
Major Equipment Manufacturers	5
Warranty Service	6
Owner’s Information Package	6
Customer Relations	6
Specification Labels	6
Weighing Procedures	9
Weight Distribution	9
Safety Messages	10
2 Safety Instructions	11
Safety Considerations	12
General Warnings	12
Pre-Departure Checklist	13
Driving Safety	14
Fuels for the Motor home	15
Carbon Monoxide Warning	15
CO/LP Gas Detector	16
Fire Safety	18
Fire Extinguisher	18
Smoke Detector	19
Electrical	19
Loading	19
Maintenance	20
Parking Procedures	20
Towing Hitch	20
3 Heating & Air Conditioning	22
Aqua-Hot Heating System	23
Air Conditioning System	24
Air Conditioning Controls	25
Thermostat On Spyder Controls System	26
Heat Pump Controls	27
4 Major Appliances	28
Residential Refrigerator	29
Microwave/Convection Range	29
Air Filtration Fan	30

TABLE OF CONTENTS

CookTop.....	31
Dishwasher	33
Stacked Washer/Dryer	34
5 Entertainment	35
Television Antenna.....	36
Television Satellite Dish.....	36
Television Sets	37
Television Lift	38
Optional TV Lift in Living Room	38
TV in Bedroom	38
Infrared Repeater	39
Surround System	39
Blu-ray Player	39
6 Cabinets & Furniture	40
Cabinets.....	41
Furniture	43
Kitchen, Living & Dining Areas	43
Bedroom Area	44
Rear Egress Door (Optional).....	45
Power Smart Bed (Optional).....	46
7 Structural Features.....	47
Chassis Features	48
8 Electrical Features	49
General Information.....	50
Electrical Cautions	51
Circuit Breaker Boxes	51
Auxiliary Start Switch	52
Battery Inspection and Care	53
House Battery Disconnect Panel	55
Engine Battery Disconnect Panel.....	55
KING EXTENDED BOOSTER (OPTIONAL)	56
12 Volt DC (VDC) Receptacles	56
USB Receptacles.....	56
Inverter	57
120 Volt (VAC) AC Receptacles	58
Ground-Fault-Circuit-Interrupt Receptacles	59
Electrical Generator	60
Energy Management System.....	61
Electrical Power Cord Reel	61
Automatic Transfer Switch	61
Fuse Blocks	62
Seven-Pin Towing Connector	63

TABLE OF CONTENTS

WIFI ANTENNA (OPTIONAL)	64
Electrical Diagram	65
45FZ.....	65
9 Slide-Out Features	71
Slide-Out Overview	72
General Considerations	72
Operating Precautions.....	73
Extending the Slide-Out Room	74
Retracting the Slide-Out Room	74
Emergency Slide-Out Room Control Override	76
10 Exterior Features	77
Towing Hitch	78
Exterior Sides	78
External Solar Port	78
Electric Slide Tray	79
Security Lights	80
Roof.....	80
Electric Steps	80
Mirrors.....	83
11 Interior Features	85
Bedsread.....	86
Flooring	86
Heated Tile Floor	87
Ceiling	87
Ceiling Fan	87
Window Treatments.....	88
Multiplex Lighting Control	88
Safe	89
Rear Fireplace	89
12 Plumbing & Bath Features	90
Tank-Level Monitor	91
Kitchen Sink And Instant Hot Water	91
Bathroom Sink, Shower, & Accessories	92
Water Pump	92
City Water Connection.....	93
Filling the Freshwater Tank	94
Water Filter	94
Freshwater Lines	95
Sanitizing	95
Wastewater General Information	96
Toilet.....	96
Black-Water Holding Tank.....	98

TABLE OF CONTENTS

Gray-Water Holding Tank	98
P-Traps.....	98
Wastewater Disposal.....	99
Sewer Connection and Camping	99
No Fuss Flush	100
Exterior Shower.....	100
Aqua-Hot Heating System	101
Plumbing diagram.....	103
45FZ.....	103
13 Windows, Awnings, Vents, & Doors	107
Windows.....	108
Awnings	108
Vents.....	110
Doors.....	110
Keyless Lock	111
14 Driving Your Motor home	112
Instrument Panel	113
Levelling The Zephyr: Instrument Panel.	113
Camera Monitor System	113
Secondary Passenger Monitor	114
CB Radio System Antenna Connection	114
Xcite Radio System	115
Dashboard Heating/Cooling Controls	115
Mobileye Collision Mitigation System (Optional)	115
On Guard Adaptive Cruise Control	115
15 Routine Maintenance.....	116
Washing	117
Seals	118
Proper Sealants for Application	119
Road Salt and Other Road Treatments	119
Wheel Care.....	119
Roof Care & Maintenance	120
Moisture Management.....	120
Interior Care of Your RV	121
Control Relative Humidity	121
Avoid Drastic Thermostat Setbacks	121
Manage Window Condensation	121
Carpet Care and Moisture Management	122
Cleaning Tile and Wood Floors.....	122
Storage and Other Isolated Areas within the RV.....	122
Use of Un-Vented Combustion Equipment.....	122
Exterior Care of Your RV	122

TABLE OF CONTENTS

Use of Your RV	123
Severe Environments.....	123
Storage of Your RV	123
Modifications to your RV	123
Wet Areas	124
Tire & Safety Information.....	124
Section One	124
Section Two.....	132
Section Three	132
Tire Pressure	135
Interior Care	139
Fabrics	141
Walls & Ceiling	142
Dashboard.....	142
Woodwork & Floors	142
Countertops	143
Accessories	143
Detectors	144
Condensation.....	144
Routine Maintenance Schedules.....	145
Winterizing.....	146
De-Winterizing.....	148
16 Maintenance & Data Charts	150
RV Owner Data Sheet.....	151
RV Owner Maintenance Record	152

ZEPHYR

GENERAL INFORMATION

Chapter

1

ZEPHYR

WELCOME TO A LIFE OF “ROUGHING IT SMOOTHLY”



Tiffin Motor homes – Made To Move You

Tiffin Motor homes is excited that you have entered the world of motor home travel and we believe that you and your family will enjoy this way of life for years to come. Your Tiffin-built motor home provides all the luxuries and comforts of home while allowing you to travel freely as you choose.



But, before heading out on the open roads, make yourself familiar with this owner’s manual to learn more about the operations of your motor home. Also, work with your dealer to learn as much as possible about the functionality and features of your coach.

And remember, *“wherever you go, we go.”*

ABOUT THIS MANUAL

Carefully read through this manual to understand how everything in your motor home works.

NOTE: This operator’s manual describes the features of your motor home and includes instructions for their safe use. The manual, however, including its photography and illustrations, is of a general nature. Some equipment and features described in this manual might be optional or unavailable on your model.

The instructions included are meant to serve as a guide and in no way extend the responsibilities of Tiffin Motor homes beyond the standard written warranty. The descriptions, illustrations, and specifications in this manual were correct at the time of printing and Tiffin Motor homes reserves the right to change specifications or design without notice, and without incurring the obligation to install the same on products previously manufactured.

Many of the instruction sheets and manuals for the various appliances inside your motor home have been incorporated into this manual for your convenience.

GENERAL INFORMATION



TIFFIN

MOTORHOMES

DELIVERY

Throughout the entire manufacturing process, your Tiffin motor home has been regularly inspected by our qualified personnel to ensure that you receive the finest product of the highest quality. However, the final inspection at our factory is not the last one. The pre-delivery inspection and system check that your dealer performs are the final inspections before you receive your new motor home. Your dealer is also available to assist you in understanding the warranties and completing the necessary forms to activate the warranties for the various appliances and accessories installed in your motor home.

DEALER RESPONSIBILITIES

A **pre-delivery inspection and systems check** is performed to ensure a thorough inspection of the motor home and the proper operation of all factory-installed components.

A **customer walk-through** is performed to familiarize the buyer with the motor home, its systems and components, and their proper and safe operation.

Delivery of the **Owner's Information Package**, which contains warranty cards and registrations for the vehicle and all factory-installed components from other vendors and suppliers to Tiffin Motor homes. The detailed operation and maintenance instructions on these components are also included in this package.

Assisting the customer in **completing the registration forms** to avoid loss of warranty coverage. The dealer will review the limited-warranty provisions with the customer to stress the importance of completing the warranty cards and registration forms for the components in the motor home to enable the manufacturers to receive them within the prescribed time limits.

Providing the customer with **information regarding warranty and non-warranty work** on the vehicle and its separately warranted components.

CUSTOMER RESPONSIBILITIES

The customer is responsible for regular and proper maintenance of the motor home. Properly maintaining your motor home will prevent conditions arising from neglect that are not covered by your Tiffin Motor homes limited warranty. The maintenance guidelines in this manual and any other applicable manuals should be followed. It is your responsibility and obligation to return the vehicle to an authorized dealer for repairs and service.

GENERAL INFORMATION

To assist you in avoiding problems with your motor home, Tiffin Motor homes recommends that you do the following:

Read the warranty. Go over it thoroughly with your dealer to make sure you understand all the terms and conditions of the warranty.

Inspect the motor home; do not accept delivery until you have gone through the motor home with the authorized Tiffin Motor homes dealer.

Ask questions about anything you do not fully understand about your motor home. Tiffin Motor homes is here to serve you and ensure that you have all the information necessary for the safe and enjoyable use of your new motor home.

When you are taking delivery, **set an appointment for adjustments.** This appointment must be within two weeks after you accept delivery.

You are responsible for, and expected, to **use your motor home in a responsible, safe manner.** Take the time to familiarize yourself with the proper operation of the unit before you attempt to use it.

REPORTING SAFETY DEFECTS

575.6(a)(2)(i) At the time a motor vehicle manufactured on or after September 1, 1990 is delivered to the first purchaser for purposes other than resale, the manufacturer shall provide to the purchaser, in writing in the English language and not less than 10 point type, the following statement in the owner's manual, or, if there is no owner's manuals, on a one-page document:

If you believe that your vehicle has a defect which could cause a crash or could cause injury or death, you should immediately inform the National Highway Traffic Safety Administration (NHTSA) in addition to notifying TIFFIN MOTOR HOMES.

If NHTSA receives similar complaints, it may open an investigation, and if it finds that a safety defect exists in a group of vehicles, it may order a recall and remedy campaign. However, NHTSA cannot become involved in individual problems between you, your dealer, or Tiffin Motor homes.

To contact NHTSA, you may either call the Vehicle Safety Hotline toll-free at 1-888-327-4236 (TTY: 1-800-424-9153); go to <http://www.safercar.gov>; or write to: Administrator, NHTSA, 1200 New Jersey Avenue, S.E., Washington, DC 20590. You can also obtain other information about motor vehicle safety from <http://www.safercar.gov>.

(ii) The manufacturer shall specify in the table of contents of the owner's manual the location of the statement in 575.6(a)(2)(i). The heading in the table of contents shall state "Reporting Safety Defects."

GENERAL INFORMATION

TIFFIN MOTOR HOMES LIMITED WARRANTY

The Tiffin Motor homes limited warranty is provided to you by your authorized Tiffin Motor homes dealer during the pre-delivery inspection. When you enquire about your Tiffin Motor homes warranty, refer to this document. If you require an additional copy of the warranty or other information, contact:

Tiffin Motor homes, Inc.
105 2nd St. NW • Red Bay, AL 35582
Phone: 256-356-8661
Email: info@tiffinmotorhomes.com

Visit www.tiffinmotorhomes.com for access to related materials.

MAJOR EQUIPMENT MANUFACTURERS

The following list is a compilation of the vendors and suppliers of the major subsystems and components of your motor home. This list is provided for your convenience and is not a substitution of the literature accompanying the "how to contact us" information supplied by the vendors and suppliers in your Owner's Information Package. Where appropriate, website information is also provided.

• Atwood Mobile Products	(800) 646-8557	atwoodmobile.com
• Aqua-Hot	(800) 685-4298	aquahot.com
• Denso Corporation	(248) 350-7500	globaldenso.com
• LG	(800) 243-0000	Lg.com
• HWH Corporation	(800) 321-3494	hwhcorp.com
• Kwikiee	(541) 942-3888	kwikee.com
• Norcold, Inc.	(800) 543-1219	norcold.com
• Onan Corporation	(612) 574-5944	onanindiana.com
• Power Gear	(800) 334-4712	powergear.com
• RV Products (Coleman A/C)	(316) 832-3400	airxcel.com
• Precision Circuits Inc.	(630) 240-9832	precisioncircuitsinc.com
• Saf-T-Alert (CO/LP Alarm)	(800) 383-0269	safetalert.com
• Sharp Corporation	(800) 237-4277	sharp-usa.com
• Suburban Manufacturing Co.	(423) 775-2131	suburbanmanufacturing.com
• The Dometic Corporation	(219) 294-2017	dometic.com
• Whirlpool	(866) 698-2538	whirlpool.com
• Winegard	(800) 788-4417	winegard.com
• Valid Manufacturing Ltd.	(888) 632-6477	validmanufacturing.com

GENERAL INFORMATION

WARRANTY SERVICE

All warranty service needs to be completed during the warranty period (basic warranty: 12 months or 12,000 miles). Tiffin Motor homes warrants its unitized construction for 10 years and its laminations for five years. Any service work performed after the expiration of the Tiffin Motor homes warranties **WILL NOT** be covered by those warranties.

Exceptions may be made, on an individual basis, to this deadline, because of the unavailability of parts and/or service appointment time where work is to be performed. However, do not rely on the possibility of an exception; schedule any desired in-warranty work before your warranty expires.

OWNER'S INFORMATION PACKAGE

The Owner's Information Package includes valuable documents about your motor home and its components and systems. By consulting the booklets and instruction manuals included in the Owner's Information Package, you will learn how to operate, maintain, and troubleshoot these items safely and effectively. The Tiffin Motor homes Owner's Manual does not cover every possible detail of equipment—standard and/or optional—installed on or in your vehicle.

As with all valuable documentation, keep them in a safe, secure place for your later use and consultation. When you complete and mail to the respective manufacturers any warranty/guaranty registration cards, make a photocopy of both sides of each card prior to mailing, and keep the photocopy in your permanent records for your motor home.

CUSTOMER RELATIONS

To schedule maintenance or service, or order parts, notify your local authorized Tiffin Motor homes dealership to set up an appointment. If you are unsure of the location of your nearest authorized Tiffin Motor homes dealership, access the Tiffin Motor homes website at www.tiffinmotorhomes.com, and then click on the "Locate Dealer" button, and then enter the appropriate search criteria, such as state and retail sales, and then click on the red ball located on the map to find dealer information in that area.

SPECIFICATION LABELS

There are two main numbers used to identify your motor home. The Vehicle Identification Number (VIN) is the legal identification of the vehicle. The VIN is the number used by the state for vehicle identification and registration. Additionally, there is a Tiffin serial number (Figure 1-1). This number can be found on the side of the dashboard. A typical sample of this identification label is shown below.

GENERAL INFORMATION



Figure 1-1: Tiffin Serial Number



Figure 1-2: RVIA Label located on the outside of the motor home

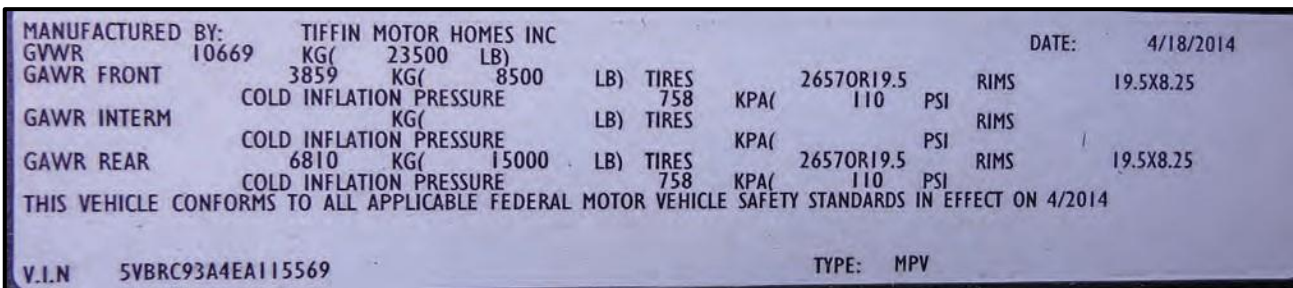

Figure 1-3: Federal Motor Vehicle Standards label located inside the doorway of the coach

Another label affixed to your motor home is the Recreational Vehicle Industrial Association (RVIA) Weight Label (Figure 1-2), which is a required label for your vehicle. Tiffin Motor homes, a manufacturer-member of RVIA, has the obligation to disclose the following information to the purchaser of the motor home:

GENERAL INFORMATION

- An indication of the contents of the motor home weight label affixed to the motor home.
- A concise explanation of the following items' vehicle Weight (VW) distribution and proper weighing techniques to be used to weigh the vehicle.

Specific definitions for the following terminology:

Gross Vehicle-Weight Rating (GVWR) –

This is the maximum permissible weight of the motor home when it is fully loaded.

Unloaded Vehicle Weight (UVW) – This is the weight of the motor home, as built at the factory, with full fuel, engine oil, and coolants. The UVW does not include cargo, fresh water, LP gas, or any dealer-installed accessories.

Occupant Cargo-Carrying Capacity (OCCC) –

This is the capacity of the motor home minus the UVW and full propane weight.

Gross Combination-Weight Rating (GCWR) –

This is the value specified by the chassis manufacturer as the maximum allowable loaded weight of the motor home with a towed trailer and/or vehicle (if any).

Sleeping-Capacity Weight Rating (SCWR) – This is the maximum weight capacity of the combined number of persons (i.e., number of people multiplied by 154 pounds per person) permitted to sleep within the vehicle.

Gross Axle-Weight Rating (GAWR) – This is the maximum allowable weight for an axle; the GAWR considers the weakest link in the tire, wheel, brakes, hubs, axle, springs, and attaching parts. To illustrate, if the axle is rated at 15,000 pounds and the tires are rated at 3,200 pounds each as a dual installation, then the maximum GAWR will be 12,800 pounds for a four-tire vehicle.

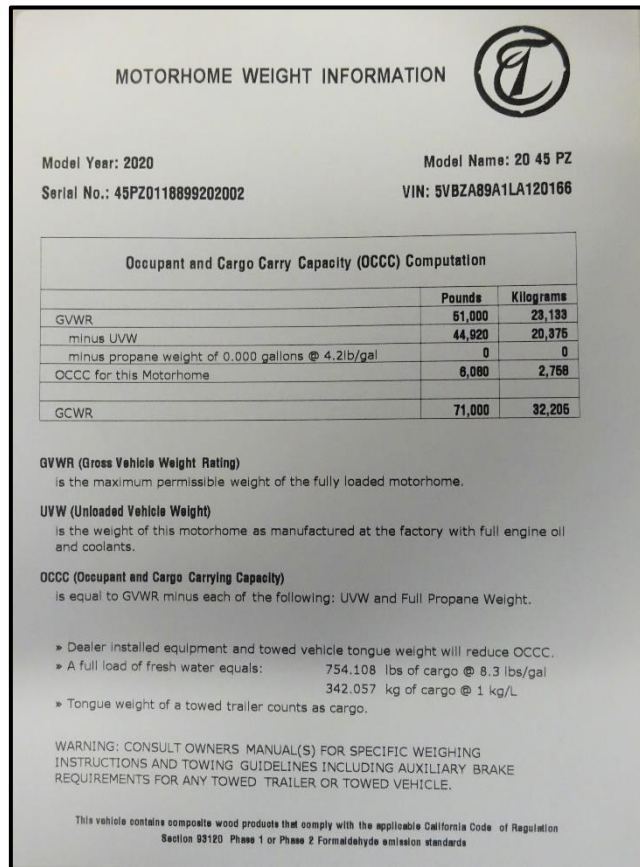

Figure 1-4: Sample Motor home Weight Label (found in the bedroom closet)

GENERAL INFORMATION

WEIGHING PROCEDURES

To weigh the motor home properly, the motor home must be level when the weighing process is performed. Your motor home has been designed and built in compliance with the recommended limits of the major-component/system suppliers to provide a realistic OCCC. It is up to the final user to provide even distribution to prevent uneven loading. Once the vehicle is loaded, it can be taken to any certified drive-on scales or individual-wheel scales to determine that the final weight is within specified limits for the motor home.

To Determine the Final Weight of the Motor home:

Drive the motor home onto the scales so that all wheels are on the scales; this provides the gross vehicle weight (GVW) of the vehicle and can be recorded as such. The GVW should not exceed the GVWR specified for the vehicle.

Drive the motor home so that the front wheels are off the scales and only the rear wheels remain on the scales; this provides the total weight of the vehicle, save for the front axle. This weight should not exceed the total rating of the axles remaining on the scales. The front axle weight is determined by subtracting the weight from the GVW that was obtained in the first step. The result should not exceed the listed front-axle weight rating.

WEIGHT DISTRIBUTION

To ensure the maximum stability of the motor home under static (i.e., parked) and dynamic (i.e., moving) conditions, the distribution of the items to be carried and stored within the motor home and in the storage bays underneath the motor home should be performed in such a manner as to strive for reasonably even side-to-side and front-to-rear dispersion of the weight of the stored items. This process will ensure that the motor home is not “lop-sided” in weight distribution (i.e., all the stored weight is not on one side and/or mainly toward the front or the rear). Keeping a center of mass of the motor home essentially centered on a front-to-rear and side-to-side basis will provide better control of the motor home when it is in motion.

GENERAL INFORMATION

SAFETY MESSAGES

Note that several labels listed in this manual represent items that need your attention. The Danger, Warning, Caution, and Notice labels alert you to precautions that might help you to avoid damage to your motor home, its equipment, or your personal safety. Read and follow them carefully.



CAUTION

CAUTION indicates a hazardous situation, which, if not avoided, could result in minor or moderate personal injury, or damage to the equipment.

NOTICE

NOTICE is used to address practices not related to personal injury, or damage to the equipment.



DANGER

DANGER indicates a hazardous situation, which, if not avoided, will result in death or serious personal injury, and damage to the equipment.



WARNING

WARNING indicates a hazardous situation, which, if not avoided, could result in death or serious personal injury, or damage to the equipment.

ZEPHYR

SAFETY INSTRUCTIONS

Chapter

2

SAFETY

SAFETY CONSIDERATIONS

Before using your motor home, especially for the first time or after a long period of non-use, read all the instructions in the Owner's Manual and the chassis-manufacturer's manual thoroughly. There are several safety considerations that you must be aware of and follow while your motor home is in motion. These safety considerations, as well as others meant to preclude any damage to the motor home, are listed in this chapter. Besides the driver, it would be helpful for the passengers to be familiar with these safety considerations and precautions too.



GENERAL WARNINGS

In general, there are several "common-sense" safety precautions that should be taken every time the motor home is to be used on the road. These precautions include:

- Only seats with seat belts should be used while the motor home is in motion; the seat belts should be worn by all people (driver, passengers) in the motor home at that time.
- While the motor home is moving, lock all seats in the forward-facing position to provide maximum safety for the users.
- While the motor home is moving, no one (e.g., young children) inside should ever stand or kneel on the seats.
- In the majority of states, it is the law that seat belts must be used (fastened snugly about the chest and hip areas), anytime the motor home is in motion, to provide desired protection in the event of a crash.
- Any fire extinguishers should be inspected on a monthly basis to ensure that each extinguisher is properly charged and ready for operation.
- Any smoke and/or carbon monoxide (CO)/liquid propane (LP) alarms should be regularly inspected and tested. If being used for the first time, the smoke and/or CO/LP alarm should be properly activated and fresh batteries installed before the motor home is placed into service. Never sleep in a motor home not having functional smoke and/or CO/LP alarms.
- While the motor home is moving, the sleeping facilities are not to be used.
- Be sure to be familiar with all emergency exits (doors, emergency window). Do not use the emergency window as a routine exit; this is strictly to be used for emergency purposes only.
- Movement inside the motor home should be minimized while the motor home is in motion.

SAFETY

- Never leave the driver's seat unattended while the motor home is in motion.

PRE-DEPARTURE CHECKLIST

For your continued safety and convenience, the following is a representative "checklist" designed to ensure your safety while driving:

- ✓ Clean all windows, mirrors, and light lenses (front, back, and sides) to ensure that you can "see" and "be seen." Reposition any mirrors or other fixtures to provide an unobstructed view (front, sides, and back) from the driver's seat.
- ✓ Remove or secure all loose fixtures (e.g., awnings, flags, antennas, portable lights) to keep them from falling from the motor home when the vehicle is in motion.
- ✓ Make a "walk-around" visual inspection of the motor home to note any irregularities (e.g., loose trim) or problems (e.g., low tires); correct noted problems accordingly.
- ✓ Check all exterior storage-compartment and generator-compartment doors to make sure they are properly latched. If need be, check inside all exterior compartments to make sure that all cargo and equipment are properly secured so they do not work loose and become hazards during sudden starts and stops.
- ✓ Check the tires for proper inflation (i.e., cold-inflation pressure: 100 psig). If the motor home has not been used, make sure that the "cold-inflation" pressure is maintained. If the motor home has recently been used, make sure that the "hot inflation" pressure (see the tire-manufacturer's literature to determine appropriate "hot inflation" pressure) is maintained. All tire pressures should be within 1-2 pounds (psi) of each other.
- ✓ Examine wheel lug nuts to ensure their proper tightness. If any lug nuts are found to be loose, first check the fit of the wheel to the hub to make sure the wheel is mounted properly, which would produce a "wobbly" wheel when the motor home is in motion, and then tighten the lug nuts.
- ✓ Check all fluid levels (e.g., engine oil, transmission fluid, coolant, power-steering fluid, brake fluid, battery fluid [if applicable], windshield-washer solvent) to ensure that correct levels are maintained. Fill any low reservoirs, as needed.
- ✓ DO NOT SUBSTITUTE any other fluids for specified oils, transmission fluid, brake fluid, or other hydraulic fluids—substitutions are not acceptable and can void warranties.
- ✓ Before starting the motor home engine, make sure all lines (e.g., water, sewer) and electrical power cords are disconnected and properly stowed.
- ✓ Ensure that the leveling jacks are in the "travel" position and antennas are properly docked.



SAFETY

- ✓ After entering the motor home, make sure that the electrically actuated, retractable step has properly operated to retract the step fully before starting the engine of the motor home.
- ✓ Check all interior doors (e.g., shower, microwave, refrigerator, etc.) to ensure they are locked and/or secure. Make sure all large items are stored away and secure (e.g., coffee pots, corning ware, etc.).

DRIVING SAFETY

Various adjustments must be made to ensure the driver's comfort and the safety of the motor home before starting and moving the motor home; these include:

- Do not attempt to adjust the driver's seat while the vehicle is moving.
- Do not adjust the tilt steering while the vehicle is moving.
- The driver should be familiar with all gauges, instruments, switches, and indicators on the instrument panel before driving.
- Do not operate the cruise-control function during any extreme weather situations (e.g., snow, ice, sleet, heavy rain), or when road conditions are hazardous (icy, snowy, winding roads, city traffic), when a constant speed of the motor home is not possible, or if traffic conditions do not warrant such.
- Avoid driving the motor home through any standing water. If deep enough, such water can wet the brake pads and cause fading of the brakes (i.e., loss of braking power) and lead to excessive sliding or pulling to one side or the other.
- Know the limits of operation of the motor home. Do not try to achieve excessive speeds, climb overly steep hills, traverse overly long grades, attempt to use as an "off-the-road" (OTR), rapidly switch lanes, or rapidly accelerate or decelerate the motor home. When in doubt about the handling characteristics of the motor home, consult your chassis manual for information.
- The solar or blackout shade is operated by using a switch on the driver's console. Depress the switch to lower or raise the shade. On the Zephyr, the switch is labeled SOLAR SHADE or NIGHT SHADE. The time delay switch must be held for a few seconds before it is activated.



Figure 2-1: Driver's side Dashboard and Instrument Console



- **NEVER** drive the vehicle with a slide-out room extended.

SAFETY

FUELS FOR THE MOTOR HOME

Your Zephyr is designed to use diesel fuel only:

- Anytime the motor fuel is to be filled, turn OFF the motor home engine, all pilot lights, and appliances.
- DO NOT SMOKE when refilling the fuel tank.
- NEVER use any other “burning” equipment (e.g., charcoal grills, wood stoves, butane lights, propane lights) inside the motor home. Doing so might cause fires and/or asphyxiation.



DANGER

All pilot lights, appliances, and their ignitors must be turned OFF before refuelling of motor fuel tanks or propane containers. A failure to comply could result in serious injury or death.



WARNING

Any portable, fuel-burning equipment (e.g., charcoal, propane, butane, wood) must not be used inside the motor home. Any use of such equipment inside the motor home might readily cause fires and/or asphyxiation by carbon-monoxide poisoning. Moreover, such unauthorized use will probably invalidate your motor home insurance policy.

CARBON MONOXIDE WARNING



WARNING

Avoid inhaling exhaust gases as they contain carbon monoxide, which is a colorless, odorless, and poisonous gas. Serious illness, injury, or death can result.

SAFETY

A properly maintained engine exhaust and ventilation system is the best way to protect against carbon monoxide's entry into the vehicle. Tiffin Motor homes recommends that the exhaust system and body be inspected by a qualified motor home service center:

- Each time the vehicle is serviced for an oil change.
- Whenever a change in the sound of the exhaust system is noticed.
- Whenever the exhaust system, underbody, or rear of the vehicle is damaged.

To allow proper operation of the vehicle's ventilation system, keep the front ventilation inlet grill clear of obstructions at all times.

Do not occupy a parked vehicle with the engine running for an extended time, and do not run the engine in confined areas, such as a garage.

Your motor home is equipped with a combination CO/LP Gas Alarm (Figure 2-2). This alarm combines into a single compact system that detects both Carbon Monoxide (CO) and Propane (LPG) gas. It will detect carbon monoxide gas from any combustion source such as the furnace, oven/range, water heater, refrigerator, chassis engine, and generator engine.

CO/LP GAS DETECTOR

Since LP gas is denser than air, the LP gas will naturally settle to the lowest point in an enclosed space. In the motor home, this would be the floor. Because of this, the CO/LP gas detector (Figure 2-2) is necessarily mounted close to the floor.

To activate the CO/LP-gas sensor on this detector for the first time, remove the sensor activation strip, if it was not removed during the pre-delivery inspection.

If the alarm persists in re-arming and giving further alarms, ventilate the motor home by opening the doors and windows. After the ventilation process is concluded, shut all the doors and windows, and then take the motor home to a qualified service technician.

The CO/LP gas detector is a single compact system that provides a powerful combined alarm that detects both Carbon Monoxide (CO) and explosive gases, such as Propane (LPG) and Methane (Natural Gas). This detector uses the latest microprocessor technology combined with two electronic self-cleaning sensors that operate independently of each other. The combined unit can detect both CO and explosive gases simultaneously.

Carbon monoxide (CO) is a colorless, odorless, tasteless gas which, when breathed, bonds to the hemoglobin in the red blood cells and, thus, drastically reduces or blocks the transfer of oxygen from the lungs to the rest of the body.

In sufficient concentrations, CO kills by asphyxiation. In lesser amounts, CO makes the victim groggy, lethargic, and unable to think clearly or quickly.



Figure 2-2: Carbon Monoxide/LP Gas Detector

SAFETY

CO is one of the products of combustion for many materials including petroleum-based products (e.g., gasoline, diesel fuel, propane, butane, etc.). Since many of the appliances and the engines associated with the motor home produce CO in their normal operations, it is necessary to ensure that CO levels do not rise to dangerous levels within the motor home. In sufficiently high concentrations, CO can kill in minutes.

The people most susceptible to CO poisoning are unborn babies, small children, pregnant women, senior citizens, and people with cardiovascular or respiratory problems.

Consequently, it is prudent to check the CO monitor regularly for normal operation and to remain aware of the symptoms of CO poisoning, which include dizziness, nausea, vomiting, muscular twitching, throbbing in the temples, incoherent thinking and speech, weakness, sleepiness, and intense headaches.

If any of these symptoms are experienced in the motor home, IMMEDIATELY evacuate the motor home and seek medical help. Shut down the motor home and do not attempt to operate it again until the sources of the CO are located and fixed.



DANGER

Carbon monoxide gas—derived from products of combustion of diesel fuel, LP gas, and other petroleum-based products—is a deadly gas that can kill motor home occupants, if allowed to accumulate in sufficient concentration. Ensure that all engine operations are not restricted—tailpipes and exhaust ports should not be blocked or restricted in any way. Additionally, any accumulation of exhaust gases outside or underneath the vehicle must be avoided as it might enter the motor home through windows or vents—be careful of how and where the motor home is parked to avoid such conditions. Regularly monitor outside conditions to ensure that all exhaust gases can readily be dissipated and not enter the motor home inadvertently.



DANGER

Never sleep in a motor home when the engine is running—engine exhaust fumes could enter the motor home and cause disability or death. Regularly check the exhaust system to note any leakage sites and, if found, discontinue use of the motor home until they are repaired by a competent, qualified service technician. Do not attempt repairs on the exhaust system yourself and do not modify (temporarily or permanently) the exhaust system at all.

SAFETY

FIRE SAFETY

As with any enclosed system containing the three required conditions for fire (i.e., combustible materials, oxygen, and ignition sources), there will exist the possibility of fire inside the motor home. Tiffin Motor homes has taken every precaution and design practice to minimize or negate this possibility, but the final determination rests with the owner and user of the motor home. Hence, the owners, users, and their guests must be aware of basic fire-safety practices and procedures, and those particular features that Tiffin Motor homes has provided for fire safety.

FIRE EXTINGUISHER

The motor home is equipped with a fire extinguisher located in the entrance door stairwell (Figure 2-3). The extinguisher is rated for both Class B (i.e., grease, gasoline, diesel fuel, flammable liquids) and Class C (i.e., electrical) services.

Read and understand the accompanying owner's manual on the extinguisher (found in your Owner's Information Package) and remember the location of the extinguisher. These types of fire extinguishers are pressurized mechanical devices and require that appropriate care be used in their safe storage and use. The owner's manual will provide necessary guidance for the proper storage, handling, and use of the extinguishers.

Prudent preventive maintenance suggests monthly inspection of any fire extinguisher to ensure that it is sufficiently pressurized (i.e., the needle on the gauge is in the "normal" zone) and that the mechanical components are not blocked in any way.

DO NOT test a fire extinguisher by partially discharging the unit—this will cause a loss of pressure and might lodge some fire-retardant materials in the valve mechanism and cause the extinguisher to continue to vent slowly down to zero pressure. If an extinguisher is ever partially used, continue its use until the unit is completely discharged. Then, have the fire extinguisher fully recharged at an appropriate service center (call any fire department for information on having an extinguisher recharged in that particular locality).

DO NOT wait for to recharge an empty fire extinguisher; you'll never know when it might be needed.

Should a fire occur inside or around the motor home, evacuate the motor home quickly and calmly—do not panic. In the event of heavy smoke or extensive flames, keep low (crawl if you must), and make your way to the nearest exit (door, emergency window) and leave. If the fire involves a fuel source (e.g., diesel fuel, LP gas), consider the probability of an explosion and move sufficiently far away to minimize personal harm. If such is available, immediately place a call to the local fire department (or ask someone nearby to do so) to report the fire. Consider the cause and the consequences of the fire and the risks associated with possibly fighting the fire yourself before trying to extinguish it.

DO NOT expose yourself or others to unnecessary danger.



Figure 2-3:
Fire Extinguisher

SAFETY

SMOKE DETECTOR

The motor home is equipped with a battery-operated smoke detector (Figure 2-4) located on the ceiling in the living area of the motor home.

The smoke detector should be tested on a weekly basis, before each trip, and after any period of storage of the motor home.

If a low-battery condition is noted or the alarm “chirps” to indicate a low-battery condition, immediately replace the battery. Tiffin Motor homes recommends that you keep replacement batteries in the motor home for any in-transit replacements so that the smoke-alarm capability is never compromised.

DO NOT disable the smoke detector for any transient, false alarm (e.g., cooking smoke, dusty furnace, tobacco smoke). Ventilate the motor home with fresh air and the alarm will reset on its own.



Figure 2-4: Smoke Detector

ELECTRICAL

- Careless handling of electrical components can be fatal. Never touch or use electrical components or appliances while feet are bare, hands are wet, or standing in water.
- Improper grounding of the vehicle can cause personal injury.
- Do not attach an extension cord to the utility power cord.
- Do not use any electrical device that has had the ground pin removed.
- Avoid overloading electrical circuits. Replace fuses or circuit breakers with those of the same size and amperage rating only. NEVER use a higher rated fuse or breaker.

LOADING

- Store or secure all loose items inside the motor home before traveling. Possible overlooked items such as canned goods or small appliances on the countertop, cooking pans on the range, or free-standing furniture can become dangerous projectiles during a sudden stop.
- Be aware of GVWR, GAWR, and individual load limit on each tire or set of duals.
- Never load the motor home in excess of the gross vehicle weight rating or the gross axle weight rating for either axle.

SAFETY

MAINTENANCE

- Do not remove the radiator cap while the engine and radiator are still hot. Always check the coolant level visually using the see-through coolant reservoir.
- NEVER get beneath a vehicle that is held up by a jack only.
- Do not mix different construction types of tires on the vehicle. Replace tires with the exact size, type, and load range.

PARKING PROCEDURES

To park the motor home in any unfamiliar terrain, examine the site for surface irregularities, slopes, or inclines, and other items such as stumps, rocks, or external connections for power/water/sewage, and also examine the area immediately above the parking site for obstructions like tree branches and limbs, signs, and overhead wiring.

If the motor home is to be backed into the parking site, try to have that site be on the driver's left-hand side, as this will allow the driver to watch the rear of the motor home. Back up slowly and use the side mirrors and the back-up camera as a guide or, better yet, have another person outside provide guidance to help park the motor home.

When the motor home is finally situated, shift the transmission into park, set the foot-operated park brake, and then turn OFF the engine. Activate the hydraulic leveling system to level and stabilize the motor home.

If the motor home is to be powered externally, connect the 120 VAC power to the motor home. If the motor home uses LP gas, turn ON the LP gas valve at the LP tank. Connect the fresh-water supply and sanitize the water systems as needed. Connect the waste drain hose to the external sewer hook-up. Start the refrigerator, water heater, and furnace, as warranted. Light the oven pilot light, as needed. Certain appliances, such as the refrigerator, will not work properly, if the motor home is not level, so be sure to complete the motor home-leveling process before activating any of the appliances.

TOWING HITCH

The motor home is fully capable of towing typical motor vehicles.

The Zephyr is equipped with a 20,000 pound towing hitch (Figure 2-7), and associated wiring connector.

The towing hitch features a standard 7 pin wiring connector. If desired, a trailer brake actuator can be added. The plug for the actuator is located to the left of the steering column, underneath the dash.



Figure 2-7: Towing Hitch

SAFETY

The motor home is capable of towing light loads, and instructions are found in the chassis manufacturer's literature in the Owner's Information Package provided with the motor home.

The total weight of the motor home and any vehicle towed by that motor home must not exceed the Gross Combined Weight Rating (GCWR).

NOTICE

When the motor home is being weighed, remember to account for passengers and their locations in the motor home.

The tongue weight must not exceed 10 percent of the towing capacity. Information related to the motor home weight and GCWR can be found on a sticker inside the motor home closet. Any vehicles to be towed by the motor home should have adequate active braking.

Tiffin Motor homes does not recommend using any type of hydraulic towing lift that attaches to the rear of the motor home designed to carry motorcycles, scooters, golf carts, etc.

ZEPHYR

HEATING & AIR CONDITIONING

Chapter

3

HEATING & AIR CONDITIONING

AQUA-HOT HEATING SYSTEM

The Zephyr features an Aqua-Hot heating system (Figure 3-1) that provides a continuous, on-demand supply of domestic hot water, as well as interior zone heating.

Both heating features are accompanied by a unique VDC-powered diesel-fired burner, and a VAC-powered electric heating element (120 VAC). These two heating sources maintain the temperature of the Aqua-Hot's solution of water and propylene glycol.

If interior heat and hot water are both needed at the same time, the hot water will take precedence over the interior heat, causing the interior heat to shut down and turn off until the water flow is turned off from the water sources.

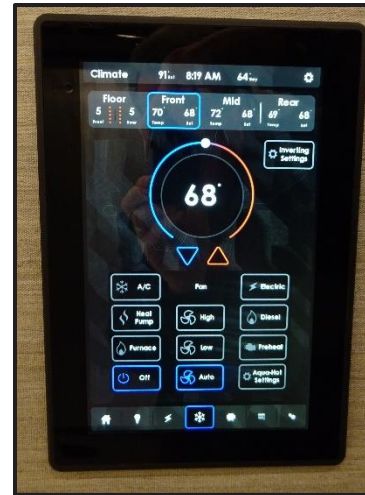

Figure 3-1: Aqua-Hot Heating System Control Screen



Figure 3-2: Aqua-Hot Surge Tank

To activate the Aqua-Hot heating system, there is a switch labeled "diesel burner switch" located in the side cabinet above the driver's seat. By activating this switch, a supply of hot water as well as interior heat can be provided. The heating feature will be controlled by the thermostat mounted on the wall.

The surge tank (Figure 3-1), which is located in the basement, should be routinely inspected to make sure the propylene glycol fill line stays in the acceptable zone. If the propylene glycol becomes low, you must add the recommended propylene glycol stated in the Aqua-Hot owner's manual.

If propylene glycol is totally depleted from the surge tank, a switch will be released inside the main Aqua-Hot tank, disabling the system from operating. Propylene glycol will then have to be added to the tank to reactivate the switch and allow the system to operate. If batteries become discharged and the Aqua-Hot system is activated, the system will automatically shut down before the batteries are totally discharged. Once power is restored to the batteries, the system must be reset by depressing the reset button on the black panel of the surge tank. For detailed operations on using the heating System, refer to the owner's manual in your Tiffin Owner's Information Package.

NOTICE

The recommended propylene glycol is a non-toxic form of anti-freeze.

HEATING & AIR CONDITIONING

NOTICE

Yearly maintenance is required on the burner portion of the Aqua-Hot heating system.



CAUTION

The Aqua-Hot heating system operates off the motor home's diesel tank. Keep in mind that the Aqua-Hot fuel tube is located higher in the diesel tank than the motor home's engine fuel in order to prevent complete depletion of the diesel fuel tank. **BE SURE AN ADEQUATE AMOUNT OF FUEL IS IN THE TANK BEFORE DRY CAMPING.**



CAUTION

DO NOT operate the diesel burner and/or the electric heating element without the water and propylene glycol solution in the Aqua-Hot's boiler tank. Failure to do so will cause **SERIOUS DAMAGE** to the heater.

AIR CONDITIONING SYSTEM

The factory-installed air-conditioning system is designed for 120 VAC power supplied either from the external power cord or from the generator. For the best cooling scenarios, park the motor home in a shaded location whenever possible and close drapes on the windows exposed to direct sunlight.

The air-conditioned, cooled air is emitted through the vents (Figure 3-3 to Figure 3-4: Vent Filter), which are located in the roof throughout the entire coach along the passenger side. The return air vents run parallel, front to back, on the ceiling along the driver's side of the coach. The return vents are similar to the air conditioning vents, but they contain foam filters that keep dust from flowing back through the air conditioning system. The return filters can be easily removed and cleaned with warm water and a mild cleaning solution. To remove the filter, pull the vent down and lift the filter from inside the opening.

HEATING & AIR CONDITIONING



Figure 3-3: Right Vent

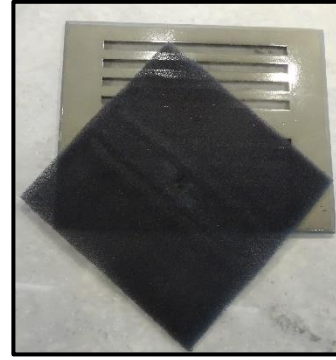

Figure 3-4: Vent Filter

NOTICE

The air conditioning system is the major consumption device of electrical power in the motor home. When this system is being used in an RV park, cumulative use of these air-conditioning systems by the resident vehicles can create a bigger demand for electrical power than is actually available. Accordingly, at times, a “brown-out” condition might arise. This is when the AC voltage normally available drops to a lesser value (e.g., 10-20% below normal or more).

“Brown-out” conditions cause appliances to draw greater currents to make up for the reduced voltage; thereby causing circuit breakers to trip or fuses to blow. Under such conditions, your own motor home is not at fault; reset your breakers and/or replace your fuses. Should such conditions continue, reduce the electrical load (in this case, turn OFF the air conditioning system for a while) or start the electrical generator.

AIR CONDITIONING CONTROLS

The following is a brief overview of how best to operate the air conditioning (A/C) controls. The A/C controls are integrated into the Spyder Controls Multiplexing System, and can be found on any of the touch screens. To access the A/C controls, touch the temperature icon located on the 10” touch panel in the hallway, or use one of the 7” or 5” touch panels. These are located throughout the coach. To activate the desired A/C, select A/C on the touch panel. Once pressed, the A/C button will begin flashing. The right side of each A/C control panel will indicate the fan speed (HIGH, LOW, or AUTO). The default setting for the fan speed is AUTO. This can be changed by pressing LOW or HIGH. When the A/C is in the AUTO mode, a fan icon below the arrows will indicate the fan speed. In AUTO mode, once the temperature reaches the set point, the compressor (indicated by a blue snowflake changing to gray) will cut off first, and then the fan will shut off after. If the fan speed of HIGH or LOW is selected, the compressor will shut off, but the fan will stay on when the set point for temperature has been reached.

HEATING & AIR CONDITIONING

NOTE: If the motor home temporarily loses its 110V power, the air conditioning system will resume operation at its last programmed setting when power is restored. If 12V power is lost, the thermostat settings will turn off, and the climate control must be turned back on.

NOTE: The A/C and heater cannot operate at the same time.

THERMOSTAT ON SPYDER CONTROLS SYSTEM



Figure 3-5: A/C Thermostat Control on 5-inch Panel

The following is an overview of how best to use the thermostat (Figure 3-5). For more detailed instructions, refer to the thermostat literature in the Owner's Information Package.

Push the THERMOMETER icon on the Spyder Controls System. This will bring up a touch screen to select the desired function (e.g., A/C, HEAT PUMP, FURN, or OFF).

NOTE: In the A/C mode, there will be a delay of several minutes before the refrigerant in the air-conditioning system begins to cool the motor home, as the compressor is on a time delay circuit and it must also cool the ductwork to the vents first.

Select the Fan Mode operation (AUTO) or set the Fan Speed operation (LOW or HIGH) to select the fan speed desired.

Press the Up and/or the Down buttons to set the desired temperature for the motor home.

NOTE: When the fan is on AUTO mode, the fan will turn on and off when the temperature reaches the desired setting.

When the fan is on LOW or HIGH mode, it will continue to run even though the compressor cycles on and off when it reaches the desired temperature.

If the motor home temporarily loses its 110V power, the air conditioning system will resume operation at its last programmed setting once power is restored.

HEATING & AIR CONDITIONING

If 12V power is lost to the thermostat, it will automatically reset to 72 degrees once power is restored.

HEAT PUMP CONTROLS

To activate the HEAT PUMP on the Spyder Controls Screen, press the HEAT PUMP button (Figure 3-58) and select desired temperature.

NOTE: If the setting on the thermostat and the room temperature are more than five degrees apart, the gas furnace will automatically turn ON with the heat pump. Once the room temperature reaches the desired level specified on the thermostat setting, the furnace will cut off and the heat pump will maintain the heating of the coach.

If the external temperature falls to 35-38 degrees Fahrenheit, the heat pump will become inoperative and the gas furnace will begin to operate automatically.

NOTE: The heat pump refers to the electric strip on each exterior rooftop A/C. The FURN button refers to the Aqua-Hot.



Figure 3-6: Heat Pump Controls

ZEPHYR

MAJOR APPLIANCES

Chapter

4

APPLIANCES & ACCESSORIES

RESIDENTIAL REFRIGERATOR

The Zephyr is equipped with a 110 volt style residential refrigerator (Figure 4-1), which is powered from an outside source, or from the unit's generator or inverter, which uses a 12 volt battery power supply.

This unit operates as most home refrigerators do.

NOTE: While traveling, the refrigerator will be powered by the inverter.

For further operating and maintenance instructions, refer to the operating booklet found in the Owner's Information Package.

NOTE: While traveling, the 12 V battery is charged by the engine alternator.

The inverter must be ON for the residential electric refrigerator to operate, if not connected to shore power, or the generator.



Figure 4-1: Residential Refrigerator

MICROWAVE/CONVECTION RANGE

The Zephyr contains a microwave/convection oven (Figure 4-2). All microwave ranges operate on 120-volt AC electrical power, supplied either by the external electrical hookup or by the on-board electrical generator in the motor home.

Touchpad controls are used for operating the convection microwave (i.e., cooking temperature, mode, power level, and cooking time). For basic operating instructions, care, and maintenance for the proper use of the microwave, refer to the specific manual in the Owner's Information Package.



Figure 4-2: Microwave

APPLIANCES & ACCESSORIES

AIR FILTRATION FAN



Figure 4-3: Air Filtration Fan

In the motor home, the “exhaust” or air filtration fan (Figure 4-3) is built into the microwave, and its function is to filter the air and exhaust to the outside.

The filtration fan should be used whenever cooking is performed to filter any airborne cooking residues and heated air.

The filtration system can be used as supplemental filtration of other odors and gases including tobacco smoke, candle fumes, and related vapors. It contains filters, which can be removed and cleaned or replaced to ensure normal operation. Consult the particular owner’s manual contained in the Owner’s Information Package for more information.

APPLIANCES & ACCESSORIES

COOKTOP

The Zephyr is equipped with a two-burner induction cooktop (Figure 4-4) that requires 50-amp service, or the generator, to operate.

The control panel features options on operating the following settings:

HEATING — This is the default function of the induction cook top. When pressing ON/OFF, the heating light will illuminate and the cook top will heat the cookware at 1200 W. The heat can be adjusted by touching the UP or DOWN arrows. There are 10 levels of power, with 10 being the highest.

TEMPERATURE — When pressing TEMP, the induction cook top will begin setting the temperature and the TEMP light will illuminate. The default temperature is 248 degrees Fahrenheit (120 degrees Celsius). The temperature can be adjusted by touching the UP or DOWN buttons.

NOTE: The temperature range is 140 degrees to 420 degrees Fahrenheit for a single “eye” (60 to 215 degrees Celsius).

TIMER — When pressing TIMER, the light of the TIMER and one of the lights on HEATING/TEMP will illuminate accordingly. The cook top will enter the Time Setting mode. Five seconds after setting, the window will automatically shift to the mode display of the corresponding function. To view the countdown time, press TIMER again. The display window will show you the remaining time.



Figure 4-4: Two-Burner Induction Cook Top



WARNING

DO NOT USE cooking appliances as a heating source for the motor home. Cooking appliances require fresh air for safe operation. Before using any cooking appliance, make sure that an overhead vent or window is open and/or turn ON an exhaust fan. **DO NOT** place stove covers on cook top until it is cooled.

APPLIANCES & ACCESSORIES



DANGER

All LP gas-operated appliances in the motor home will consume oxygen. If the motor home is totally closed during such operation, the oxygen level might be reduced and the associated carbon monoxide level might be increased thereby causing possible harm or death to the occupants through asphyxiation. Always use these appliances with proper ventilation.



WARNING

Portable fuel burning equipment, including wood and charcoal grills and stoves, should NEVER be used inside the motor home. The use of this equipment inside the coach can cause fire or asphyxiation and could result in serious injury or death.



DANGER

IF YOU SMELL GAS, YOU SHOULD IMMEDIATELY:

Extinguish any open flames, pilot lights, and all smoking materials. Do not touch or operate any electrical appliances or switches. Immediately shut off the gas supply at the main tank valve or supply connection. Open doors, windows, and other ventilation openings. Exit the RV to allow entrapped LP gas to dissipate. Have the LP gas system checked to locate and fix the sources of the leakage.

APPLIANCES & ACCESSORIES

DISHWASHER

The Zephyr might be equipped with a compact dishwasher (Figure 4-5). The following operating instructions can be used to operate the dishwasher:

Load the dishes.

Add any detergent and rinse-aid solution.

Press the POWER button to turn the dishwasher ON (pushing this button again will turn the dishwasher OFF).



Figure 4-5: Dishwasher

NOTE: Opening the dishwasher will automatically turn ON the dishwasher for a 30 second period. To end a wash cycle before it is fully completed, press the POWER button; the dishwasher will pump any remaining water in the dishwasher out of the unit.

Select Wash Program. By pressing the PROGRAM button, the desired wash cycle can be selected. The dishwasher will remember the last selection made until a newer one is selected.

Check to ensure that the drain filter is flush with the filter plate and the spray arm can rotate within the dishwasher freely without affecting anything.

Start the dishwasher by closing the dishwasher door; then press the START/PAUSE button to begin the washing cycle. This button also has a DELAY START function.

Pause the dishwashing cycle, if desired, by pressing the START/PAUSE button; wait for three beeps to be heard, and then open the dishwasher. Restart the dishwasher (after closing the door) by pressing the START/PAUSE button.

NOTE: Forcing open the dishwasher door mid-cycle might cause damage and/or injury.

Finish the dishwashing cycle by noting when the dishwasher beeps six times to indicate the end of the wash cycle. At the end of the washing cycle, the drying fan will continue to run for a pre-determined time or until the door is opened. The drying fan assists in drying the washed contents and actually uses very little electrical energy in the process. It is normal for some water to remain in the drain filter area after the wash cycle is completed.

NOTE: Should a power failure occur when the dishwasher is operating, the dishwasher will stop. It might be impossible to open the dishwasher, depending on where it was interrupted in the dishwashing cycle. When the power is reapplied, the dishwasher will resume its operation at the point at which it was interrupted. When not in actual use, the dishwasher can be used to store dishes, cups, glasses, etc.; as the dishwasher itself provides secure storage for these items while in transit.

APPLIANCES & ACCESSORIES



WARNING

The dishwasher must have 110V power or inverter power at all times to stay locked during transit. If not, the dishwasher could disengage during travel.

To ensure that the dishwasher is properly locked for travel, follow the steps below:

Push the center control located on the face of the dishwasher until it blinks green. Press the key button to the right of the center button until it turns red and compresses. This denotes that the dishwasher is in “lock down” mode.

To decompress the dishwasher, push the key button for five (5) seconds.

STACKED WASHER/DRYER

Your Zephyr might be equipped with a stacked washer/dryer (Figure 4-6). The optional stacked washer/dryer can operate on 30 or 50-amp service.

NOTICE

Tiffin Motor homes does not recommend operating the washer or dryer while traveling as this could damage internal components.

For specific information regarding the use of the stacked washer/dryer, consult the owner’s manuals found in the Owner’s Information Package.

NOTE: The 1 ½” gray-water valve at gray tank waste gate must be fully open when operating the washer/dryer.



Figure 4-6: Stacked Washer/Dryer

ZEPHYR

ENTERTAINMENT

Chapter

5

ENTERTAINMENT

TELEVISION SYSTEM OPERATION

TELEVISION ANTENNA

You can automatically search for channels that are active in your area by editing and scanning channels on your remote control. To set up the television, refer to the television instruction manual provided.

NOTE: The antenna booster is located in the front, right cabinet of your unit, and must be ON when using the antenna, and OFF when using cable.

NOTE: If the motor home has been moved, the channels must be rescanned on each TV.

NOTE: Due to Tiffin Motor homes' commitment to continuous research and development, some units might also contain televisions manufactured by other companies (LG, Samsung, etc.). Refer to the information in your Owner's Information Package on setup for the brands.

TELEVISION SATELLITE DISH

Your motor home is equipped with an in-motion TV satellite dish control system (Figure 5-1) to permit access to satellite television. The satellite is equipped with a high-definition receiver.

The motor home satellite is capable of receiving High Definition (HD) satellite signal from Dish Network. However, you must subscribe to HD service.

The dome satellite, on top of the coach, can be raised to allow easy access to change switches to a new satellite provider.

Follow the directions in the Owner's Manual for this dish-control mechanism to obtain the best orientation of the satellite dish for desired television reception.



Figure 5-1: Dome Satellite

ENTERTAINMENT

To set up your satellite receiver for Dish Network (Factory Configuration):

Remove the satellite dome cover on top of the motor home by releasing the screws around the dome.

Change dish settings to 4-7-8 by adjusting the dipswitches to the DOWN position (8 is already in the DOWN position).

Re-install the dome.

On the Dish remote:

Press MENU.

Press the no. 6 button.

Press the no. 1 button.

Press the no. 1 button again.

This will bring up the Dish screen. Go to the right-hand column where it says "CHECK SWITCH."

Once this is done, EXIT the system, and then press 0-0-0 to download the information.

TELEVISION SETS

Your motor home is High Definition (HD) ready and is capable of receiving channels that are broadcasting in High Definition.

In order to receive a clear picture from your satellite dish, you must subscribe to High Definition (HD) service. Your motor home is equipped with an automatic switching box that enables you to easily change between TV input modes.

To change the mode of your television, press INPUT on your remote control. Then, select TV, Blu-ray, or Satellite, and press OK.



Figure 5-2: Living Area Television Set

NOTE: The booster must be ON for the antenna and OFF for the cable. The television sets (Figure 5-2) are located in different areas of the motor home. All TV sets are High Definition.

The televisions are powered by 120 volt AC electricity; therefore, the motor home must either be plugged into an external source of AC power or using on-board power from the generator. An optional inverter would also permit the 12 volt DC power to be converted into 120 volt AC for the televisions.

Detailed operation of the televisions is provided in the accompanying owner's manuals found in the Owner's Information Package included with the motor home.

ENTERTAINMENT

TELEVISION LIFT

NOTE: The inverter must be ON to use the TV lift function.

OPTIONAL TV LIFT IN LIVING ROOM

The Zephyr can be equipped with a TV lift in the living room area (Figure 5-3 and Figure 5-4).



Figure 5-3: Television Lift (Before Lift)



Figure 5-4: Television Lift (Lifting)

The Television Lift mechanism can be operated using any of the touch screens located throughout the unit.

TV IN BEDROOM

The Zephyr can also be equipped with an TV lift in the bedroom area (Figure 5-6).

The TV Lift mechanism can be operated using the touch screens located on the end walls of the bedside box (Figure 5-7) or by pressing the buttons on the TV lift key fob (Figure 5-5).



Figure 5-7: Rear TV on 7" Touch Screen



Figure 5-6: Rear TV

ENTERTAINMENT

INFRARED REPEATER

The motor home features an infrared repeater, which enables the owner to utilize the satellite remote control from various areas of the coach. An infrared repeater will be located in the bedroom and by the overhead TV located in the driver's area. If your motor home has the optional outside entertainment system, this feature will be located on it also.

To utilize the infrared repeater, locate the one inside the cabinet that contains the DVD player. Peel the adhesive backing from the back of the infrared repeater and line the infrared repeater against the satellite receiver's infrared repeater. This will allow the infrared repeater to operate when the satellite remote You will now have the convenience of changing the satellite receiver channels from various areas of the coach.

NOTE: The infrared repeater will not work with a Dish Network receiver.

SOUND BAR

The sound bar in Bedroom room automatically comes on with the TV. No setup is required.



BLU-RAY PLAYER

The standard Blu-ray player (Figure 5-9) is located in a vented cabinet in the bedroom of the coach.

The player allows accessibility to play, Blu-ray, iPods, and other electronic devices as well as viewing photos and playing music.

Detailed operation of the player is provided in the accompanying manuals found in the Owner's Information Package included with the motor home.



Figure 5-10: Player

ZEPHYR

CABINETS & FURNITURE

Chapter

6

CABINETS & FURNITURE

CABINETS

Your Zephyr contains cabinetry (Figure 6-1) installed throughout the entire motor home from the driver's area, through the kitchen/dining areas, and back into the bedroom.

The cabinetry is available in contemporary and traditional fascia, and has been designed and built to provide ample storage space, to be easily accessible, and to be conveniently located to support the areas of concern.

Construction of these cabinets incorporates various hardwoods, raised panels, cabinet doors, and supports. Door pulls, handles, and knobs are installed in a style complementing the particular décor of each motor home so that an aesthetically pleasing, as well as fully functional, storage capacity is realized.

For the many floor plans available in the Zephyr product line, cabinet design has been optimized to provide maximal storage for each floor plan available. Accordingly, the Zephyr can readily accommodate the routine materials, supplies, and customer-specific items desired for any travel requirements.

These cabinets are designed to contain stored supplies quite securely during travel to minimize or eliminate the possibility of shifting or spilling of cabinet contents during travel. However, when the motor home is parked, all stored items are readily available in the cabinets for the convenience of the users.

As the storage requirements will vary somewhat from one floor plan to another, general observations can be made about the Tiffin-supplied cabinetry, which might or might not be applicable for your specific motor home configuration.

Cabinets are provided in the kitchen/dining area to accommodate the routine cooking utensils and groceries normally required for travel. Storage space within these cabinets has been designed to accommodate the typical sizes and configurations of food supplies (e.g., cereal boxes, condiments, canned goods, bottled liquids) normally taken on travel trips.

Based on Tiffin Motor homes' extensive experience with travel requirements of the seasoned motor home users and from Tiffin Motor homes' own research and development in cabinet design requirements, the cabinets offer the greatest storage capacity possible.

In the bathroom and bedroom, additional cabinets are available for storage of sundries and toiletries specific to these areas.



Figure 6-1: Living Room Cabinets

CABINETS & FURNITURE

In the kitchen, a color-coordinated countertop is provided on top of the floor-mounted cabinets (Figure 6-2). To maintain the appearance of the countertop, clean with a damp cloth. If spotting occurs, clean the



Figure 6-2: Kitchen Cabinets

countertop with a damp cloth and a mild liquid soap. Should some dried-on residue still persist, let a damp cloth moistened with the liquid cleaner stand directly on top of that residue for 15-30 minutes to loosen the residue, then clean that spot accordingly.

NOTE: Strong chemicals, solvents, and cleaners (e.g., oven cleaner) might damage the surface; so do not use any

products not specifically designed for countertop cleaning.

The countertop might be physically damaged, too, if proper care is not taken. Do not cut anything (e.g., vegetables, fruits) directly on the countertop; rather, use a cutting board on top of the countertop to provide necessary protection. Excessive heat might also damage the countertop; therefore, any pots or pans taken directly from the range or oven must not be placed directly on the countertop; rather, use trivets or some other form of fireproof heat insulators to hold very hot pots or pans on the countertop.

All drawers are equipped with metal slides to provide additional load-bearing strength, and to permit effortless opening and closing of the drawers, even when they are fully loaded. These metal guides have a slight “locking” action, when closed. To open the drawers, slightly lift up on the drawer handle and then pull the drawer open.

To close, push the drawer closed until it “clicks” back into place (i.e., the locking action is engaged).

As this cabinetry is typically of furniture-grade quality, any commercial furniture polish or cleaner can be used. Do not try to soak these wooden surfaces with any water or any other liquid; be sure to wipe up spills or residues of any fluids that contact these surfaces to preclude any staining or discoloration of the cabinet surfaces.

CABINETS & FURNITURE

FURNITURE

KITCHEN, LIVING & DINING AREAS

On the Zephyr, a built-in dinette booth (Figure 6-5), is standard. This dinette provides additional storage under the seat area of the booth, in addition to providing additional sleeping facilities.

To convert the dinette into a bed:

Remove seat back and side cushions.

Slide seat bottoms back.

Flip the lever underneath the table to release the table down.

Reinstall the seat back cushions and back rests to make up the mattress for the bed.



Figure 6-5: Dinette

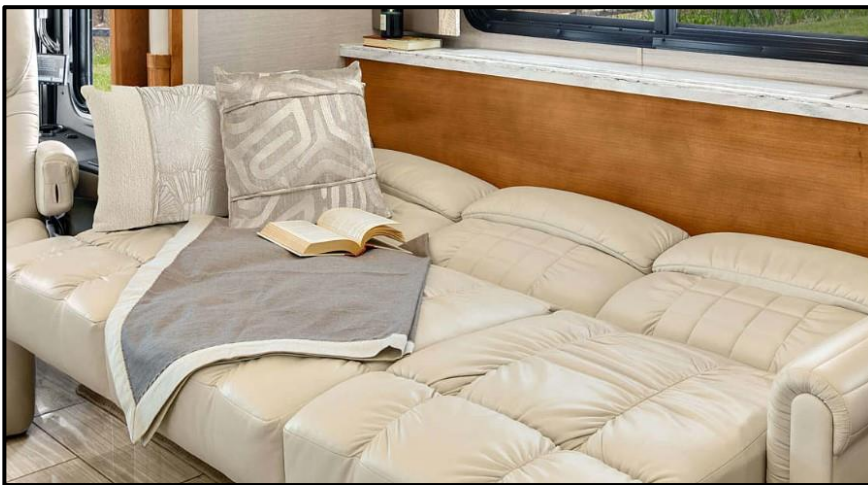

Figure 6-6: Sofa

To convert the sofa into a bed:

Remove the accent pillows.

Under the seat cushion, locate the “black tab” and slide the tab to the left or the right, and then pull upwards on the seat portion of the sofa—this will cause the sofa seat to open, extend, and convert into a bed.

The driver’s seat is manually operated and has swivel features. When the motor home is parked, the driver’s seat can be swiveled to face into the living room. To swivel this chair, first extend the slide-out room (see Chapter 9). Then, move the chair backwards as far as possible to gain clearance from the steering wheel. Now the chair can be swiveled without interference.

The living room contains a sofa (Figure 6-6) which converts into a bed. It may be one of two styles—either a standard jack knife bed, or an optional air coil hide-a-bed sofa sleeper. The optional air coil hide-a-bed sofa sleeper includes an air pump. It operates by depressing the black latch and unfolding the bed. The sofa is custom coordinated with the décor of the motor home.

CABINETS & FURNITURE



Figure 6-7: Driver and Passenger Chairs
(swivelled to the living area)

The passenger's seat (Figure 6-7) is also a manually operated seat having essentially the same controls as that of the driver's seat, and it is operated accordingly. The passenger's seat provides a comfortable footrest for your use.

BEDROOM AREA

If a décor-coordinated, quilted bedspread with accessorized pillow shams and accent pillows (Figure 6-8) are included with the bedroom suit, Tiffin Motor homes recommends that the bedspread be only dry-cleaned to preserve the quality of the bedspread for the longest time possible.

Treatment of the bedspread with any of the stain-resistant sprays (e.g., Scotchgard, etc.) will also make the bedspread more resistant to stains and fabric damage and, thus, provide many years of dependable service.



Figure 6-8: Bedroom Décor

CABINETS & FURNITURE

REAR EGRESS DOOR (OPTIONAL)

Your Zephyr may be equipped with an emergency read egress door (Figure 6-8a) located in the bathroom over the toilet.



Figure 6-8a: Read Egress Door

CABINETS & FURNITURE

POWER SMART BED (OPTIONAL)

Some Zephyr models have the Power Smart Bed option. This option allows the bed to be adjusted to different positions: (a) sliding the mattress out from the wall to aid in making the bed, (b) raising the head of the bed for reading and watching television, and (c) placing the bed in a horizontal position against the headboard.



Figure 6-9: (a)



Figure 6-10: (b)



Figure 6-11: (c)

To adjust the positions, a touch pad is located at the bedside (Figure 6-12).

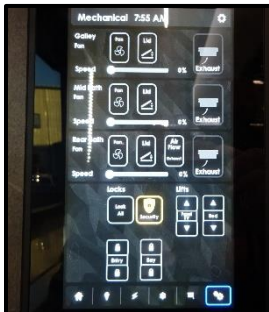

Figure 6-12: Rear Bed Lift on 7" Touch Screen

ZEPHYR

STRUCTURAL FEATURES

Chapter

7

STRUCTURAL FEATURES

CHASSIS FEATURES

The chassis of your Tiffin Motor homes Zephyr was built by and is warranted by Powerglide®Chassis . The operating instructions for the chassis are included in the Chassis Owner's Manual, which is provided with your Zephyr and is a part of the Owner's Information Package furnished to you by your Tiffin Motor homes dealership.

Before you begin using your Zephyr, read and follow all recommendations for the proper care, operation, and maintenance of the chassis—this will ensure a pleasant, trouble-free use of the vehicle. If you have any questions about the chassis, however, contact Tiffin Motor homes.



Reflecting over four decades of innovation, Tiffin's proprietary PowerGlide Chassis demonstrates our ongoing commitment to delivering a motor home experience that's precisely engineered for durability, reliability, performance, and control wherever your journey takes you.

ZEPHYR

ELECTRICAL FEATURES

Chapter

8

ELECTRICAL FEATURES

GENERAL INFORMATION

There are two electrical systems in your motor home. These are the 12-volt DC (VDC) system and the 120-volt AC (VAC) system. Most standard appliances require the 120 VAC system, while the majority of the lighting systems used in the motor home use the 12 VDC electrical system.

The electrical power for the 12 VDC system is supplied by the batteries of the motor home. Those batteries are charged by a power converter. The alternator also charges the batteries when the engine is running.

The electrical power for the 120 VAC is supplied by the power cord when the motor home is connected to an external power source or when the on-board electrical generator is in operation. The converter/inverter can also supply 120 VAC electrical power (to limited outlets and limited appliances)—the inverter transforms the 12 VDC electrical power from the batteries into the 120 VAC electrical power for the basic appliances.

Your unit is pre-wired for solar panels (optional). If you do have solar panels (Three or Six), the controls are located in the Spyder System. (Figure 7-1)



Figure 7-1 Solar Controls

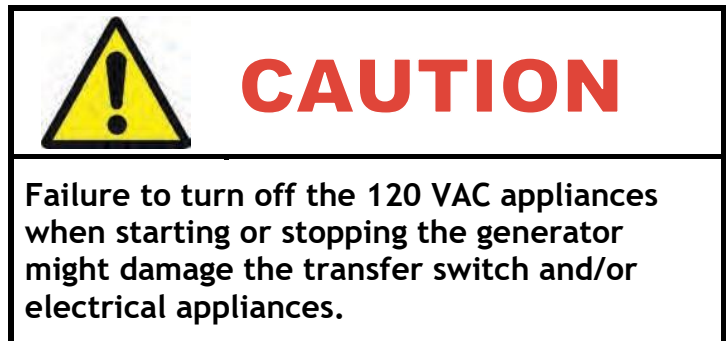

To connect the motor home to an external source of 120 VAC electrical power, Tiffin Motor homes recommends that all of the circuit breakers be in the OFF position, (this is done to prevent any power surge when connecting the motor home to the external power source), and then unwind the power cord from the electrical compartment located in an external compartment. The standard, flexible, power cord supplied with the motor home is designed to handle up to 50 amperes. Make sure that the pins in the male end of the plug are oriented correctly so that they match the power cable, and that they are in good condition (i.e., are not bent or damaged).

If there is a circuit breaker switch at the “plug” end of the power cord, that breaker should be turned OFF before making the connection. Insert the plug into the mating outlet, and then turn the circuit breaker ON. Close and lock the electrical compartment door to protect the contents and to keep them clean and dry. Close the cover on the power box, if so equipped, to avoid an unintentional disconnection and to keep the contents clean and dry. Then switch the main breaker to the ON position.

When properly connected, the 120 VAC system provides power to all the 120 VAC circuits and outlets when the main breaker is turned ON.

ELECTRICAL FEATURES

ELECTRICAL CAUTIONS



CAUTION

- Careless handling of electrical components can be fatal. Do not touch or use electrical components or appliances while feet are bare, hands are wet, or standing in water or on wet ground.
- Do not touch an extension cord to the utility power cord.
- Avoid overloading circuits and replace fuses or circuit breakers with those of the same size and amps only. DO NOT use a higher rated fuse or breaker.
- Do not plug the utility power cord into an outlet that is not grounded.
- Do not adapt a plug to connect to a receptacle that it is not designed for.
- Be sure that all electrical appliances used inside the motor home contain three-prong plugs for proper grounding.
- Use caution when handling or working near electrical storage batteries.
- Always remove jewelry and wear protective clothing and eyewear when working on an electrical matter.

CIRCUIT BREAKER BOXES

Interior 120 VAC and 12 VDC breaker boxes (Figure 8-1) vary depending on your specific floorplan; however, they are located inside the motor home.

The circuit breakers and associated fuses are installed to protect the electrical system of the motor home from any overloads. Do not attempt to change the electrical circuitry or to add appliances yourself.

Fusing is provided for 12 VDC circuits, such as: interior decorative and overhead lighting, water heater, TV switching box, slide-out lights, power roof vents, monitor panel, and the passenger side console switch panel.

Additional House 12 VDC breaker boxes are typically located in the front storage compartment on the driver's side; these fuse panels provide protection for the following circuits: mirrors, fog lights, hydraulic jacks,



Figure 8-1: Circuit Breaker Box

ELECTRICAL FEATURES

camera, wipers, docking lights, dashboard panels, spot light, power seats, radio, step cover, satellite receiver, 30 ampere ignition breaker, 50 ampere ignition breaker, and dashboard air circuit breaker.

Located on the passenger-side rear compartment is another circuit panel, which contains the following circuit breakers: slide-outs, 12 VDC disconnect storage box lights, and solenoids.

**WARNING**

To protect the 12 VDC system, DO NOT STORE anything in circuit panel compartments (e.g., toolbox), which might jostle around, break through the shield, and short out the 12 VDC system. If this system were short-circuited, extensive damage and/or fire could result.

AUXILIARY START SWITCH



Figure 8-2: Auxiliary Start Switch

The auxiliary start switch (Figure 8-2) is located on the switch panel to the left of the steering wheel in front of the driver's-side console box.

This switch connects the motor home coach batteries to the chassis batteries—this allows the chassis batteries to “borrow” power from the coach batteries to assist in starting the engine.

If the chassis batteries cannot start the engine by turning the ignition key, hold down the battery-boost switch for at least 60 seconds and retry starting the engine.

When attempting to use the auxiliary start switch function, Tiffin Motor homes recommends that you press and hold the switch for about 60 seconds before trying to start the engine. This gives the two sets of batteries (house and chassis) a chance to equalize before engaging the starter. The multiplex system that controls most chassis functions will need to reach optimal voltage range to ensure proper operation as well.

ELECTRICAL FEATURES

BATTERY INSPECTION AND CARE



Figure 8-3: House Batteries

The motor home batteries (Figure 8-3) are located on a sliding tray, which extend from an underneath compartment.

When batteries are not used for extended periods, they will gradually lose their electrical charge. Therefore, it is necessary to periodically recharge the batteries to increase the operational lives of the batteries.

It is also necessary to check the external condition of the batteries on a regular basis. Look for cracks in the battery case and cover. Check the vent plugs and replace them if they are cracked or broken. Keep the

battery clean.

Since accumulations of dirt and acid residue around the battery terminals might provide an electrical path for discharging the battery, the area around the terminals should be cleaned periodically.

You can use an old toothbrush and a sparse amount of a diluted solution of baking soda (sodium bicarbonate) and water (distilled or de-ionized, preferred; tap water, acceptable) to clean and neutralize any acidic build-up around the battery terminals. If there is any foaming on the top of the battery, this indicates that acidic residues are being neutralized. Rinse the cleaned areas thoroughly with distilled or de-ionized water (tap water is okay, too).

Avoid getting the baking-soda solution into the battery fill plugs to each battery cell; this would drastically reduce the effectiveness of the battery (by neutralizing the sulfuric acid in the battery cells) or, worse, “kill” the battery. Dry the battery cables and terminals to prevent corrosion; to protect those terminals further, use a plastic ignition spray on the terminals. Do not use grease on the terminals, especially on the metal-to-metal connections, as grease might act as an insulator and keep the battery electrical power from entering the cables.

If the batteries are not going to be used for an extended period, remove them from the motor home and store in a warm, dry place. Tiffin Motor homes recommends that this service be performed by a qualified service technician, as the process is usually too complicated for the average owner to perform. For those who might wish to perform this service themselves use the following procedure: Mark the battery cables (“+” sign or “red” for the positive cable; “-” sign or “black” for the negative cable) so that they can be properly reconnected again later. These batteries require periodic recharging to maintain their full charge.

Over time, the batteries will lose some of the water used with the sulfuric acid in the batteries. Following manufacturer’s recommendations as found in the Owner’s Information Package, periodically check the fluid levels in all the cells of the batteries (be sure to use safety eyewear during this process) and fill those that are low with water (distilled or de-ionized water is preferred; tap water is okay).

Do not overfill the cells; follow the filling directions exactly. Check the battery on a regular basis to realize the fullest service possible from the batteries over the longest time possible.

If the motor home is to be stored for an extended period, disconnect the 12 VDC battery system—this procedure will prevent unnecessary drain and corrosion of the batteries and their terminals.

ELECTRICAL FEATURES

LITHIUM BATTERIES (OPTIONAL)

NOTICE

Disconnect the 120 VAC electrical power cord and the negative terminal from the coach batteries **BEFORE** working on the motor home electrical system.

NOTICE

If the motor home ever requires any welding operations on the frame, first disconnect the chassis batteries. Failure to do so will destroy all of the chassis computer system.



WARNING

Remove rings, metal watchbands, and any other metal jewelry before working around batteries. If any metallic object (tool, jewelry, etc.) contacts the positive battery terminal or any connection made to that terminal **AND** also contacts the negative terminal or any of its connections, a **SEVERE ELECTRICAL SHORT** will occur, which could result in an explosion, fire, and/or personal injury. Lead-acid batteries contain diluted sulfuric acid, which can be dangerous; avoid direct contact with any battery fluids. Wear eye protection.

ELECTRICAL FEATURES

HOUSE BATTERY DISCONNECT PANEL



Figure 8-5: House Battery Disconnect Switch Location on the back of the DCD board

The house battery disconnect panel (Figure 8-4) is located in the cargo storage area on the driver side. Along with the inverter switch and several breakers, the rotary switch labeled House Battery Master Switch can disconnect the house batteries when the vehicle is in storage for long periods.

Rotating this switch disconnects the house batteries only, not the engine batteries. This feature is designed to disconnect all 12 VDC circuitry from the batteries and prevent them from being drained during storage.



Figure 8-4: House Battery Disconnect Panel Switch

ENGINE BATTERY

DISCONNECT PANEL

The engine battery disconnect panel is located in the outside battery storage compartment, on the rear of the passenger's side of the motor home.

On the upper, right-hand side of that compartment is another rotary switch (Figure 8-6), which, when activated, disconnects the "engine" batteries. When the motor home is to be stored for any length of time, it is wise to disconnect these two 12 VDC systems.

When the motor home is removed from storage, rotate the upper, right-hand disconnect switch to restore the 12 VDC power.

Tiffin Motor homes recommends disconnecting the engine batteries while servicing the coach.

For routine, short-term use, there is a "12 VDC disconnect" switch on the switch console located in the stairwell of the Allegro Bus (Figure 8-7). This switch—located at the bottom of the switch console—can be used to disconnect the "house" battery from most of the 12 VDC circuits in the motor home so that there is no inadvertent drain on the battery while the owner is away from the motor home (e.g., shopping trips, day trips for sightseeing).



Figure 8-7: 12 VDC Disconnect Switch



Figure 8-6: Engine Battery Disconnect Panel Switch

Tiffin Motor homes also recommends periodically checking the fluid levels in the batteries constituting the 12 VDC "house"

ELECTRICAL FEATURES

battery system to make sure that all fluid levels are properly maintained; otherwise, a full charge cannot be maintained in the batteries.

Your motor home is also equipped with a battery maintainer (Figure 8-9) that automatically activates when the motor home is plugged into shore power in order to maintain charge in the engine batteries. If you have “flooded/wet” as shown on page.



Figure 8-8: Battery

KING EXTENDED BOOSTER (OPTIONAL)

The KING Extend boosts and extends personal LTE / Cell signal up to 32x, providing greater coverage and speeds while supporting multiple users. Ideal for RVers, marine enthusiasts, truckers, campers, outdoorsmen, tailgaters, and all mobile adventurers looking for cellular connectivity.



12 VOLT DC (VDC) RECEPTACLES

Your motor home is equipped with a 12 VDC receptacle conveniently located inside of the center console (Figure 8-11). This 12 VDC receptacle can be used for providing power to various items, such as cellular phones, personal computers, or portable communications equipment.

This receptacle is usually found on the bulkhead in front of the passenger’s seat so that it is conveniently available. This receptacle accommodates the “cigarette-lighter” type of connector.



Figure 8-11: 12 VDC Receptacle

USB RECEPTACLES



Figure 8-12: USB Receptacle

The motor home is equipped with USB ports (Figure 8-12) conveniently located on the front dashboard and in the bedroom area as well as on the passenger console. These ports allow for easy access when charging cell phones, laptop computers, iPods, iPads, or tablets.

ELECTRICAL FEATURES

INVERTER

Your motor home is equipped with two 2800 watt Magna Sine Wave Inverter. When the 120 VAC power is not available, either



from the power cord or the generator, the inverter/charger may be used. The control panel for the inverter/charger (Figure 8-13) is integrated into the Spyder multiplex screen in the middle of the coach. One of the inverters can be used to run the front A/C while the Zephyr is moving.



Figure 8-13: Control Panel for the Inverter/Charger

The inverter/charger has two modes of operation: INVERTER (providing power to your appliances from the batteries) and AC (running from shore power or a generator). Whenever the inverter is in AC mode, it passes power directly to your appliances as well as recharges the batteries using a three-stage battery charger (Bulk, Absorption, and Float). This approach to battery charging provides rapid and complete charging cycles without placing undue stress on the batteries. Inverter operation must be enabled on the remote panel.

With search mode enabled, the inverter pulses the AC output looking for an electrical appliance (typically 5 to 100 watts, depending upon the setting you have selected).

When there is no load detected, the inverter automatically goes into search mode (sleep) to minimize energy consumption. During this time, the inverter's green LED flashes (fast) to indicate SEARCH mode. When an appliance is switched on inside the coach, the inverter recognizes the need for power and automatically starts the inverter.

Whenever AC Shore Power is no longer sensed, the inverter automatically transfers to battery power with no interruption to your appliances. The inverter's green LED flashes once every 2 seconds (medium flash) to indicate it is running on battery power and providing AC to the coach.

Whenever AC Shore Power is sensed, the inverter automatically transfers to the shore power with minimal interruption to your appliances.

Whenever the inverter is running on nominal AC shore power, it charges the batteries. The inverter's green LED stays ON (solid) to indicate the first stage of charging. During bulk charging, the charger supplies the maximum amount of constant current to the batteries. As the battery voltage rises to a set value, the charger will then switch to the next charging mode.

As the inverter continues to run on nominal AC Shore Power, and the batteries have been successfully bulk charged, the charger enters its second stage of charging. The inverter's green LED flashes once every second (fast flash) to indicate absorption charging for 1-3 hours depending upon the battery bank selection. The charger then switches to its final mode.

ELECTRICAL FEATURES

As AC shore power continues the inverter's green LED flashes once every 8 seconds (slow flash) to indicate the third and final stage of charging. The batteries are held at the float voltage as long as AC is present at the inverter's input. Float charging reduces battery gassing, minimizes watering requirements (for flooded batteries), and ensures that the batteries are maintained at optimum capacity.

The inverter monitors the AC Shore Power, the batteries and itself. Whenever a condition occurs that is outside the normal operating parameters, the inverter will take the necessary steps to protect your appliances, batteries, or itself from damage. Whenever the battery voltage reaches a low level, the inverter will initiate Low Battery Cut-Off (LBCO), which automatically shuts the inverter down, along with all connected loads, to protect the batteries from over-discharge damage. The inverter's LED turns OFF to indicate the fault condition.

As the inverter is charging, it constantly monitors the batteries. In the event that the battery voltage level becomes too high, it automatically turns off the battery charger to protect the batteries from damage. The inverter's LED turns OFF to indicate the fault condition.

NOTE: High battery voltage might be caused by excessive voltage from the alternator, solar panels, or other external charging sources.

During inverter and AC Shore Power operation, the inverter monitors the AC and DC circuits. In the event of a short-circuit or overload condition, the inverter will shut down. The inverter's LED turns OFF to indicate the fault condition. During inverter operation, if the inverter becomes overheated, it will shut down to protect itself from damage. The inverter's LED turns OFF to indicate the fault condition. For further reading and additional information on the above, reference your inverter/charger manual that will be found in your Owner's Information Package.

120 VOLT (VAC) AC RECEPTACLES

Your motor home is equipped with several 120 VAC receptacles (Figure 8-14) located throughout the interior of the motor home. These 120 VAC receptacles are of the "three-prong" variety; the third prong being a grounding pin that provides adequate grounding to protect one from any electrical shock.

For these receptacles to work properly, do not use an adapter, cheater, or extension cord, which defeats the function of the grounding pin. For the same reason, never remove or bend away the ground prong or pin from any three-prong AC plug so that it would fit a two-prong AC receptacle (i.e., an ungrounded AC receptacle).

Never operate the motor home if there is an electrical short present, as an electrical short might deliver an electrical shock to anyone coming in contact with the exterior of the unit.

If you should feel even the slightest of electrical shock, immediately disconnect the unit from the 120 VAC power source and locate the electrical fault (i.e., typically, it is a break in the grounding circuit).

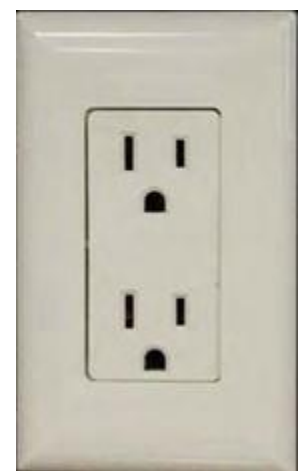

Figure 8-14: 120 VAC Receptacle

ELECTRICAL FEATURES

Do not reconnect the 120 VAC power until after that electrical fault is fixed—the grounding circuit must be continuous from the frame to the distribution panel, to the power cord, and to the earth ground so that electrical-shock protection is realized.

GROUND-FAULT-CIRCUIT-INTERRUPT RECEPTACLES

In the kitchen and bath areas, there are 120 VAC GFCI receptacles (Figure 8-15), which provide greater protection against inadvertent electrical shocks.

These specialized GFCI receptacles provide both overload and short-circuit protection for the user. The electrical receptacles located in the slide-out are wired through the kitchen GFCI. The exterior receptacles are wired through the bathroom GFCI. Consequently, if an appliance plugged into a slide-out or exterior receptacle is not working, check for a tripped GFCI in the kitchen or bathroom.



Figure 8-15: GFCI Receptacle

All GFCI-protected receptacles are marked as such, but only one of them might have two pushbuttons on the receptacle (as shown in the picture). The upper pushbutton is a “test” button, which can be used to ensure that the GFCI function is working.

To reset this GFCI breaker, push the lower button (the “reset” button) to restore power to all the GDCI receptacles on this circuit.

These receptacles protect the user from ground faults between an electrically “hot” wire and ground. The GFCI will not reduce the shock hazard if the short is between a neutral and “hot” wire, or two “hot-load” wires.

The GFCI must be tested at least once a month. The 120 VAC electrical system must be ON for the GFCI to be tested.

To test the GFCI, the reset button must be pushed in fully before starting the test. Push the test button; this will cause the reset button to pop out, which means that the protected circuits have been disconnected. Push the reset button back in until a “click” is heard—this will reactivate the protected circuit. If the GFCI is working properly, the reset button will remain in the “in” position.

ELECTRICAL FEATURES

ELECTRICAL GENERATOR

The Zephyr uses a 12.5 KW electrical generator (Figure 8-16), which is conveniently located by opening the front hood of the motor home.

Before starting or stopping the generator, make sure that all the 120 VAC appliances are turned OFF.

After the generator has been started, wait until the transfer switch has connected before turning ON any of the appliances.

The generator can be started from either the remote-start switch located on the dash or directly at the generator itself. The hour meter installed on the generator records the number of hours of operation of the generator motor—this elapsed time is needed for observing necessary maintenance schedules on the generator.

For more detailed operating instructions and to determine necessary preventive maintenance schedules and procedures, review the manufacturer's owner's manual.



Figure 8-16: Electrical Generator



CAUTION

Failure to turn OFF the 120 VAC appliances when starting or stopping the generator might damage the transfer switch and/or electrical appliances.

ELECTRICAL FEATURES

ENERGY MANAGEMENT SYSTEM

The energy management system (EMS) (Figure 8-17) distributes all the 120 VAC power throughout the motor home, whether it comes from shore power, generator, or the inverter. The EMS monitors the incoming power, and manages the power to reduce circuit breaker tripping. It does this by momentarily shedding power to the loads under its control when the user turns on other more critical appliances in the motor home. EMS restores power when the appliance is turned off. The EMS panel displays the status of incoming power and the controlled loads.

When coupled with an inverter, EMS reduces battery charge rate before shedding any loads. Working together, an inverter assist feature is available. Normally the inverter is at rest when shore power is available. EMS utilizes the inverter and the coach battery bank to smooth out peak load demands. The inverter assist feature scales back the charge rate in order to have more 120 VAC power available for the appliances.



Figure 8-17: Energy Management System

ELECTRICAL POWER CORD REEL

The electric power cord reel (Figure 8-18) enables you to manually extract the power cord reel as needed. To retract the power cord, hold the switch until the power cord is fully retracted.



Figure 8-18:
Electrical Power
Cord Reel

AUTOMATIC TRANSFER SWITCH

The automatic transfer box switches 120V AC power from the shore or generator to the coach's main distribution panel. The transfer box has a delay of around three seconds before switching power to the shore, and a delay of around 30 seconds before switching power to the generator.

If the unit is plugged into the shore but there is no power to the coach, then make sure the shore outlet has power. If power is present, this might indicate that the unit is sensing an open neutral condition.

ELECTRICAL FEATURES

Start the generator; if the power is restored, then the shore plug or the outlet might be defective (the neutral line might be broken).

If there is no power to the coach from the shore or generator, then check the generator circuit breaker. If the circuit breakers are not tripped in the generator or the coach, the transfer box might need to be replaced. For more detailed information on the automatic transfer switch, refer to the specific owner's instructions found in the owner's information package.

	CAUTION
Service to this box must be done by a qualified technician. DO NOT attempt to remove cover unless the shore cord is unplugged and the generator is off.	

NOTICE
Be sure air conditioning units are off before connecting or disconnecting to or from shore power.

FUSE BLOCKS

Some of the electrical circuitry within the motor home is protected by various fusing systems. These fuse blocks protect some of the major electrical systems of immediate concern to the driver.

The electrical circuits protected by the under-dash fuse block include: headlights, panel light for dashboard, taillights, optional jacks, turn signals, cruise control, engine computer, accessory fuses, heater, and dash air conditioning. Additionally, there is another chassis fuse panel that works in conjunction with the chassis fuse panel and provides comparable protection for the above-listed circuits.

ELECTRICAL FEATURES

SEVEN-PIN TOWING CONNECTOR

Your motor home is equipped with a standard, 7 pin connector near the towing hitch at the rear of the motor home to supply the necessary circuitry to control a towed vehicle.

The wiring of that connector is shown in the accompanying diagram (Figure 8-20).

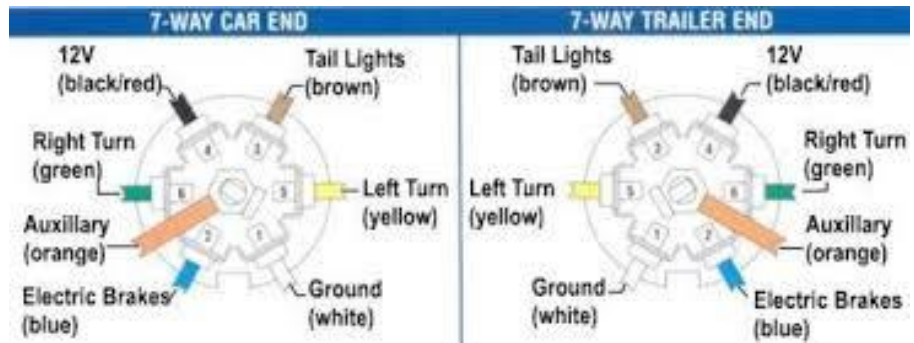

Make sure that any cable from the vehicle to be towed is wired correctly to mate properly with the connections shown in the connector. If in doubt about proper wiring, have a qualified service technician prepare and install the necessary cable to mate with the 7 pin connector on the motor home to ensure proper operation subsequently when any vehicle is actually towed by the motor home.

When the towed vehicle is uncoupled from the motor home and the cable is disconnected from the 7 pin connector, be sure to close the spring-hinged cover plate on the connector to protect the contact pins from dirt or debris. In a similar manner, protect the cable end from similar damage, weather, or debris—one such method could be to place the connector end in a heavy-gauge plastic bag (e.g., polypropylene, polyethylene, etc.) and secure the bag tightly around the cable with a stout elastic band or tape and then mount the secured cable in a manner to keep it both from mechanical damage and water intrusion.

When the towed vehicle is uncoupled from the motor home and the cable is disconnected from the 7 pin connector, be sure to close the spring-hinged cover plate on the connector to protect the contact pins from dirt or debris. In a similar manner, protect the cable end from similar damage, weather, or debris—one such method could be to place the connector end in a heavy-gauge plastic bag (e.g., polypropylene, polyethylene, etc.) and secure the bag tightly around the cable with a stout elastic band or tape and then mount the secured cable in a manner to keep it both from mechanical damage and water intrusion.

ELECTRICAL FEATURES

WIFI ANTENNA (OPTIONAL)

Your motor home might be equipped with a WIFI antenna (Figure 1 or 2) to permit access to local unlocked WIFI signals. You can also purchase data packages from the antenna manufacturers. Please see their manuals or websites for more information. Remember. In amplifying any poor signals, the amplified signal will be minimal.



Figure 2: OpenRoad Mobile

ELECTRICAL FEATURES

ELECTRICAL DIAGRAM (ALL REFERENCES TO 2023 ALSO INLCUDE 2024)

45FZ

Electrical Floor Plan Layout

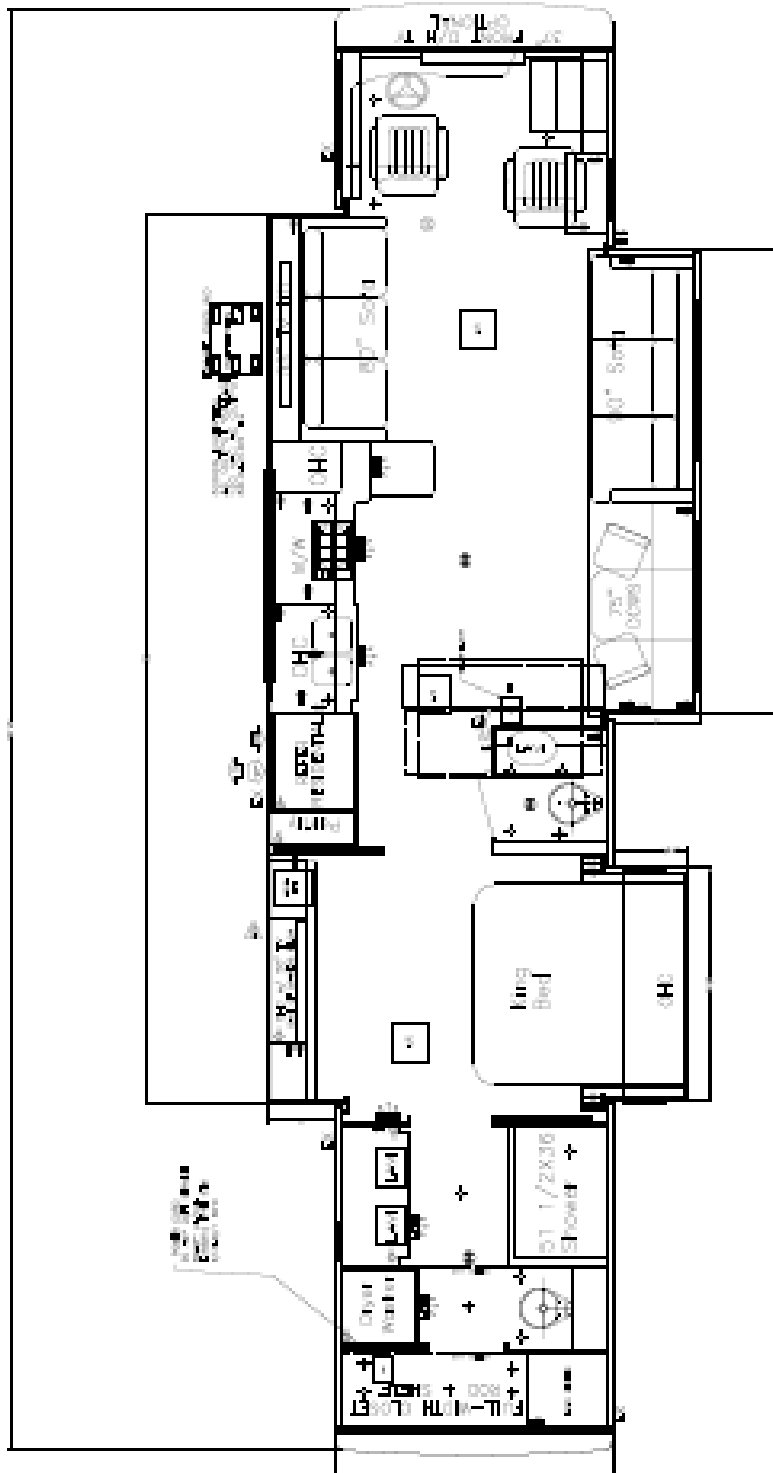

ELECTRICAL FEATURES

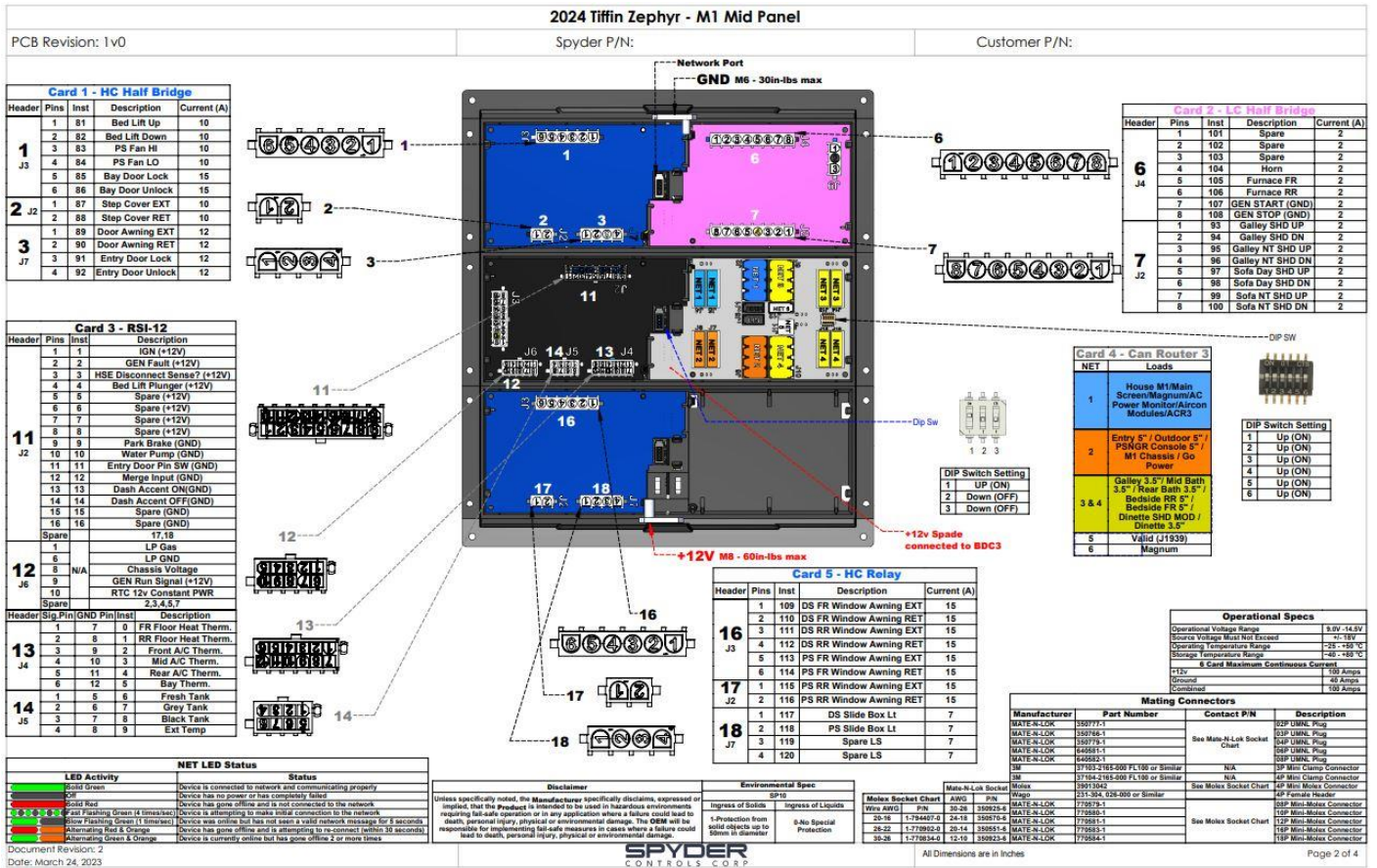

ELECTRICAL FEATURES

2024 Tiffin Zephyr - M1 Rear Panel

PCB Revision: 1v0 Spyder P/N: Customer P/N:

Card 1 - Dimmer

Header	Pins	Inst	Description	Current (A)
1	1		Entry Lt	6
2	2		Bus/Phaeton Only	12
3	3		Bus/Phaeton Only	12
4	4		Bus/Phaeton Only	12
5	5		Bus/Phaeton Only	6
6	6		Dash Accent	6
7	7		Bus/Phaeton Only	12
8	8		Bus/Phaeton Only	6
9	9		DS Slide	6
10	10		PS Slide	6
11	11		FR Courtesy	12
12	12		RR Courtesy	12

Card 2 - Dimmer

Header	Pins	Inst	Description	Current (A)
1	13		Bedroom Ceiling Lt	6
2	14		Bed Accent	12
3	15		FR Accent 1	12
4	16		FR Accent 2	12
5	17		Task Lt	6
6	18		Mid Bath Lt	6
7	19		Mid Bath Vanity Lt	12
8	20		Rear Bath Lt	6
9	21		Rear Bath Vanity Lt	6
10	22		FR Bed Reading	6
11	23		RR Bed Reading	12
12	24		RR Accent	12

Card 3 - Dimmer

Header	Pins	Inst	Description	Current (A)
1	25		TV Accent Lt	6
2	26		Closet Lt	12
3	27		Spare	12
4	28		Spare	12
5	29		Floor HT FR Zone	6
6	30		Floor HT RR Zone	6
7	31		Spare	12
8	32		Fireplace Override	6
9	33		Bus/Phaeton Only	6
10	34		Bus/Phaeton Only	6
11	35		Bus/Phaeton Only	12
12	36		Bus/Phaeton Only	12

Card 4 - Breaker

Header	Pins	Inst	Description	Current (A)
2	37		Basement 12V PWR/EXT TV Lift	20
3	38		SE/ELEVEL	5
6	39		Front Furnace	20
9	40		Prox A/C RLY SW/Galley Motion Lt	5
12	41		Switch/RR Blower	10
15	42		Vent Fan PWR	15
14	43		Rear Furnace	20
13	44		Mid Toilet	10
10	45		FR Pass Slide/Onnetta SHD	10
7	46		USB Bed Slide/Partition Wall USB	20
4	47		Truma Water Heater	8
1	48		FR/RR TV Lift	15

Card 5 - Dimmer

Header	Pins	Inst	Description	Current (A)
1	49		Galley Lt	6
2	50		Galley Accent Lt	12
3	51		DS Crown Accent Lt	12
4	52		PS Crown Accent Lt	12
5	53		Bed Vanity Lt	6
6	54		Foyer Lt	6
7	55		Foyer Accent Lt	12
8	56		FR Bed Valance Accent Lt	6
9	57		RR Bed Valance Accent Lt	6
10	58		Bed Headboard Accent	6
11	59		Hutch/Hall Accent Lt	12
12	60		Hall Lt	12

Card 6 - Dimmer

Header	Pins	Inst	Description	Current (A)
1	61		Mid Bath Courtesy Lt	6
2	62		Living Area Accent Lt	12
3	63		Living Area Lt	12
4	64		Wall Accent Lt	12
5	65		Rear Bath Courtesy Lt	6
6	66		Rear Bath Shower Miser Lt	6
7	67		Rear Bath Accent Lt	12
8	68		DS Main Slide Valance Accent Lt	6
9	69		PS Main Slide Valance Accent Lt	6
10	70		Spare	6
11	71		Spare	12
12	72		Spare	12

Operational Specs

Operational Voltage Range	3.0V - 14.5V
Source Voltage Must Not Exceed	0V - 18V
Operating Temperature Range	-25° - 125° C
Storage Temperature Range	-40° - 150° C
Wires AWG	28-16
Pin	1-24
Card Maximum Continuous Current	100 Amps
Board Maximum Continuous Current	40 Amps
Board Maximum Current	100 Amps

NET LED Status

LED Activity	Status
Solid Green	Device is connected to network and communicating properly
Off	Device has no power or has connectivity issues
Solid Red	Device has gone offline and is not connected to the network
Off and Flashing Green (4 times/sec)	Device is attempting to make initial connection to the network
Off and Flashing Green (1 time/sec)	Device has gone offline and is attempting to re-connect within 30 seconds
Alternating Red & Orange	Device is currently online but has gone offline 2 or more times
Alternating Green & Orange	Device is currently online but has gone offline 2 or more times

Manufacturer **Environmental Spec**

SPIDER	
C O N T R O L S C O R P	
Unless specifically noted, the Manufacturer specifically disclaims, expressed or implied, that the Product is intended to be used in hazardous environments, reporting life-safety operation or in any application where a failure could lead to death, personal injury, physical or environmental damage. The OEM will be responsible for implementing life-safety measures to cases where a failure could lead to death, personal injury, physical or environmental damage.	
E-IP68	
Ingress of Solids	
Ingress of Liquids	
No Special Protection	

Manufacturer **Part Number** **Mating Connectors**

Manufacturer	Part Number	Contact P/N	Description	Mate
MATE-N-LOCK	13076L-1	13076L-1	13P UMK Pin	J8
MATE-N-LOCK	48019-0	48019-0	13P UMK Pin	J9
MATE-N-LOCK	13076L-1	13076L-1	13P UMK Pin	J10
MATE-N-LOCK	13076L-1	13076L-1	13P UMK Pin	J11
MATE-N-LOCK	13076L-1	13076L-1	13P UMK Pin	J12
MATE-N-LOCK	13076L-1	13076L-1	13P UMK Pin	J13
MATE-N-LOCK	13076L-1	13076L-1	13P UMK Pin	J14
MATE-N-LOCK	13076L-1	13076L-1	13P UMK Pin	J15
MATE-N-LOCK	13076L-1	13076L-1	13P UMK Pin	J16
MATE-N-LOCK	13076L-1	13076L-1	13P UMK Pin	J17
MATE-N-LOCK	13076L-1	13076L-1	13P UMK Pin	J18
MATE-N-LOCK	13076L-1	13076L-1	13P UMK Pin	J19
MATE-N-LOCK	13076L-1	13076L-1	13P UMK Pin	J20
MATE-N-LOCK	13076L-1	13076L-1	13P UMK Pin	J21
MATE-N-LOCK	13076L-1	13076L-1	13P UMK Pin	J22
MATE-N-LOCK	13076L-1	13076L-1	13P UMK Pin	J23
MATE-N-LOCK	13076L-1	13076L-1	13P UMK Pin	J24
MATE-N-LOCK	13076L-1	13076L-1	13P UMK Pin	J25
MATE-N-LOCK	13076L-1	13076L-1	13P UMK Pin	J26
MATE-N-LOCK	13076L-1	13076L-1	13P UMK Pin	J27
MATE-N-LOCK	13076L-1	13076L-1	13P UMK Pin	J28
MATE-N-LOCK	13076L-1	13076L-1	13P UMK Pin	J29
MATE-N-LOCK	13076L-1	13076L-1	13P UMK Pin	J30
MATE-N-LOCK	13076L-1	13076L-1	13P UMK Pin	J31
MATE-N-LOCK	13076L-1	13076L-1	13P UMK Pin	J32
MATE-N-LOCK	13076L-1	13076L-1	13P UMK Pin	J33
MATE-N-LOCK	13076L-1	13076L-1	13P UMK Pin	J34
MATE-N-LOCK	13076L-1	13076L-1	13P UMK Pin	J35
MATE-N-LOCK	13076L-1	13076L-1	13P UMK Pin	J36
MATE-N-LOCK	13076L-1	13076L-1	13P UMK Pin	J37
MATE-N-LOCK	13076L-1	13076L-1	13P UMK Pin	J38
MATE-N-LOCK	13076L-1	13076L-1	13P UMK Pin	J39
MATE-N-LOCK	13076L-1	13076L-1	13P UMK Pin	J40
MATE-N-LOCK	13076L-1	13076L-1	13P UMK Pin	J41
MATE-N-LOCK	13076L-1	13076L-1	13P UMK Pin	J42
MATE-N-LOCK	13076L-1	13076L-1	13P UMK Pin	J43
MATE-N-LOCK	13076L-1	13076L-1	13P UMK Pin	J44
MATE-N-LOCK	13076L-1	13076L-1	13P UMK Pin	J45
MATE-N-LOCK	13076L-1	13076L-1	13P UMK Pin	J46
MATE-N-LOCK	13076L-1	13076L-1	13P UMK Pin	J47
MATE-N-LOCK	13076L-1	13076L-1	13P UMK Pin	J48
MATE-N-LOCK	13076L-1	13076L-1	13P UMK Pin	J49
MATE-N-LOCK	13076L-1	13076L-1	13P UMK Pin	J50
MATE-N-LOCK	13076L-1	13076L-1	13P UMK Pin	J51
MATE-N-LOCK	13076L-1	13076L-1	13P UMK Pin	J52
MATE-N-LOCK	13076L-1	13076L-1	13P UMK Pin	J53
MATE-N-LOCK	13076L-1	13076L-1	13P UMK Pin	J54
MATE-N-LOCK	13076L-1	13076L-1	13P UMK Pin	J55
MATE-N-LOCK	13076L-1	13076L-1	13P UMK Pin	J56
MATE-N-LOCK	13076L-1	13076L-1	13P UMK Pin	J57
MATE-N-LOCK	13076L-1	13076L-1	13P UMK Pin	J58
MATE-N-LOCK	13076L-1	13076L-1	13P UMK Pin	J59
MATE-N-LOCK	13076L-1	13076L-1	13P UMK Pin	J60
MATE-N-LOCK	13076L-1	13076L-1	13P UMK Pin	J61
MATE-N-LOCK	13076L-1	13076L-1	13P UMK Pin	J62
MATE-N-LOCK	13076L-1	13076L-1	13P UMK Pin	J63
MATE-N-LOCK	13076L-1	13076L-1	13P UMK Pin	J64
MATE-N-LOCK	13076L-1	13076L-1	13P UMK Pin	J65
MATE-N-LOCK	13076L-1	13076L-1	13P UMK Pin	J66
MATE-N-LOCK	13076L-1	13076L-1	13P UMK Pin	J67
MATE-N-LOCK	13076L-1	13076L-1	13P UMK Pin	J68
MATE-N-LOCK	13076L-1	13076L-1	13P UMK Pin	J69
MATE-N-LOCK	13076L-1	13076L-1	13P UMK Pin	J70
MATE-N-LOCK	13076L-1	13076L-1	13P UMK Pin	J71
MATE-N-LOCK	13076L-1	13076L-1	13P UMK Pin	J72
MATE-N-LOCK	13076L-1	13076L-1	13P UMK Pin	J73
MATE-N-LOCK	13076L-1	13076L-1	13P UMK Pin	J74
MATE-N-LOCK	13076L-1	13076L-1	13P UMK Pin	J75
MATE-N-LOCK	13076L-1	13076L-1	13P UMK Pin	J76
MATE-N-LOCK	13076L-1	13076L-1	13P UMK Pin	J77
MATE-N-LOCK	13076L-1	13076L-1	13P UMK Pin	J78
MATE-N-LOCK	13076L-1	13076L-1	13P UMK Pin	J79
MATE-N-LOCK	13076L-1	13076L-1	13P UMK Pin	J80
MATE-N-LOCK	13076L-1	13076L-1	13P UMK Pin	J81
MATE-N-LOCK	13076L-1	13076L-1	13P UMK Pin	J82
MATE-N-LOCK	13076L-1	13076L-1	13P UMK Pin	J83
MATE-N-LOCK	13076L-1	13076L-1	13P UMK Pin	J84
MATE-N-LOCK	13076L-1	13076L-1	13P UMK Pin	J85
MATE-N-LOCK	13076L-1	13076L-1	13P UMK Pin	J86
MATE-N-LOCK	13076L-1	13076L-1	13P UMK Pin	J87
MATE-N-LOCK	13076L-1	13076L-1	13P UMK Pin	J88
MATE-N-LOCK	13076L-1	13076L-1	13P UMK Pin	J89
MATE-N-LOCK	13076L-1	13076L-1	13P UMK Pin	J90
MATE-N-LOCK	13076L-1	13076L-1	13P UMK Pin	J91
MATE-N-LOCK	13076L-1	13076L-1	13P UMK Pin	J92
MATE-N-LOCK	13076L-1	13076L-1	13P UMK Pin	J93
MATE-N-LOCK	13076L-1	13076L-1	13P UMK Pin	J94
MATE-N-LOCK	13076L-1	13076L-1	13P UMK Pin	J95
MATE-N-LOCK	13076L-1	13076L-1	13P UMK Pin	J96
MATE-N-LOCK	13076L-1	13076L-1	13P UMK Pin	J97
MATE-N-LOCK	13076L-1	13076L-1	13P UMK Pin	J98
MATE-N-LOCK	13076L-1	13076L-1	13P UMK Pin	J99
MATE-N-LOCK	13076L-1	13076L-1	13P UMK Pin	J100

Document Revision: 2 **Date:** March 24, 2023

Page 3 of 4

ELECTRICAL FEATURES

Transfer Box

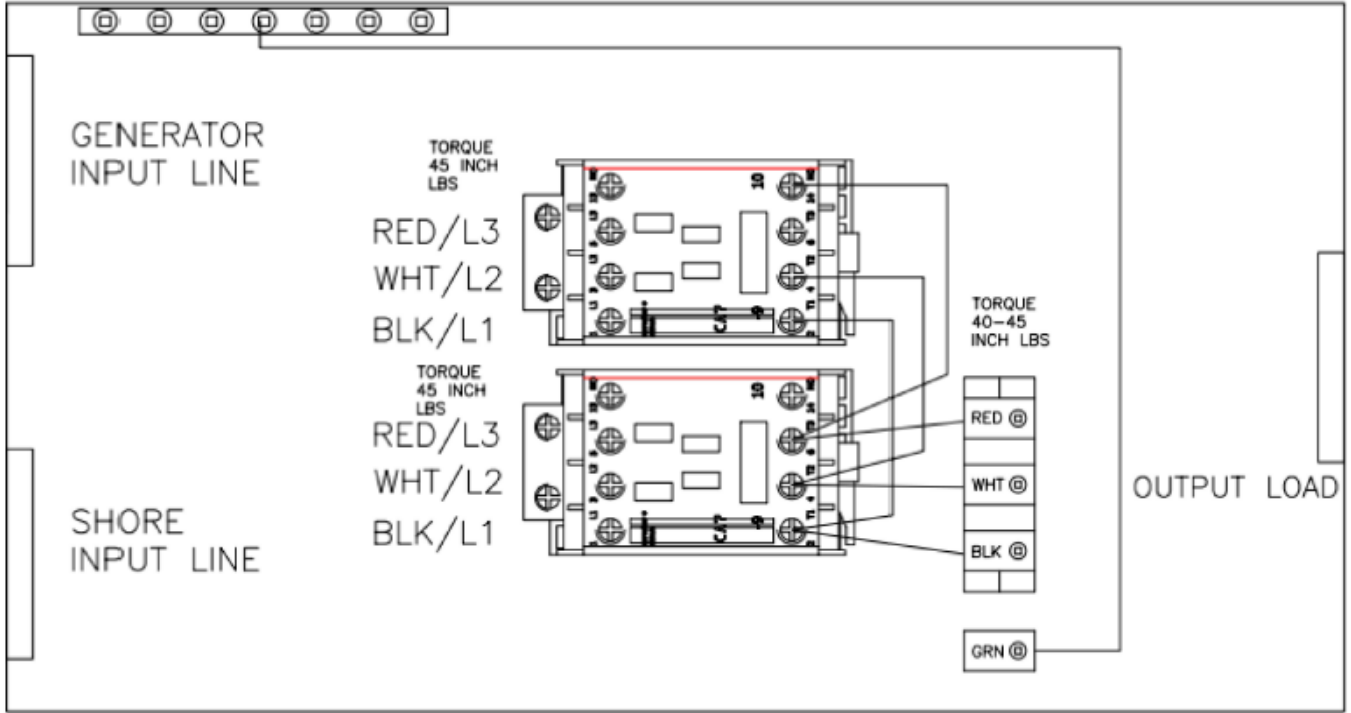

2024 Tiffin Zephyr - M1 Front Panel

PCB Revision: 1v0 Spyder P/N: Customer P/N:

Card 1 - Slide Card

Header	Pins	Inst	Description	Current (A)
1	1		Awning Constant	7
1	2		Undercoath Constant	7
3	3		Slideout Breaker #1	20
4	4		Slideout Breaker #2	20
2	1	N/A	Ignition (+12V)	N/A
2	2		Park Brake (GND)	N/A
3	1	161	PIS FR Slide Ret	7
3	2	162	PIS FR Slide Ret	7
3	3	163	DIS FR Slide Ext	7
4	1	164	DIS FR Slide Ret	7
4	2	165	PIS RR Slide Ext	7
4	3	166	PIS RR Slide Ret	7
4	4	167	DIS RR Slide Ret	7
4	5	168	DIS RR Slide Ret	7
4	6	169	Hydraulic Pump	7
4	7	170	Spare	7

Card 2 - HC Half Bridge

Header	Pins	Inst	Description	Current (A)
1	1	171	Windshield Accent	7
3	3	172	Water Pump	10
3	4	173	Headlights	7
4	4	174	Door/Assist handle	7
5	5	175	Bus/Pneumat Only	7
6	6	176	U-Coach	7
7	7	177	Awning Lt	7
7	8	178	Road Lt	7
7	9	179	Porch Lt	7
8	1	180	Map	7
8	3	181	Spare LS	7
8	4	182	Spare LS	7

Card 3 - Breaker

Header	Pins	Inst	Description	Current (A)
2	1	183	Camera/Radio (IGN)	5
3	1	184	Jack Buzzer (IGN)	5
6	1	185	CB/Satellite	10
9	1	186	Panel Lamp/Head Lt (IGN)	5
12	1	187	12V Outlet 1/USB PWR	20
15	1	188	HCR11 PWR	5
14	1	189	Fantry (IGN)	5
13	1	190	TV Relay/Fridge/Dash SHD (IGN)	5
10	1	191	HVAC Denso (IGN)	10
7	1	192	Dock Light	15
4	1	193	Entry Step SW	5
1	1	194	Dash USB PS USB PWR	20
1	1	N/A	IGN (+12V)	N/A
2	2	N/A	N/A	N/A

Card 4 - Breaker

Header	Pins	Inst	Description	Current (A)
2	1	195	12V Outlet 2/USB PWR	20
3	1	196	Engine Preheat SW	5
6	1	197	Elect Step Cover	15
9	1	198	Power Window (IGN)	15
12	1	199	DIS Mirror PWR (IGN)	5
15	1	200	PIS Mirror PWR (IGN)	5
14	1	201	Seat Power #1	25
13	1	202	Seat Power #2	25
10	1	203	Dash Shade Mod	10
7	1	204	Map Lt/Fans/Radio	10
4	1	205	Radio Mem/XM PWR	15
1	1	206	HVAC Denso	15
1	1	N/A	IGN (+12V)	N/A
2	2	N/A	N/A	N/A

NET LED Status

LED Activity	Status
Off	Device is disconnected to network and communicating properly
Steady Green	Device has no power or has connectivity issue
Flashing Red	Device has gone offline and is not connected to the network
Flashing Green (5 times)	Device is attempting to make initial connection to the network
Flashing Green (10 times)	Device was online but has not seen a valid network message for 3 seconds
Flashing Red & Green	Device has gone offline and is attempting to re-connect within 30 seconds
Steady Green & Orange	Device is currently online but has gone offline 2 or more times

Operational Specs

Operational Voltage Range	0.9V -14.5V
Maximum Voltage With Net Connected	<= 15V
Operating Temperature Range	23 -100 °F
Storage Temperature Range	23 -100 °C
4 Card Maximum Continuous Current	48 Amps
1 Card Maximum Continuous Current	10 Amps

Disclaimer

Warranty is void if the product is used in an application where a failure could lead to death, personal injury, physical or environmental damage. The OEM will be responsible for implementing fail-safe measures in cases where a failure could lead to death, personal injury, physical or environmental damage.

Environmental Spec

Spec	Value
AVD	1 PPS
Progress of Solids	30-21
Moisture Protection	20-14
Shock Protection	12-10

Manufacturers / Part Number

Manufacturer	Part Number
WATERLOO	30977-1
WATERLOO	30978-1
WATERLOO	30979-1
WATERLOO	30980-1
WATERLOO	30981-1
WATERLOO	30982-1
WATERLOO	30983-1
WATERLOO	30984-1
WATERLOO	30985-1
WATERLOO	30986-1
WATERLOO	30987-1
WATERLOO	30988-1
WATERLOO	30989-1
WATERLOO	30990-1
WATERLOO	30991-1
WATERLOO	30992-1
WATERLOO	30993-1
WATERLOO	30994-1
WATERLOO	30995-1
WATERLOO	30996-1
WATERLOO	30997-1
WATERLOO	30998-1
WATERLOO	30999-1
WATERLOO	31000-1

Mating Connectors

Contact PIN	Description
1	IGN (+12V)
2	IGN (+12V)
3	IGN (+12V)
4	IGN (+12V)
5	IGN (+12V)
6	IGN (+12V)
7	IGN (+12V)
8	IGN (+12V)
9	IGN (+12V)
10	IGN (+12V)
11	IGN (+12V)
12	IGN (+12V)
13	IGN (+12V)
14	IGN (+12V)
15	IGN (+12V)
16	IGN (+12V)
17	IGN (+12V)
18	IGN (+12V)
19	IGN (+12V)
20	IGN (+12V)

ELECTRICAL FEATURES

Aqua Hot Assembly

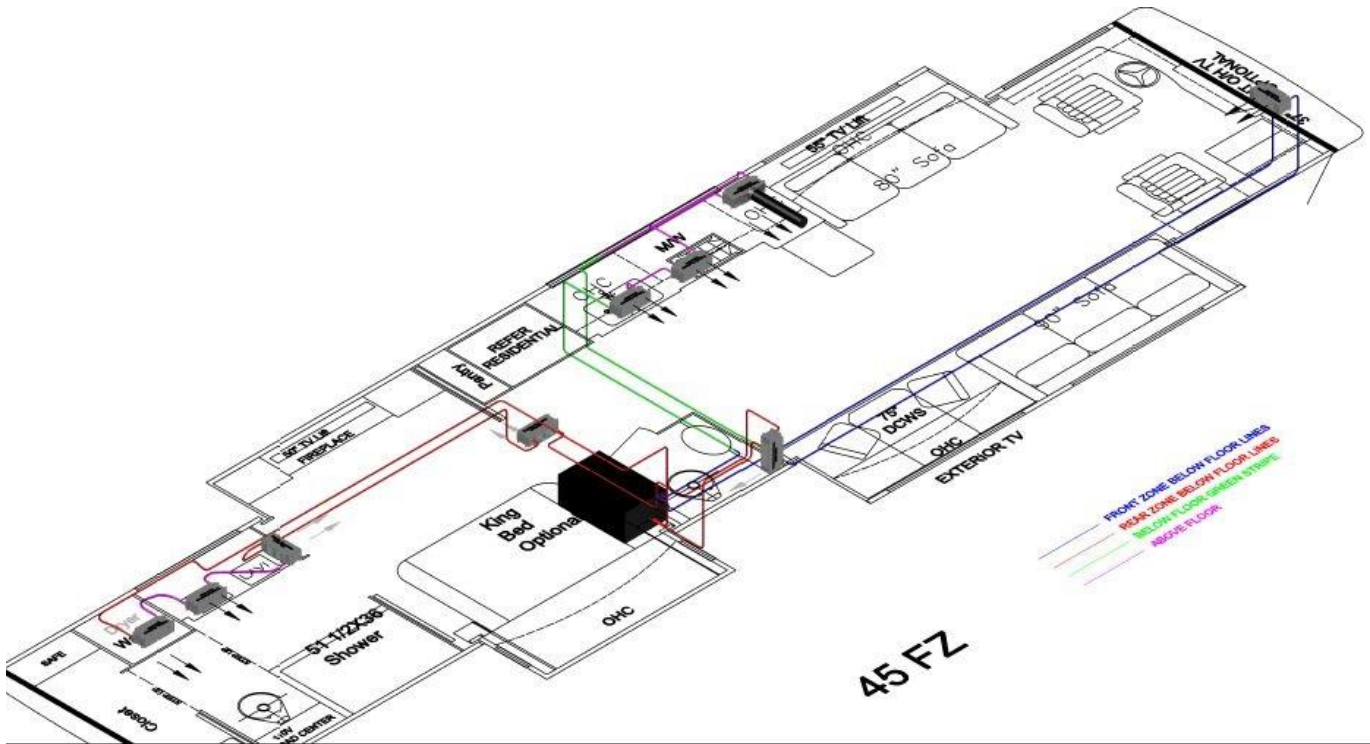

ELECTRICAL FEATURES

Aqua Hot Flow Schematic

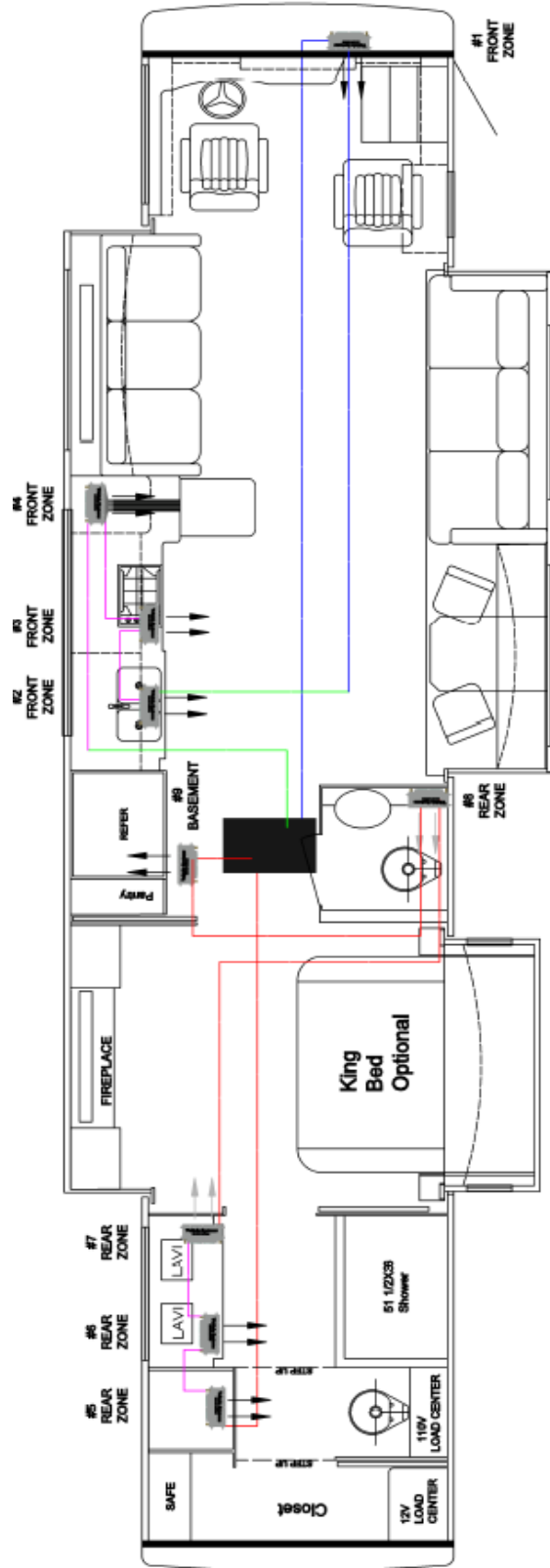

ZEPHYR

SLIDE-OUT FEATURES

Chapter

9

SLIDE-OUT FEATURES

SLIDE-OUT OVERVIEW



CAUTION

BEFORE ACTIVATING THE SLIDE-OUT FEATURES, read the slide-out instruction manual first. The motor home must be parked, the ignition switch must be in the ON position and the leveling jacks must be used to level the motor home **PRIOR** to activating the slide-out features. The emergency foot brake and parking brake must be engaged. Be sure the front driver's seat is moved forward before opening the slide-out.

GENERAL CONSIDERATIONS

NOTICE

The slide-out room requires semi-annual inspection to ensure that the slide-out mechanism is properly aligned and functioning correctly. Make sure that this inspection is performed every six months to correct any possible misalignments.

The slide-out-room feature is actuated by a screen on the Spyder Controls System (the third button down on the left of the control) (Figure 9-1). The switch must be manually held down in the desired position (either IN or OUT) to activate the desired action of the slide-out room and continue to be held down until the desired action is concluded.

SLIDE-OUT FEATURES

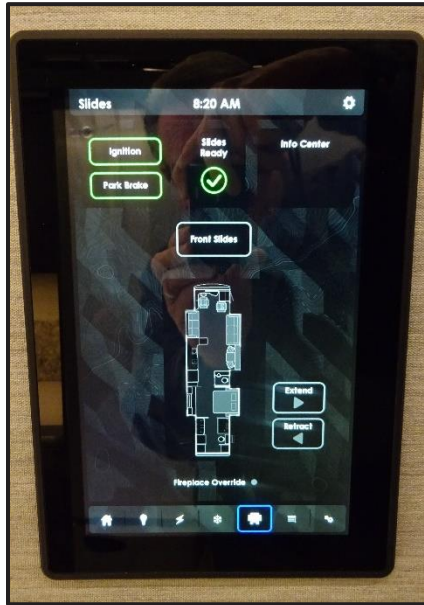

Figure 9-1: Slide-Out Screen on the Spyder Controls System

Switches to operate the front slide-out rooms are also located on the driver's and passenger's seats (Figure 9-2).



Figure 9-2: Slide-Out Switch on Driver and Passenger Seats

NOTE: Releasing the switch before the slide-out is fully extended or retracted will stop the slide-out.

OPERATING PRECAUTIONS

Before the slide-out-room mechanism is used, make sure the motor home is parked, and the leveling process has been properly completed. Verify that no obstacles (branches, trees, telephone poles, power/water hookups, trash bins, etc.), are within a five-foot space envelope of that slide-out room, to keep from damaging the slide-out room when it is finally deployed.

NOTICE

Before attempting to extend the slide-out room, check outside and make sure that there is at least a five-foot clearance around the area where the slide-out room will be extended, and be sure the driver's and passenger's seats are moved to the forward position.

SLIDE-OUT FEATURES

EXTENDING THE SLIDE-OUT ROOM

Any loose materials or possible obstructions, such as rugs or furniture should be removed from the immediate, slide-out room area.

Make sure that the motor home (Figure 9-3) has been leveled, that the battery is fully charged and connected to the electrical system, and that the ignition switch is ON and the engine is running before attempting to use the slide-out features.



Figure 9-3: Extend and Retract Slide-Out Room

Verify that there are no obstructions outside, which might interfere with the operation of the slide-out room.

Before moving the slide-out room in either direction, make sure that the driver's and passenger's chairs are moved forward into the driving area as far as possible and locked into position.

Make sure the parking brake is engaged.

Push EXTEND on the Spyder Controls System, and allow the slide-out room to go to its fully extended position. When fully extended, release the switch.

NOTE: The front slide-outs can also be operated by pressing the buttons located on the sides of the seats.

RETRACTING THE SLIDE-OUT ROOM

Before attempting to move the motor home, the slide-out room must be fully retracted.

Verify that the 12 VDC system is fully charged and connected to the electrical system.

Make sure all personal equipment and any children are away from the slide-out.

Make sure all cabinet doors around the slide-out areas are closed.

Push RETRACT on the Spyder Controls System, and allow the slide-out room to go to its fully retracted position.

NOTE: The front slide-outs can also be operated by pressing the buttons located on the sides of the seats.

Release the switch (this locks the room into position).

SLIDE-OUT FEATURES

NOTICE

If the slide-out room does not move when the switch is depressed, check the following:

- Make sure the ignition system is turned ON.
- Make sure the park brake is engaged.
- Make sure the battery is fully charged and connected.
- Make sure the slide-out breakers haven't been "tripped." These are located in the storage box with the inverter or converter.
- Make sure the power bed is in the UP position before retracting bedroom or vanity slide. Slides will not retract with the power bed in the DOWN position.

SLIDE-OUT FEATURES

EMERGENCY SLIDE-OUT ROOM CONTROL OVERRIDE

If the switches for the slide-out rooms become disabled in the cabin of the motor home, use the emergency override button for all slide-outs (Figure 9-4) that is located in the front driver's side compartment with the fuses for the motor home. This override switch operates all slide-outs simultaneously. To retract or extend the slide-outs, a round dowel or cylinder (for example: barrel of a ballpoint pen) must be inserted in the holes marked RET or EXT.



Figure 9-4: Location of Slide-Out Room Control Override

ZEPHYR

EXTERIOR FEATURES

Chapter

10

EXTERIOR FEATURES

TOWING HITCH

On the rear of the Zephyr is a 20,000-pound towing hitch (Figure 10-1) capable of handling a tongue weight of 1,500 lbs.

This hitch is installed for towing a passenger car to be used when the vehicle is parked. The wire connector installed with this hitch is a standard, 7-pin connector.

A tow brake air outlet for the AirForce One tow brake system is located close to the hitch. Please refer to enclosed manufacture's manual.



Figure 10-1: Towing Hitch

EXTERIOR SIDES



Figure 10-2: Exterior Sides

The sides of your motor home (Figure 10-2) and the end caps are made of gel-coated fiberglass.

To clean these fiberglass surfaces, use only warm water and a mild cleanser; gently wash with soft cloths.

Use of stiff bristle brushes or other harsh abrasives might cause scratches on the fiberglass surfaces.

NOTE: Tiffin Motor homes is NOT responsible for the weathering and/or oxidation of gel-coated surfaces.

Spacious storage compartments are located on the exterior sides of your motor home. These external compartments provide ample additional space for your belongings while you are traveling. When stowing materials in these storage compartments, try to “balance” the resultant weight load from front to rear and from side-to-side. This will keep the center of gravity of the motor home essentially unchanged and should not adversely affect the handling characteristics of the motor home when it is in motion.

EXTERNAL SOLAR PORT

Your motor home is equipped with an external Solar Port located in the water bay. It allows you to plug in your own solar panel. The port is designed to handle a maximum of twenty (20) amps. Your solar panel

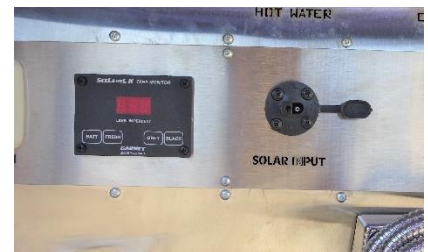

EXTERIOR FEATURES

MUST have its own controller. Tiffin Motor homes is not responsible for the improper use of the External Solar Port.



Figure 10-3: Electric Slide Tray in Cargo Bay (Extended)



Figure 10-4: Electric Slide Tray Switch on Cargo Door

NOTE: The electric slide tray can also be operated from the controls on the driver and passenger side of the coach (Figure 10-5).



Figure 10-5: Zephyr Control

EXTERIOR FEATURES

SECURITY LIGHTS

On the motor home, exterior security lights (Figure 10-6) are standard features.

A light is installed on the passenger side of the coach to help light that side of the Zephyr for added protection.



Figure 10-6: Exterior Security Light

This light can serve as a “porch light” when the motor home is parked and the awning is deployed so that various activities (e.g., sitting outside, grilling, visiting) at dusk and later can be enjoyed by the motor home owners and their guests.

ROOF

The Zephyr is manufactured with a fiberglass roof.

Proper care and routine maintenance of your roof will ensure many years of trouble-free performance.



ELECTRIC STEPS

The Zephyr is equipped with electric doorsteps.

The switch to operate these steps is located in the door stairwell. When the power switch for the steps is in the ON position, open the door and the steps will automatically extend.

For using the electrical, double-entrance, doorsteps:

With the step switch turned ON:

- Close the door. The step should retract and lock into the UP position.
- Open the door. The step should retract and lock into the DOWN position.
- Turn the vehicle ignition switch OFF and open the door. The step will extend and lock in the DOWN position.

With the step switch turned OFF:

- The step should remain in an extended position when the door is closed. Turning OFF the power

EXTERIOR FEATURES

with the step retracted will hold the step in a retracted position, as well.

- With the step extended, close the entrance door. Turn the vehicle ignition switch ON. The ignition override system will go into effect and the step will automatically retract.

NOTE: This feature is operational only the first time the door is opened after the vehicle ignition switch is turned OFF. When the ignition switch is ON, the step will always activate with the door movement, regardless of the position of the step power switch.

Other exterior features include power-assisted awnings (patio awning, door awning, or both). They can be controlled from the Spyder Control Panel.

EXTERIOR FEATURES



CAUTION

DO NOT travel with the steps or awnings in the extended position. If the motor home is driven with the steps or awnings in the extended position, there is the possibility of causing major damage to the steps or awnings, and to the motor home.

NOTICE

If the door is opened and closed without allowing the step to extend fully and lock in the DOWN position, the step will retract and lock in the UP position. When the door is re-opened, the step will not extend. The power switch must be turned ON for the step to extend.



CAUTION

Always be sure to “look before you leap!” When opening the entrance door from the inside, be sure that the step has fully deployed before trying to step outside to avoid falling and possible injury.

EXTERIOR FEATURES

MIRRORS



This motor home is equipped with remote-controlled, exterior, rear-view mirrors.

Always adjust the mirrors for maximum rear visibility prior to driving. If another driver is to drive, be sure the mirrors are readjusted to accommodate the second driver.

The mirrors are adjusted by using the multi-directional switch (Figure 10-7) located on the dashboard. Select the mirror to be adjusted by pointing the arrow in the direction of that mirror.



Figure 10-7: Mirror Adjustment Controls

EXTERIOR FEATURES

Move the control in the direction of movement desired to obtain the best view for that mirror. The adjustment control moves the top half of both mirrors. **The bottom half of each mirror is convex and is adjusted manually.**

Detailed instructions for these manual adjustments can be found in the manufacturer's literature available in the Owner's Information Package. However, this brief overview of mirror adjustment can begin the process: The top portion of the mirror should be adjusted horizontally so that you can see your own motor home in the one-inch surface closest to the motor home. The remaining portion of the mirror now enables you to see the road behind you. The mirror should be adjusted vertically so that you can see the rear bumper on the bottom of the plane portion of the mirror.

The convex mirrors should be adjusted horizontally so that you can see your own motor home in 1/3rd of the mirror. These convex mirrors should then be adjusted vertically to allow you to see any other vehicles alongside your motor home.

These mirrors also contain heating elements to defog or de-ice the mirror glass during cold weather operation. The red ON/OFF switch for this feature is located by the adjustment control. Further adjustment of the mirror might be necessary at the swivel portion of the mirror arm.

NOTICE

Objects viewed in convex mirrors appear smaller and farther away than they actually are.

ZEPHYR

INTERIOR FEATURES

Chapter

11

INTERIOR FEATURES

BEDSPREAD

As a furnished part of the bedroom suite, a bedspread with matching pillow accessories (Figure 11-1) is included with the motor home.

The bedspread and pillow shams are “for dry-cleaning only.” As the bedspread was made with materials treated for stain resistance, dry-cleaning will prolong the life of these materials. The curtains in the bedroom are color-coordinated with the bedspread and accessories to provide a pleasing décor for the bedroom area.



Figure 11-1: Bedroom Décor

FLOORING



Figure 11-2: Typical Flooring
in the Zephyr

Porcelain ceramic tile (Figure 11-2) is standard throughout the motor home with the exception of the slide-out rooms, and the bedrooms, which are carpeted. For routine cleaning, sweeping or vacuuming the floor would be sufficient. If more thorough cleaning is warranted, the flooring can be cleaned with a damp mop and water. For more stubborn stains, a mixture of soap-free household cleaner (e.g., vinegar, ammonia, or comparable products) and water can be used.

Do not saturate the floor surfaces with water, as this could damage the flooring substrate. Do not use any abrasives (cleansers, scouring pads; and the like) as they can scratch or mar the flooring surfaces and might cause damage to the flooring.

INTERIOR FEATURES

HEATED TILE FLOOR

Your Zephyr is equipped with heated tile floor. The heated tile floor does not heat the air but gently warms the surrounding surfaces and occupants, allowing for a lower thermostat setting than traditional heating methods while providing the same comfort level.

Peak floor temperature is 25-30 degrees above ambient floor temperature.

The system uses a controller (Figure 11-3) that regulates the floor temperature by means of a sensor built into the floor, thus ensuring that the temperature sensed by the controller and the owner are the same. The heated tile floor provides clean, quiet heat, with no blowers or transformers, and it creates no hum or noise. The thermostat makes a quiet clicking as it switches on.

For further operating instructions, refer to the manufacturer's literature in the Owner's Information Package.



Figure 11-3: Heated Tile Floor Controller

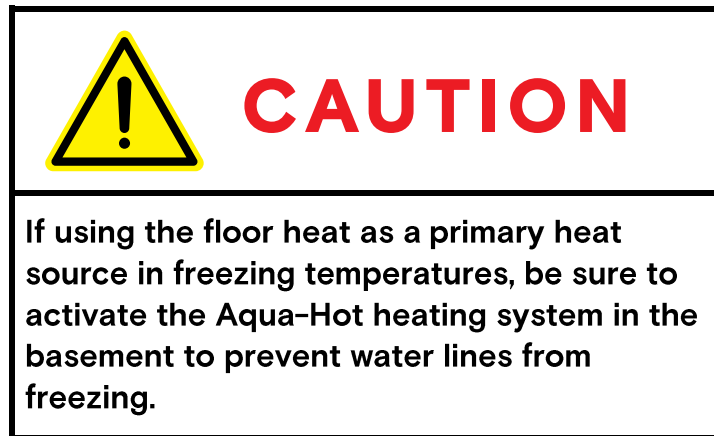

CEILING



Figure 11-4: Ceiling

The ceiling (Figure 11-4) in the motor home is covered with a padded-vinyl headliner, which can be easily cleaned with a damp, soft cloth, and a mild detergent.

Clean around all vent areas to prevent any build-up of dirt, grease, or other accumulations.

INTERIOR FEATURES

WINDOW TREATMENTS

Throughout the Zephyr, the window treatments consist of two shades—solar and blackout (Figure 11-6).

The solar shade allows one to see out during the daytime, yet blocks most of the sunlight and heat from entering the motor home. The blackout shade creates complete privacy for nighttime.

The shades are located on all the windows in the living area and the bedroom, as well as in the cockpit.

The shades can be controlled by using the automatic control switches in the Spyder Control Panel



Figure 11-6: Day/Night Window Shades

MULTIPLEX LIGHTING CONTROL

The multiplex system (Figure 8-10) enables you to control circuits from multiple locations in the coach. Each switch enables you to turn a circuit ON or OFF with individual button presses, and provides an indicator light to determine the status of the circuit (ON or OFF). Many of the circuits are also dimmable by holding the button to dim up or down.

Additional features of the multiplex system include the following:



Figure 11-7: Load Center

- **Master Feature** (this is only on the control panel located at the entrance door) — Enables you to turn all lighting circuits ON or OFF by pressing a single button labeled Light Master. Pressing the Light Master OFF switch will turn off all the interior lights within the coach. Momentarily pressing the Light Master ON switch will turn on the same circuits that were on when the Light Master OFF switch was pressed. Light Master OFF remembers which lights were on when the switch was pressed and will turn those same lights back on when the Light Master ON switch is momentarily pressed. Holding the Light Master ON switch will turn on all interior light circuits.
- **Switch Panel Backlighting** — All of the switches are backlit to make the labels easy to read. If you desire to turn the panel lights off, a switch is conveniently located at the center of the coach labeled Panel Lights, which enables you to turn the back lighting ON, OFF, or DIM.
- **Status LED Indicator** — A green LED beside each switch indicates whether the load is on or off. In some cases, certain switches such as Awnings, Compartment Locks, and Generator do not have a status indicator at the switch.
- **Dimming Circuits** — Certain circuits within the coach are dimmable. To dim a light down, hold the OFF switch until the light is at the desired level, and release the switch. This setting will be remembered the next time the circuit is turned ON. To adjust the light up, hold the ON switch until the light is at the desired level, and release the switch.

INTERIOR FEATURES

SAFE

The Zephyr contains a safe (Figure 11-8). This safe can be used to hold valuables, important documents, and other items you might want to protect during your travels. The safe is located in the rear bedroom closet.



Figure 11-8: Safe

REAR FIREPLACE

To operate the rear fireplace (Figure 11-9), Fireplace Enabled must have a green light on the Slides tab. The slide box containing the fireplace must be fully extended to operate the fireplace.

NOTE: If the fireplace is on and the slide containing the fireplace is retracted even for a second, the fireplace will deactivate, and Fireplace Enabled will cease to have a green light on the Slides tab. To return the functionality of the fireplace, fully extend the slide-out, and turn the fireplace back on.

NOTE: The fireplace will not automatically turn back on if the slide is moved. Once Fireplace Enabled has a green light, the fireplace must be turned back on for operation.



Figure 11-9: Rear Fireplace

ZEPHYR

PLUMBING & BATH FEATURES

Chapter

12

PLUMBING & BATH FEATURES

FRESHWATER SYSTEM

TANK-LEVEL MONITOR

The tank-level monitor (Figure 12-1) enables checking the approximate levels in the fresh, gray, and black-water holding tanks using the level monitors.

The tank-level monitor is located on the 10" touch panel in the hallway.

To use this monitor, press the LEVEL TEST button, and read the fresh, gray, and black-water tank levels.

The “empty” indicator light will momentarily light when the button is pressed. If the tank is full, all of the lights will be ON. Lights are sequentially arranged to indicate fluid levels in approximately third-tank increments. For example, if the tank selected is approximately two-thirds full, then the indicator lights “E” (for “empty”), “1/3,” and “2/3” will be lit.

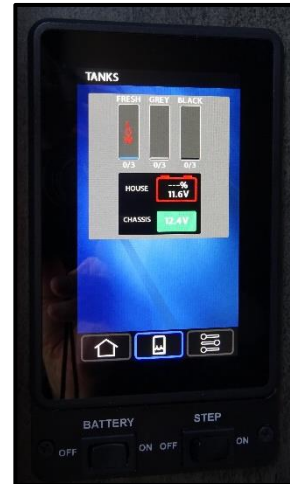

Figure 12-1: Tank-Level Monitor

NOTE: The battery voltage display for the chassis and house battery banks are available on the same screen.

KITCHEN SINK AND INSTANT HOT WATER

The kitchen sink (Figure 12-2) is a single farmhouse sink equipped with a sink cover to provide additional counter space when the sink is not in use.

Wash the sink only with mild detergents and water and use a soft cloth for subsequent drying and polishing.

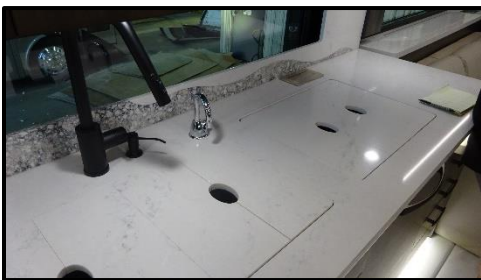

Figure 12-2: Kitchen Sink

The way the InSinkErator® instant hot water system works is really quite simple. First, the system taps into the kitchen sink’s cold water supply, which is connected to the hot water tank. The tank mounts under the sink and keeps 2/3 gallons of water at near-boiling temperatures at all times. The dial at the tank should be set to the lowest setting and adjusted to the



desired temperature. As hot water is used from the faucet, it’s replaced in the tank by cool water, which is quickly heated. A thermostat monitors the water temperature and controls the heating element.

PLUMBING & BATH FEATURES

BATHROOM SINK, SHOWER, & ACCESSORIES

The shower (Figure 12-3 in the bathroom is a solid, continuous surface.

Both vanity sinks are made of glass (Figure 12-4).

Use fiberglass cleaning or mild cleaning supplies to avoid scratching the surfaces.



Figure 12-3: Bathroom Shower

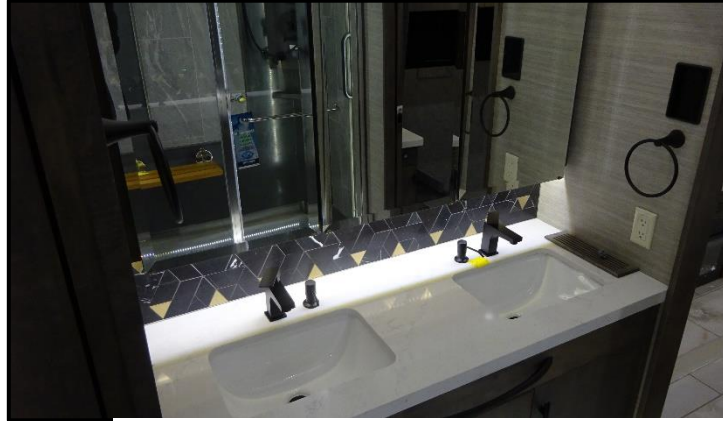

Figure 12-4: Bathroom Sink

WATER PUMP

The water pump is self-priming and totally automatic, operating on demand whenever water is required. The water pump is used to pressurize the freshwater system when the unit is not connected to city water. The switches are located in various conveniently located areas throughout the motor home where water is accessible.

To start the pump:

Fill or partially fill the fresh water supply tank.

Open the kitchen and bathroom faucets.

Turn the water pump switch to ON and allow the water to fill to the water line and the hot water heater.

Close each faucet after it delivers a steady stream of water (close the cold-water faucet first).

Leave the hot water faucets ON until they also deliver a steady stream of water. This procedure will ensure that the water heater is filled with water.

The water pump should stop running once all faucets are closed. The water pump is now ready for automatic operation. The pump will run when a faucet is open and stop when a faucet is closed.

PLUMBING & BATH FEATURES

NOTICE

Never allow the pump to run for long periods of time without water being present in the supply tank, as doing so might cause physical damage or blow fuses.

If water does not flow when a faucet is turned ON while using the demand system, use the following troubleshooting chart:

SITUATION	SOLUTION
Pump running – no water	<ul style="list-style-type: none">• Fill Tank• Clear the water line to the pump
Pump does not run	<ul style="list-style-type: none">• Check the pump switch• Check the 12 volt fuses• Check the electrical connections• Check the battery

All the water should be drained from the freshwater system when the unit is not in use for extended periods. For more detailed information regarding the water pump, refer to the water pump manufacturer's brochure in your motor home Owner's Information Package.

CITY WATER CONNECTION



Figure 12-6: Motor home Water Hose

When connecting your unit to city water, use the water hose (Figure 12-6) manufactured and labeled for potable water service—this will ensure that the hose selected for use will not alter the taste of the water.

To connect the city water supply (Figure 12-7), connect one end of the hose to the city water supply.

Turn the city water supply ON for a few seconds to clear the line. Once the hose has been flushed, turn the supply OFF. Connect the other end of the hose to the city-water connections on the motor home.

Once the city water fill valve is opened, water is supplied to the freshwater system including the hot water heater, faucets, and toilet. Turn ON the water supply and open all of the faucets to clear any trapped air within the plumbing lines within the motor home.



Figure 12-7: City Water Supply Connection

PLUMBING & BATH FEATURES

Once any air pockets have purged from the water lines and water flows freely, close all of the faucets. The city water supply is pressurized; therefore, the water pump is not needed when the water system of the vehicle is connected to the city water system.

NOTE: If city water pressure is more than 60 psi, Tiffin Motor homes recommends that you to use a water pressure regulator to prevent damage to the motor home.

FILLING THE FRESHWATER TANK

The freshwater tank is normally filled from the city water connection. The yellow handle city water/tank fill valve determines whether the city water is going through the water system or into the freshwater tank. Since there is no automatic shut-off when filling the freshwater tank, check the level from the monitor panel while filling the freshwater tank on the motor home.

The excess water will be vented from an overflow in the vent pipe onto the ground when the capacity of that tank has been reached. This pipe is installed in the freshwater tank to prevent possible tank rupture from inadvertent overfilling.

All of the water must be drained from the freshwater system when the motor home is not in use for an extended period.

WATER FILTER

This unit is equipped with a water filter (Figure 12-8), which must be removed before disinfecting the fresh-water system.



Figure 12-8:
Water Filter

First, remove the water filter and then replace cover to allow the sanitizing solution access to the faucets. As installed, the filter will remove chlorine, dirt, and other matter. The filter will also eliminate most phenol (or similar) odors and tastes while delivering sparkling, taste-free water for drinking and cooking.

The water filter is located in the sanitation compartment on the outside of the motor home. The water filter is not guaranteed to remove the tastes and odors of iron and sulfur. To remove these impurities, you need to chlorinate the water. Replacement filters are available that will filter iron and sulfur. Ask your dealer or RV supply center about purchasing an iron and sulfur filter.

If you are traveling in an area where the water has high iron and sulfur content, add one tablespoon of chlorine bleach to every 10 gallons of water in your tank—this will precipitate the iron or sulfur so that the filter can remove those impurities.

If you are at a site where the unit is connected to a city water supply, you will not be able to chlorinate the system because the water flows straight to your faucets and not through the freshwater tank.

Filters should be changed every 6-12 months depending on the quality and quantity of water that is used in your motor home.

PLUMBING & BATH FEATURES

FRESHWATER LINES

Check all of the plumbing connections for leaks at least on an annual basis.

If the water pump runs when all faucets are turned OFF, check for a possible leak. Be sure that the drain valves are closed. Connections at the kitchen and bathroom faucets normally seal by hand tightening them and then making an additional half-turn with a wrench.

If a fitting leak persists, disconnect it completely and visually inspect it for mineral deposits or foreign material stuck on the sealing surfaces. Clean the surfaces thoroughly and reinstall the fitting. Take the motor home to an authorized Tiffin Motor homes service center for additional repairs if the water system continues to leak.

Follow the winterizing instructions given in Chapter 15 to reduce risk of leaks caused by cracks from freezing pipes. Left unchecked, freezing damage can be extensive and expensive.

SANITIZING

To ensure complete disinfecting of the freshwater system, Tiffin Motor homes recommends that the following procedures be performed on a new system, on one that has not been used for a length of time, or one that might have become contaminated. This procedure is also recommended before long periods of storage, such as during the winter months:

Drain the freshwater tank by opening the drain valve. All of the faucets should be in the closed or OFF position.

Prepare a chlorine solution using one gallon of water and one-half cup of chlorine bleach (5% sodium-hypochlorite solution). Prepare enough of the chlorine solution to administer one gallon of solution for every 15 gallons of tank capacity. For sanitizing this unit, prepare 4½ gallons of the chlorine solution. This mixture puts a 50 ppm (parts per million) residual chlorine concentration in the water system that will act as a quick-kill dosage for harmful bacteria, viruses, and slime-forming organisms. Concentrations greater than 50 ppm might damage the water lines and/or the tank.

Once the freshwater tank is empty, close the drain valves in the water tank.

Pump the chlorine solution into the tank by taking the hose attachment and attaching it to the pump and then put in the chlorine solution. Close the valve from the fresh water tank to the pump and open the valve from the solution to the pump. Turn the tank fill valve from “city water” to “tank fill.” Turn ON the water pump until all of the solution is pumped into the fresh water tank.

Turn OFF the water pump. Open the valve from the tank to the water pump. Fill the water tank with the city water tank fill (or by using the same method as was used to put the sanitizing solution into the tank). Remove the water filter (from the drink dispenser faucet, if installed). Open each faucet, in turn, including the kitchen faucet, bath faucet, inside and outside showers, turning ON both the hot and cold faucets and flushing the toilet until all of the air has been purged from the pipes and the water runs freely. The entire system will then be filled with the sanitizing solution.

PLUMBING & BATH FEATURES

Allow the 50-ppm disinfecting solution to stand in the system for at least four hours.

Drain the system and flush it with freshwater. The water system needs to be flushed with water repeatedly, if necessary, until there is no chlorine taste or smell left in the system. To remove any excessive chlorine taste or odor that might remain, prepare a solution of one quart of vinegar to five gallons of water. “Rock” the tank containing the solution by moving the vehicle forward and backward several times to clean the tank; then, drain that tank and refill with clean water.

WASTEWATER SYSTEM

WASTEWATER GENERAL INFORMATION

The waste drainage system was designed to provide adequate and safe storage and/or disposal of waste materials. All of the materials used in the fabrication of this system are tested by a nationally recognized testing laboratory. The drainage system uses plastic piping and fittings connected to the sinks, toilet, and holding tanks.

This plumbing permits the drainage of these fixtures to an outside termination. The vehicle should be reasonably level for best operation of both of the wastewater systems.

There are two, separate wastewater systems. The gray-water system is for wastewater from the sinks and shower. The black-water system is for sewage waste from the toilet. Each wastewater tank has its own control valve and both drain through a common sewer-drain hose.

Your Zephyr has a Waste Water Elimination system. Please refer to the manufacture owner’s manual for proper operation.



TOILET

All units are furnished with a mid-toilet (Figure 12-9) and some units are furnished with a mid-toilet and rear macerator toilet (Figure 12-10). Both toilets operate with water from either the fresh water tank with the water pump ON or the city water supply. Before using the mid-toilet or the macerator toilet, add water to the bottom of the tank. Refer to owner manuals for operating instructions, and refer to “Black-Water Holding Tank” instructions.

PLUMBING & BATH FEATURES



Figure 12-9:
Mid-Toilet



Figure 12-10: Rear
Macerator Toilet

- When using your mid-toilet, fill the toilet $\frac{3}{4}$ full of water. To add water to the toilet bowl, lift the flush handle to fill the bowl until the desired water level is reached. To flush the toilet, push the handle down, then release it.

NOTICE

It is important that you use as much water as possible when flushing to prevent tissue and other solids from clogging the holding tank outlet.



Figure 12-11: Rear
Macerator Toilet Switch

- When using your rear macerator toilet (if your coach is furnished with one) press the ADD WATER switch (Figure 12-11) to the desired water level. To flush the toilet, press the FLUSH switch, and then release it.
- The toilet should be cleaned regularly for maximum sanitation and operational efficiency. Clean the toilet bowl with a mild bathroom cleaner.

NOTICE

Do not use chlorine or caustic chemicals, such as bleach or drain opening chemicals in your motor home's toilet. This will damage the seals in the toilet and dump valves.

PLUMBING & BATH FEATURES

BLACK-WATER HOLDING TANK

The “black-water” (i.e., sewage) holding tank is located directly beneath the toilet. Before using the toilet, you will need to treat the tank with water that is mixed with an odor-controlling chemical. These chemicals are readily available at any RV supply store. Pull the toilet levers forward to allow the chemicals to mix with the toilet water. Continue pulling the toilet levers until a depth of at least one inch of solution is directly under the toilet. Release the levers and the waste tank is now ready for use.

GRAY-WATER HOLDING TANK

The gray-water holding tank is located in the underbelly of the vehicle. It is primarily used for the drainage from the kitchen and bath sinks, and the shower.

P-TRAPS

Each of the sink drains and the shower drain has a water trap (P-trap) to prevent holding-tank odors from entering the vehicle.

These traps must have water in them to trap odors. When the vehicle is in motion, the water might splash out of the sink and shower drains. When the vehicle is stored, the water might evaporate from these traps allowing odors to enter the vehicle. If this occurs, run water from the faucet into the drain, allowing water to fill the traps again.

NOTICE

Use only RV odor-controlling chemicals in the holding tanks. Products containing ammonia and petroleum will damage the ABS plastic holding tanks and seals.

PLUMBING & BATH FEATURES

WASTEWATER DISPOSAL

Both of the holding tanks terminate in a valve arrangement that permits draining each tank separately or together.

Drain the black-water tank first before draining the gray-water tank. This procedure permits the water from the gray tank to wash the black-water residue from the drain lines and hose found in the external sanitation compartment.

NOTE: The T-handles (Figure 12-12) are color coded to distinguish between the black-water holding tank and the gray-water holding tank. The black-water holding tank T-handle is black and the gray-water holding tank T-handle is gray.

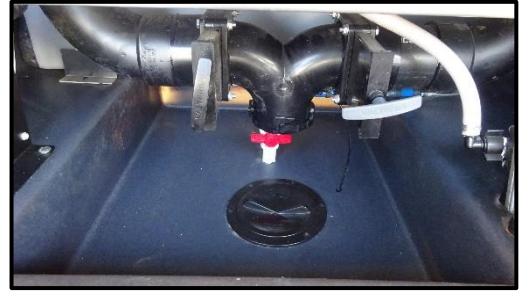

Figure 12-12: Sanitation Coupling

The valves that open to release the water are called gate valves. The blade that closed the opening in the sewer drainpipes is connected to the T-handle to release contents of the tanks when pulled. The sewer line must be securely capped during self-containment use to prevent leakage of waste materials. Do not pull the holding tank gate valve OPEN when the protective cap is installed on the pipe.

Always drain the tank into an acceptable sewer inlet or dump station. Whenever possible, drain both the holding tanks prior to traveling. The carrying capacity of your vehicle will be reduced if water is left in the black or gray tanks. The holding tanks should be drained only when they are at least $\frac{3}{4}$ full. Doing this will provide a sufficient volume of water to allow the complete flushing of waste materials in the drain lines and hose. If the tanks are not $\frac{3}{4}$ full, add enough water to allow for sufficient flushing.

To empty the wastewater tanks, connect the adapter supplied with your vehicle, to the drain hose (Figure 12-12). One end of the hose threads up through the hole in the bottom of the service compartment and the other end of the hose feeds into the sewer at the dump station.

Unscrew the cap from the drain. Connect the hose, with the adapter in place, to the drain fitting. Open the gate valve completely by pulling on the T-handle. The tank will start to drain as soon as the T-handle is pulled. After you have drained the black-water tank, immediately drain the gray-water tank. This procedure helps to flush the black-water from the sewage hose.

When both the tanks are empty, flush them with a freshwater rinse before you close the valves. The gray tanks are flushed by pouring a couple of gallons of water into a sink drain. The drain outlet is engineered for quick release of the drain hose adapter. Always close the gate valves and secure the end cap to prevent leakage while the vehicle is in transit.

After draining the black-water tank, add a holding-tank deodorant to help control the odor and break down the solids. Follow the instructions given on the holding-tank deodorant package.

SEWER CONNECTION AND CAMPING

While using the motor home, it is important to keep the black-water holding tank gate valve closed at all times, except when dumping. This allows an ample amount of liquid to remain in the tank to provide a smooth flow through the gate and the drain valves when dumping.

PLUMBING & BATH FEATURES

Sufficient liquid in the tank causes a swirling action that should take any accumulated solid wastes with it. Accumulation of solid wastes in the black-water tank can be avoided by keeping the gate valve closed when connected to the sewer connection. The gray tank can be kept open while hooked to a sewer connection.

NOTE: Dump the black-water tank first, then the gray-water tank.

NO FUSS FLUSH



Figure 12-13: No Fuss Flush Connection

This vehicle is equipped with a flushing system for the black-water holding tank. When draining your sewer tank, attach a water hose to the tank flush connection. After the tank is drained, leave the gate valve “open” and open the water valve to allow water to spray inside the black-water tank. This will clean the inside of the tank of any debris that might be left inside the tank. After this procedure is done, disconnect the freshwater hose and close the gate valve.

NOTICE

Be sure the gate valve is OPEN when flushing the tank. Do not use the same hose for the No Fuss Flush that is used for filling the fresh water tank.

EXTERIOR SHOWER

Your motor home has an exterior shower (Figure 12-14) for your use and convenience outside the motor home.

The exterior shower is located in the service compartment on the driver’s side and enables you to do such things as rinse off sand or grass, muddy shoes, or bathe yourself outside of your motor home.

The faucet operates just as it would in your kitchen or bathroom.

There is also a soap dispenser and light conveniently located in the compartment.



Figure 12-14: Exterior Shower and Shower Light

PLUMBING & BATH FEATURES

AQUA-HOT HEATING SYSTEM



The Zephyr is equipped with an Aqua-Hot heating system (Figure 12-15) that provides a continuous, on-demand supply of domestic hot water, and interior zone heating where and when it is needed.

To activate the Aqua-Hot heating system, the Aqua-Hot switch (labeled “diesel burner switch”) located in the side cabinet above the driver’s seat must be activated. By activating this switch, a supply of hot water as well as interior heat can be provided.

In the Zephyr, the controls for the Aqua-Hot heating system are integrated with the Spyder Controls System.

To operate the diesel burner, touch the flame icon on any touch panel. This will use diesel fuel.

To operate the electric element, touch the lightning icon on the touch panel. This will use 120 VAC. 110V power must be available to use this feature.

To activate the Aqua-Hot heating system, select the Aqua-Hot option from the Spyder Controls System home screen. By activating this switch, a supply of hot water as well as interior heat can be provided.

The heating feature will be controlled by the thermostat mounted on the Spyder Controls System. It is operated off the furnace function of the thermostat to provide interior heat. Hot water will be supplied instantaneously and continuously at any time the diesel burner switch is activated.

If interior heat and hot water are demanded from the Aqua-Hot system at the same time, hot water will simultaneously take precedence over interior heat; therefore, causing the interior heat to shut down and turn off until the water flow is turned off from water sources.

Also featured in the Aqua-Hot system is an electrical burner switch (labeled Electric Water Heater). With this switch activated and shore power available, it will supply a very limited amount of hot water and limited interior heat.

The surge tank (Figure 12-16) located in the basement should be routinely inspected to make sure the antifreeze fill line stays in the acceptable zone. If the antifreeze becomes low, you must add the recommended antifreeze stated in the Aqua-Hot owner's manual. If antifreeze is totally depleted from the surge tank, a switch will be released inside the main Hydro-Hot tank, disabling the system from operating. Antifreeze will then have to be added to the tank to reactivate the switch and allow the system to operate.



Figure 12-16: Aqua-Hot Surge Tank

If batteries accidentally become discharged and the Aqua-Hot system is activated, the system will automatically shut down before batteries are totally discharged. Once power is restored to batteries, the system must be reset on the outside control board.

PLUMBING & BATH FEATURES

NOTICE

Your Aqua-Hot heating system operates off the motor home's sole diesel tank. Keep in mind that the Aqua-Hot fuel tube is located higher up in the diesel tank than the motor home's engine fuel in order to prevent complete depletion of the diesel fuel tank. **BE SURE AN ADEQUATE AMOUNT OF FUEL IS IN THE TANK BEFORE DRY CAMPING.**

NOTICE

Yearly maintenance is required on the burner portion of the Aqua-Hot heating system.



WARNING

DO NOT operate the diesel-burner and/or the electric heating element without the water and propylene glycol solution in the Aqua-Hot's boiler tank. Failure to do so will cause **SERIOUS DAMAGE** to the heater.

PLUMBING & BATH FEATURES

PLUMBING DIAGRAM

45FZ

Water Line Layout

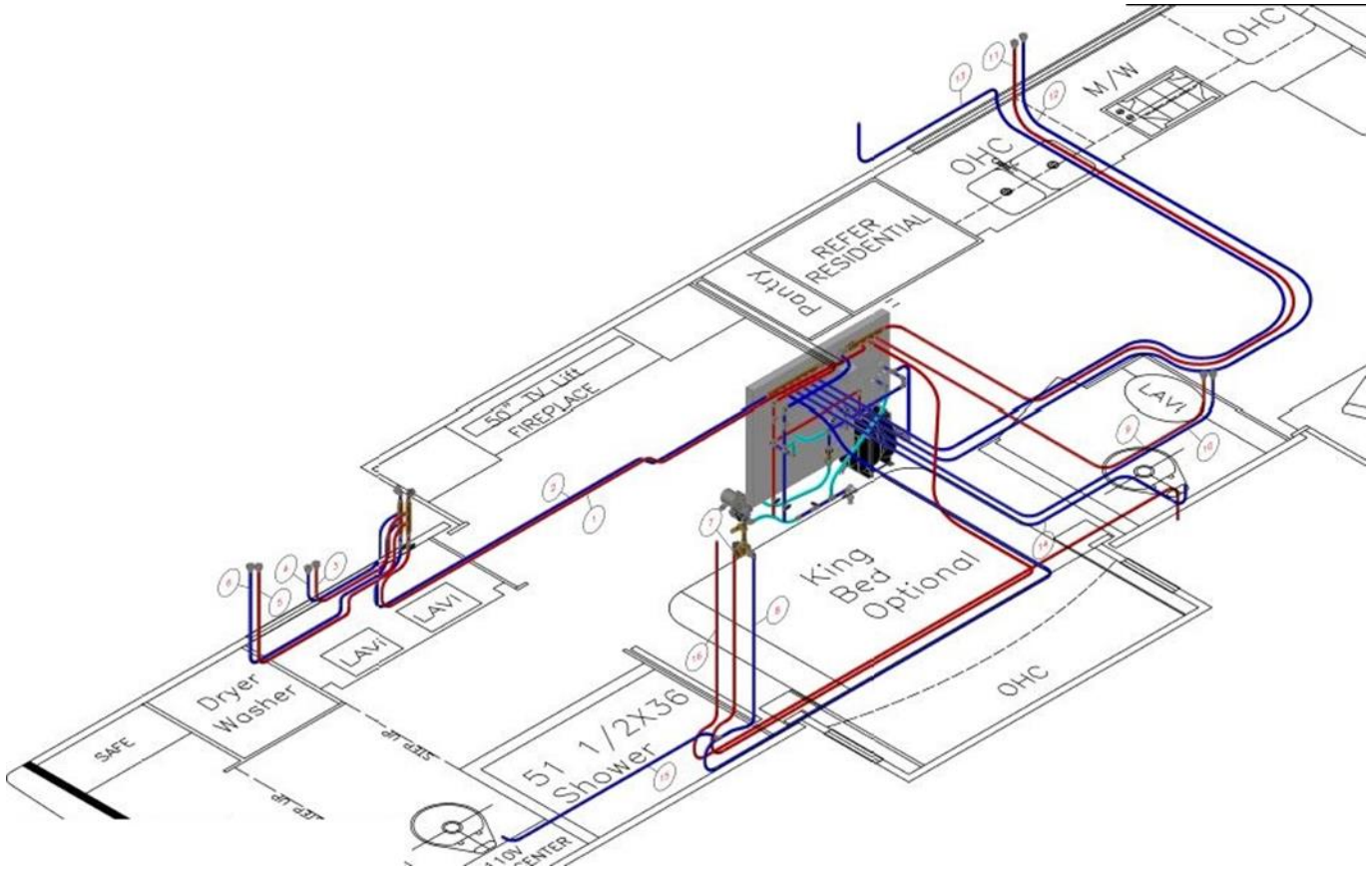

PLUMBING & BATH FEATURES

Sewer Board Assembly

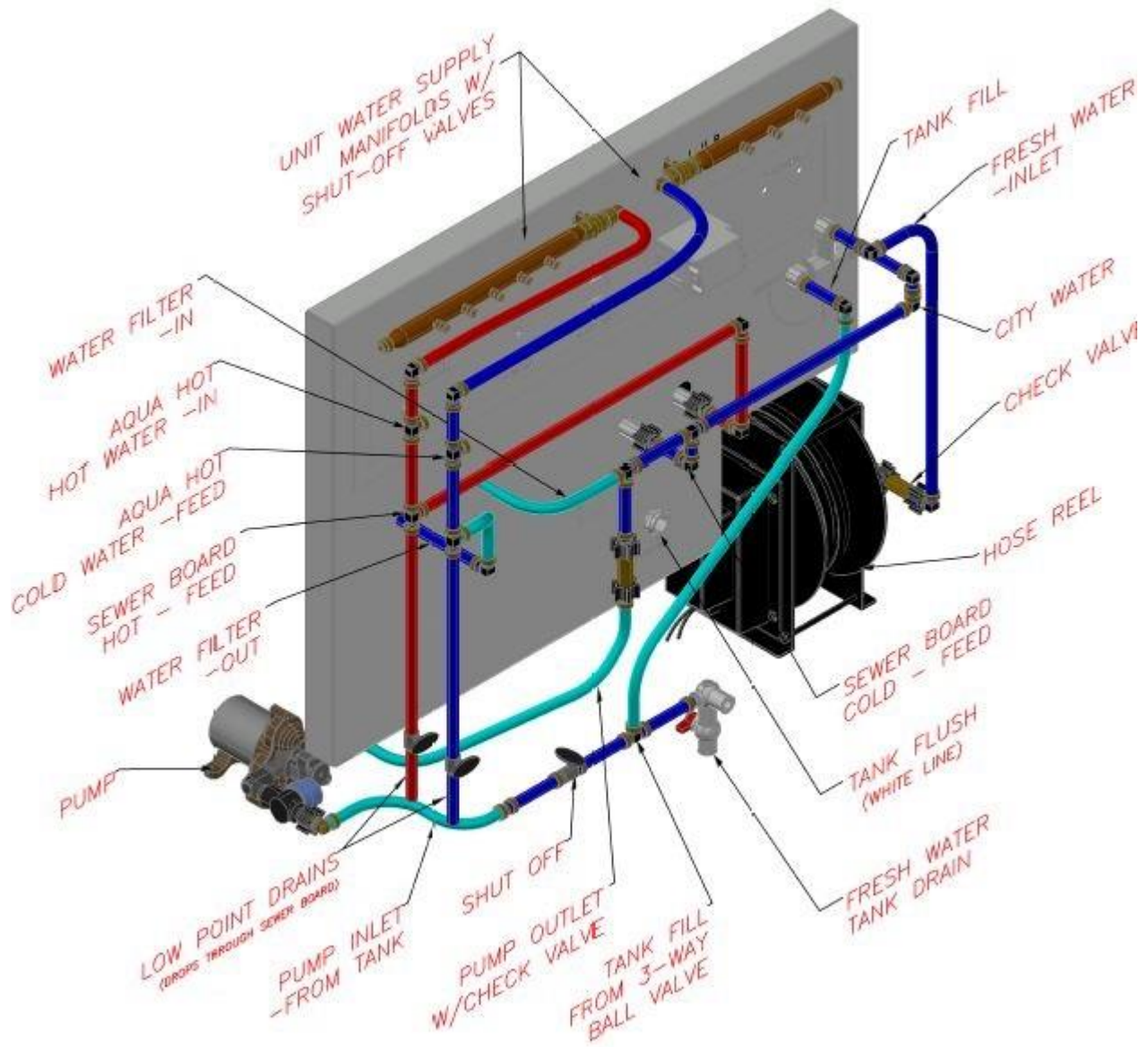

PLUMBING & BATH FEATURES

Drain Line Layout

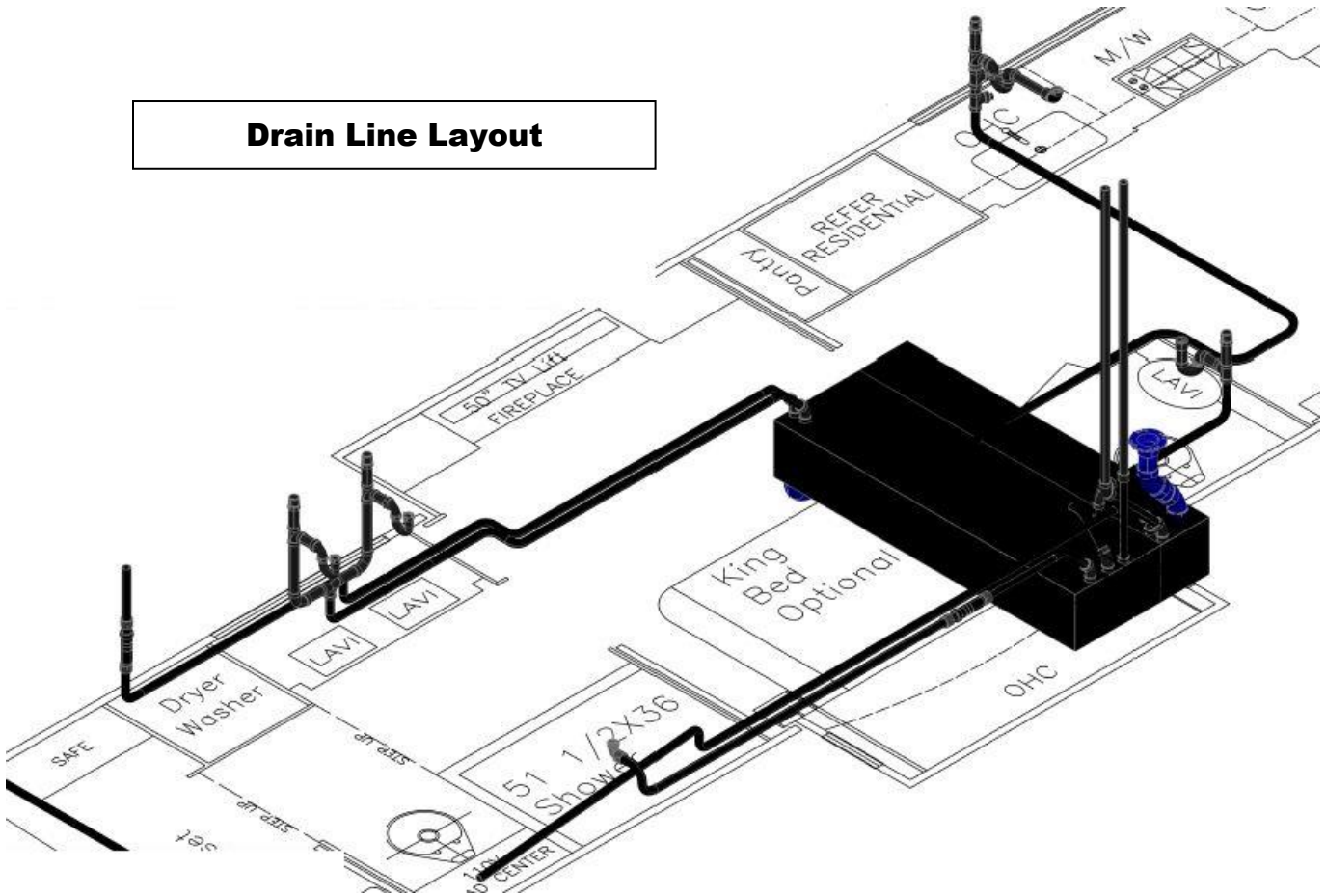

PLUMBING & BATH FEATURES

Plumbing Floor Plan

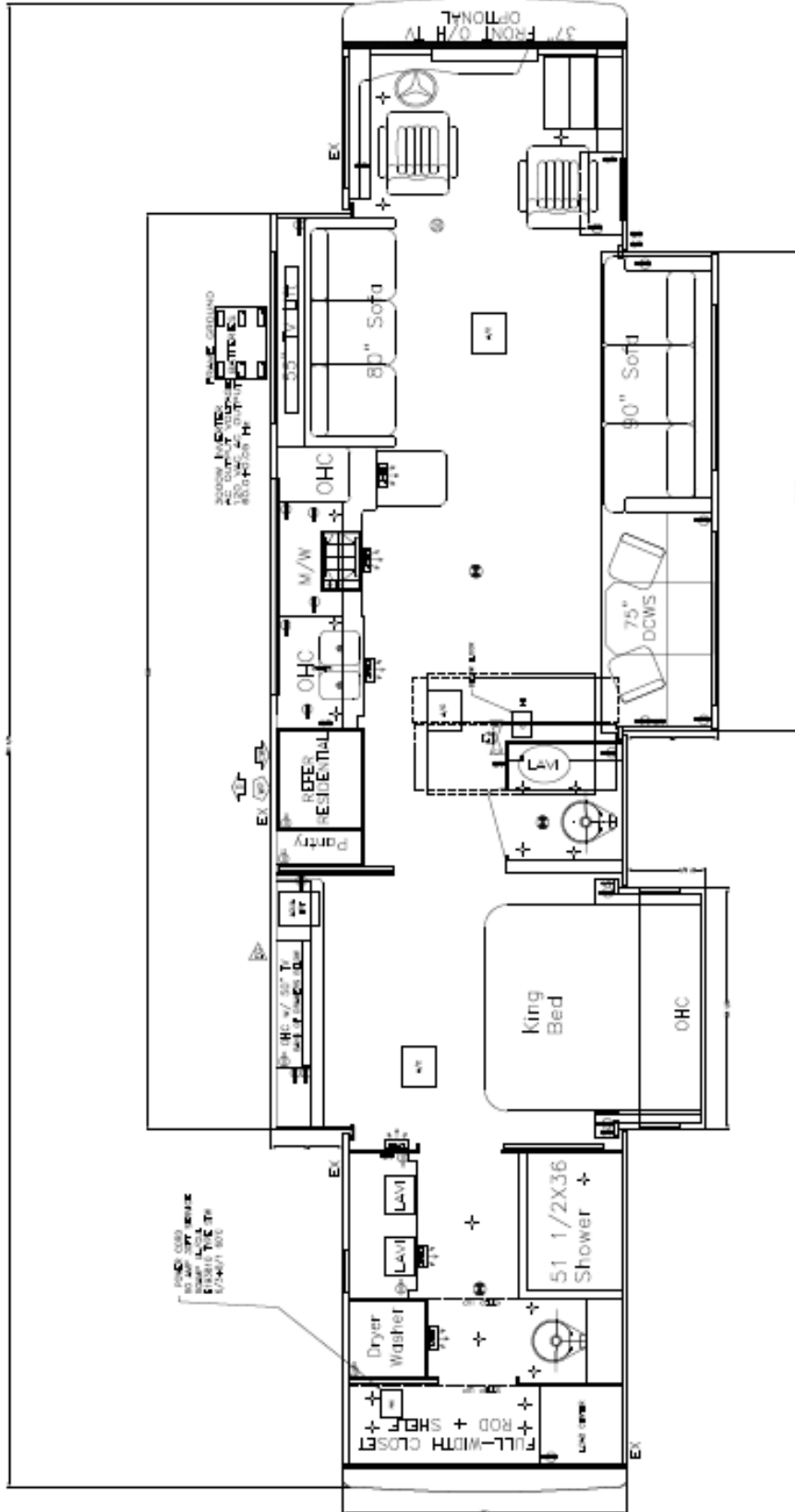

ZEPHYR

WINDOWS, AWNINGS, VENTS, & DOORS

Chapter

13

WINDOWS, AWNINGS, VENTS & DOORS

WINDOWS

Sliding windows (Figure 13-1) are custom built for the motor home and allow easy sliding access to open the coach to fresh outside air.

There might also be a reflective coating on the windows to reflect back a portion of the sunlight to reduce the heating of the motor home interior and to reduce the effects of the sun's "bleaching" of interior fabrics (curtains, upholstery).

Sunshades on both the driver and passenger's sides can be deployed and moved at any time.

Windows throughout the coach are designated as "EXIT" windows in the event of an emergency.

To help make the windows slide more easily, we recommend using Plexus Plastic Cleaner, which can be purchased through the Tiffin Motor homes Service Department.



Figure 13-1: Motor home Windows

AWNINGS



Figure 13-2: Awnings

The unit is equipped with Girard awnings (Figure 13-2). The awnings run on 120 VAC. The awning control switch is located in the front overhead cabinet above the driver's seat. This switch can be removed from the overhead, and used as a remote control to operate the awnings. For the Zephyr, this switch also operates the exterior TV door.

The awning control switch is designed to allow the user to control each awning (if optional) individually.

To use: turn system power ON at the control panel. The remote has a maximum operating range of 50 feet. Actual distance may vary depending on the specific installation and location of the receiver in the vehicle. The Auto-Retract system is active when the awning power is on and disabled when the power is shut off. To turn on the system, press the power button ON at the master panel. The Direct Response system detects awning motion caused by windy conditions. The motion sensor is located in the lead rail. The system operates by gauging the vertical motion of the



Figure 13-3: Awning Remote Control

WINDOWS, AWNINGS, VENTS & DOORS

awning's leading edge. When persistent motion exceeds the factory pre-set threshold for 2 seconds or longer, the system automatically retracts the awning to the slide-out position. The control panel provides four factory pre-set sensitivity values (threshold values). You may have to experiment to find the best setting for your preferences.

There are arrows located on the bottom left and right corners of the awning control switch. These arrows allow you to select front or rear awning.

NOTE: The numbers range from 0 to 5, but 1 (front) and 2 (rear) are used for the awnings.

Once the awning has been selected for operation, the light button activates the light on the awning. The arrows facing up and down on the right-hand side of the switch allow the awning to extend and retract. The button in the center (that is a line) on the right side of the switch allows the user to stop the awning at a desired location instead of fully extending or retracting. Refer to your Girard dealer for more in-depth awning questions.

In case of awning power failure or to manually close the awning:

The Girard GG750 has a manual override to close the awning in case of power failures.

Remove the endcap opposite the motor, by removing the 3 Philips head screws.

Using a 13mm wrench, turn the square manual override shaft in order to close the awning, see Figure below.

NOTE: The manual override is one-way, it can only be used to close the awning.

Replace endcap using the 3 Philips head screws.

Figure below is showing a right hand motor version of the GG750. If your coach is equipped with a left hand version, the manual override will be on the opposite side.

Once power is restored, the awning will resume normal operation.

NOTE: This procedure can also be used to manually retract the Over the Door Awning.

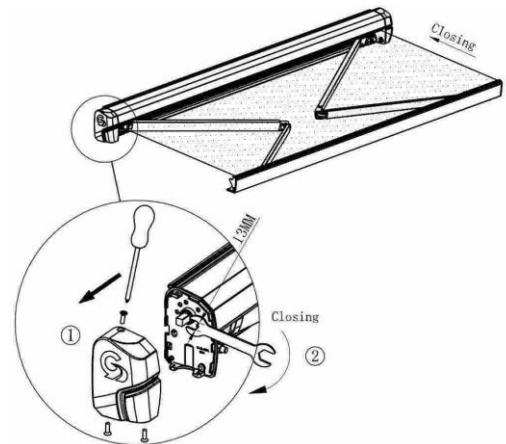

WARNING

Since damage resulting from weather is not under warranty, anytime a heavy or prolonged rain or blustery winds are anticipated, it would be advisable to close the awning. Similarly, if the awning is to be left unattended for any prolonged length of time, you should close that awning.

WINDOWS, AWNINGS, VENTS & DOORS

VENTS

The kitchen and bathroom are both equipped with a 12 VDC exhaust vent (Figure 13-6). The fans are controlled by the fan tab on the Spyder Controls System (Figure 13-7). A three-speed switch on each vent fan controls the fan speed.



Figure 13-6: Overhead Vent Fan



Figure 13-7: Vent/Fan Controls

IMPORTANT: The vent fan must be left in the ON mode only when the motor home is parked and in use. The fan will not operate until the vent is open.

DOORS

The primary entrance door to the motor home has a key lock and a dead bolt for additional security. When the door is fully opened, the door hinge automatically holds the door in an OPEN position.

In addition, a screen allows increased air circulation when the entrance door is open.



WARNING

Always secure the dead bolt lock while the motor home is in motion to prevent accidental opening of the entrance door.

WINDOWS, AWNINGS, VENTS & DOORS

KEYLESS LOCK

The Zephyr is equipped with keyless lock entry. (Figure 13-8). The keyless lock entry is essentially a numeric combination lock.

This type of lock for the motor home enables the owner to come and go without having to worry about whether the “house key” was with the owner or not. The keyless lock drastically reduces the inadvertent situation of being “locked out of one’s home” while on the road.

Also included with the keyless entry is a key fob that will lock and unlock the entrance door as well as compartment doors. The headlights and clearance lights will flash, indicating that the doors are locked when pressing the lock button on the key fob. When pressing “unlock,” the porch lights will be activated for 30 seconds.

As long as you remember the appropriate combination (settable by the owner to permit optimal remembering of a preferred numerical combination), you should never be “locked out” of the motor home under any circumstances.

Complete directions for setting your unique keyless lock combination can be found in the Owner’s Information Package.

As a further aid for nighttime access to the motor home, the handrail by the front door is made of transparent acrylic, which is lighted at night. This “night light” handrail permits the motor home owner easy and safe access to the motor home by providing a firm, easily seen handhold whenever entering or exiting.



Figure 13-8: Zephyr Keyless Lock

ZEPHYR

DRIVING YOUR MOTOR HOME

Chapter

14

DRIVING

INSTRUMENT PANEL

The instrument panel on your Zephyr serves as a multi-function device. Not only does it provide information regarding fuel level and RPM, it provides tire pressure, levelling function and Mobile Eye information.

LEVELLING THE ZEPHYR: INSTRUMENT PANEL.

Leveling zero-set adjusts the level reference used when the vehicle is in AUTO or MANUAL leveling mode. This allows the system to level to the same level every time.

The coach must be sitting on level ground supported by its own suspension; no jacks, blocks, or other obstructions should be under the coach.

The ignition must be on with the engine running and the park brake set.

Access Zero-set Manual Air by navigating to:

Home > More > Setup > System > Manual Air

NOTE: Zero-set Manual Air mode will NOT protect the coach against twist, so care must be taken when in this mode.

Place a bubble level on the floor at the front/rear of the coach oriented laterally across the coach. Press the FRONT/REAR RAISE or LOWER buttons in pairs to level the coach side-to-side at each axle.

Rotate the level so it is oriented longitudinally. Press both FRONT RAISE or LOWER buttons in pairs to level the coach front to back. Operating the valves in pairs equalizes the air pressure in the suspension and removes twist from the coach.

Press the ZERO SET button to zero-set the level. After about three seconds, the touch screen will beep indicating zero-set has completed and the bubble levels on the screen should all be in the center of the level bar. Repeat if necessary.

Please refer to your chassis operator's manual for details regarding the operation of these items.

CAMERA MONITOR SYSTEM



Figure 14-1: Xcite Radio System and Camera Monitor

The cameras associated with the Xcite system is the default setting on your Aux Zone monitor. However, you are able to access the camera system on your main monitor in one of two ways. One is by selecting the CAM button on the main monitor, and the other is by pressing MENU on the main monitor and then selecting Camera (Figure 14-1).

Once the camera is on the main monitor, you can change the camera view to the left camera, right camera, or rear camera. Making this selection will change both your main screen and your aux zone screen to this camera view (Figure 14-2).

DRIVING

A camera mounted on the rear of the vehicle feeds a televised view of the rear of the motor home to the monitor located in the front near the driver.

Three Sixty (360) Camera

The 360 Camera gives you the ability to view all sides of your unit and even the top. (Figure 14-2a). To activate the system, depress MENU and select HD CAM.



Figure 14-2: Camera View

NOTE: When the turn signals are activated, the main monitor will show the camera corresponding to the turn signal that was activated. When the turn signal is deactivated, the main monitor will return to its previous state.



Figure 14-2a

SECONDARY PASSENGER MONITOR



Figure 14-3: Secondary Passenger Monitor

To change the default view of your aux zone monitor and/or your secondary passenger monitor (Figure 14-3), perform the following; press the menu button on the main monitor and then select the AUX ZONE button. Once you are on the AUX ZONE page, you will be able to toggle the views of the two aforementioned screens with options such as camera, HDMI, navigation, etc.

For more information regarding the Xcite system, refer to [the Xcite manual that is provided with the motor home.](#)

CB RADIO SYSTEM ANTENNA CONNECTION

As an option, the motor home might come equipped with an antenna and coaxial cable connection to enable the owner to install a Citizens Band (CB) radio of choice, and operate it conveniently from the motor home.

The coaxial-cable connection for the radio is found beneath the dashboard on the driver's side. Accordingly, with an owner-provided CB radio, that radio can be used to communicate with other travelers on the road.

To use one's CB system of choice, follow the directions furnished with the CB radio.

NOTE: Channel 11 is considered an emergency channel and monitoring this channel might give one information about road conditions, accidents, and related matters potentially affecting your travels.

DRIVING

XCITE RADIO SYSTEM

The Zephyr is standard equipped with the Xcite Radio System (Figure 14-1). The Xcite System is equipped with AM, FM, and Sirius XM capabilities. It also comes standard with a Rand McNally Navigation System.

The system comes with three monitors: the main monitor, the aux zone monitor, and the secondary passenger monitor. The main monitor and secondary passenger monitor have touch screen capabilities while the aux zone monitor does not.

DASHBOARD HEATING/COOLING CONTROLS

The dash air conditioner/heater (Figure 14-4) is not designed to heat and cool the entire interior of the motor home. It is intended only to provide heating and cooling for the cab area.

A small amount of air will blow out of the defrost and dash vents regardless of the mode settings.



Figure 14-4: Dashboard Controls

MOBILEYE COLLISION MITIGATION SYSTEM (OPTIONAL)

Your Zephyr might be equipped with an optional Mobileye collision mitigation system that aids drivers in avoiding accidents.

Please refer to your chassis operator's manual for detail information regarding this system.

ON GUARD ADAPTIVE CRUISE CONTROL

Adaptive Cruise Control (ACC) automatically adjusts the speed of your vehicle while in cruise control and attempts to maintain a set following interval of 3.6 seconds when there is a vehicle ahead. ACC works with conventional cruise control to maintain the set cruise speed when the lane ahead is clear and will automatically adjust the vehicle's speed to maintain the set following interval when a vehicle ahead is detected. To control this system please use the instrument panel. There are three different settings for distance following.



AFO Supplemental Braking System

Your ZEPHYR is equipped with the Air Force One supplemental braking system. This system will provide years of maintenance and adjustment-free service. This proportional braking system uses the air pressure from your RV's brakes to apply the brakes in your towed car in the same manner. Low-profile design installs out of your way and is always at the ready. Please refer to the Manufacture's manual, which is a part of your operator's packet.



ZEPHYR

ROUTINE MAINTENANCE

Chapter

15

ROUTINE MAINTENANCE

NOTICE

Damage caused by improperly performed maintenance or inadequate maintenance is not covered by your Tiffin Motor homes limited warranty.

WASHING

The paint on your Tiffin motor home has a polyurethane base called Diamont. While multiple layers of clear coat sealants protect the paint against oxidation, the sealant must be protected from deterioration (Figure 15-1).

Paint manufacturers advise against using harsh cleaners such as Simple Green, Mr. Clean, or liquid dishwashing soaps. The degreasing agents in these cleaners leave a residue on the sealant, which soften and damage the clear coat in time.

Baby shampoo provides an effective yet gentle cleaner. Without the typical heavy degreasers of most detergents, baby shampoo cleans without leaving a residue to gum up the clear coat finish. Generally, one ounce (1 oz.) is all you need per five-gallon bucket of water. Add one cup of food grade distilled white vinegar to your wash bucket.

Tiffin Motor homes recommends the lamb's wool pad sold by Mary Moppins. This enables you to safely wash your coach from the ground by placing the pad on an extension.

Do not mistake lamb's wool with imitations. Imitation pads are made from 100% polyester, which is plastic. Plastic imitations will scratch the finish of the motor home. For this same reason, avoid microfiber products to wash or dry your motor home. Microfiber is made from 80% polyester.



Figure 15-1: Typical Motor home Exterior



CAUTION

DO NOT use any type of brush or plastic wash materials on the exterior paint as this could cause damage to the finish of your motor home. Even though you might not see brush marks now, the damage will happen as the bristles wear down.

ROUTINE MAINTENANCE

Use only 100% cotton towels to dry your vehicle. Adding vinegar to your wash water and washing in the morning or evening will help prevent water spots. Water spots damage the exterior of your coach the same way they damage glass shower doors. They etch their way into the surface and removal becomes difficult. Prevention becomes the key.

Wash one side at a time, rinse, and then dry quickly using a squeegee followed by a towel placed over the cleaning head.

To remove oil and grease, remember an important rule of cleaning: give your product time to work. Dab a bit of concentrated cleaner like CleanEz by Mary Moppins—never an orange-based cleaner or one with petroleum distillates—onto a soft cloth. Apply to the oil spot and wait for 10 to 15 minutes before rubbing lightly to remove the oil. Rinse immediately.



SEALS

The seals around the doors, windows, vents, slide-out trim and external seams should be checked at least semi-annually. Additionally, the roof seams should be inspected for cracking or peeling semi-annually. If deterioration is noted during a routine maintenance inspection, reseal the seams or seals with an approved sealant to prevent leaks.

Your Tiffin Motor homes dealer can perform resealing inspections and subsequent work for you. Tiffin Motor homes recommends that a Tiffin Motor homes authorized service center perform these inspections periodically and perform necessary resealing when necessary.

ROUTINE MAINTENANCE

PROPER SEALANTS FOR APPLICATION

The following sealants are recommended for specific sealing applications, as noted in the table. These can be purchased through the Tiffin Motor homes parts and service department by calling 256-356-0261.

RECOMMENDED SEALANTS FOR SPECIFIC SEALING APPLICATIONS	
SEALANT	APPLICATION
Plas-T-Code	Metal or fiberglass roof
Surebond #SB-140	Rubber laminated to metal roof and ALL SKYLIGHTS
Carlisle #502-LSW self leveling sealant	Rubber roof over wood base
Silicone sealant	To cover butyl and other sealants; not to be used as the main sealant
Parbond	To seal across tops of windows on exterior surfaces where silicone is not used

NOTICE

Do not use solvents such as acetone, MEK, toluene, and the like on the decals. Any solvent including alcohol might soften and smear colors. Do not use lacquer thinner or paint thinner on decals. Do not overcoat the decals with clear paint. Do not allow gasoline or other fuels to come into prolonged contact with the decals. However, if this should occur, immediately flush the affected area with water.

ROAD SALT AND OTHER ROAD TREATMENTS

While many owners do not normally operate their coach on salt or otherwise treated winter roads, the following is suggested: Thoroughly wash the exterior, the undercarriage, and the engine compartment of your coach. If you find it necessary to utilize a commercial wash service, refrain from using brushes or highly caustic wash agents on your coach. Also, when washing the engine compartment, always remain mindful of the electrical and electronic components. Do not spray high-pressure water directly on these components.

WHEEL CARE

The care and maintenance of your wheels are simple and require no special material or products; follow the directions included in the Owner's Information Package for these. Timely care and cleaning will maintain the appearance of these wheel products for many years.

ROUTINE MAINTENANCE

Be sure to completely wash the aluminum wheels free of all road treatment salt or other chemicals, paying close attention to the area behind the decorative lug nut covers.

	CAUTION
<p>Do not use harsh detergents, acids, or abrasives, which might scratch or dull the surfaces. The applicator cloth, sponge, or soft-bristled brush should be non-metallic and non-abrasive. Also, remember to check the tightness of the wheel lug nuts frequently.</p>	

ROOF CARE & MAINTENANCE

Proper care and maintenance of your motor home, including your roof, is important for sustained, trouble-free performance. Normal maintenance is simple and easy and does not require special materials.

The roof of the motor home is fiberglass and can be cared for in the conventional manner. Clean the roof at least every three months. The roof should be professionally inspected by a dealer annually.

	WARNING
<p>Use caution when working on the top of your motor home. The wet roof might be extremely slippery and, as such, a possible safety hazard.</p>	

MOISTURE MANAGEMENT

This section outlines important recommendations to manage moisture in your motor home to avoid moisture-related damage, such as mold. The materials and methods used to construct your motor home were selected in part to minimize air leakage and to create a weather-tight exterior shell. However, in order to protect your investment, and reduce the risk of moisture-related damage and costly repairs, attention and care has to be taken to manage moisture inside your RV.

ROUTINE MAINTENANCE

NOTE: These are only suggestions intended to minimize moisture-related issues with your motor home. If any concerns arise, contact Tiffin Motor homes' Service Department at (256) 356-0261.

INTERIOR CARE OF YOUR RV

Signs of excessive moisture can be obvious, such as water droplets forming on surfaces or wet carpet. Conversely, signs of excess moisture can be subtle, such as condensation forming on metal surfaces. When symptoms appear, it is important to immediately determine the cause of the excess moisture and take appropriate corrective action to prevent moisture-related damage.

CONTROL RELATIVE HUMIDITY

Monitoring and controlling relative humidity within the motor home is one of the most important steps to minimize the risk for moisture-related damage. Ideally, relative humidity should be at 60% or less. Relative humidity can be monitored utilizing a portable hygrometer, which is a small device that measures temperature and relative humidity.

Use exhaust fans, the air conditioner, and/or a portable dehumidifier to manage moisture inside the RV to maintain relative humidity at 60% or less. In cold climates, relative humidity might need to be at 35% or less to avoid window condensation issues. If the motor home is used, the majority of the time in a hot, humid climate, it might be difficult to keep relative humidity below 60%. A dehumidifier will help, but check the condensation (water) collection bucket regularly or discharge the condensation (water) directly to a drain.

AVOID DRASTIC THERMOSTAT SETBACKS

To minimize the opportunity for condensation to form on interior surfaces, maintain a comfortable temperature in your RV, and avoid nighttime setbacks of 10 degrees or more. Drastic setbacks that reduce the indoor air temperature quickly can increase the chance for airborne moisture to condense on cool surfaces such as windows. If you are away from your RV for an extended number of days, do not set the temperature back without taking other measures to manage relative humidity, including operating a dehumidifier with a continuous drain.

MANAGE WINDOW CONDENSATION

Window condensation issues can be identified by water or ice build-up, usually at the base of the window. The majority of these problems can be addressed by managing moisture generated inside the motor home. Minor condensation issues are not unusual, especially for RVs used in colder climates. To help minimize window condensation, use exhaust fans vented to the outside, avoid drastic changes in thermostat settings, do not use "vent-free" heaters, and use window coverings wisely. For example, make sure to open curtains or blinds during the day to allow air to circulate and warm the window surface.

ROUTINE MAINTENANCE

CARPET CARE AND MOISTURE MANAGEMENT

The carpet should be cleaned when it shows signs of discoloration or traffic patterns. A steam cleaning system should be used to clean the carpet unless otherwise noted in your warranty information. To manage moisture from the cleaning process, the cleaning system needs to be capable of extracting the excess water from the carpet after it has been cleaned.

IMPORTANT: Be sure the carpet is thoroughly dry before closing up the RV for storage. Water from the cleaning process can cause significant damage to the RV if the carpet is not completely dry before closing up the motor home for an extended period.

CLEANING TILE AND WOOD FLOORS

Most floors only require a mild detergent and warm water for cleaning. More water on the floor is not always better for cleaning. Use a damp cloth to clean on a regular basis rather than wet mopping each time.

STORAGE AND OTHER ISOLATED AREAS WITHIN THE RV

Storage areas are more difficult to condition since the areas are isolated from the main body of the RV. The surfaces of these areas are more at risk for condensation and surface mold growth. To minimize this risk, clean storage areas regularly, and allow an air space between stored items and the exterior wall to promote air circulation.

USE OF UN-VENTED COMBUSTION EQUIPMENT

Un-vented combustion equipment, such as propane stovetops are a source of moisture within the RV. For every gallon of fuel consumed, approximately one gallon of water vapor is evaporated into the air. Whenever possible, operate an exhaust fan in combination with the use of any un-vented combustion appliance within the RV. Water vapor and other combustion by-products must be vented to the exterior of the RV. The RV owner should strictly follow use and maintenance instructions for safe operation of any combustion equipment, particularly un-vented equipment.

EXTERIOR CARE OF YOUR RV

The exterior shell of the RV is the primary weather and moisture barrier. Over the life of the vehicle, the shell will require regular care and maintenance in accordance with other instructions for exterior care. The shell includes the roof, sidewalls, windows, doors, and under-floor of the vehicle. Particular attention needs to be devoted to ensure these components are maintained to ensure a tight barrier against bulk water intrusion. The shell should be inspected periodically for tears, gaps, and condition of sealants in accordance with this owner's manual. Areas that require maintenance should be resealed using a similar, high-quality sealant used by the manufacturer. Particular attention should be devoted to ensure the slide outs are functioning properly. Each time a slide out is used, it should be inspected to ensure proper operation and sealing. The slide out gaskets must also be inspected to ensure proper sealing when the slide out is operated.

ROUTINE MAINTENANCE

USE OF YOUR RV

It is important to remember that the square footage of an RV is significantly less than that of a single-family residence. This fact alone will elevate the relative humidity because there is less volume of air to help absorb or dissipate the humidity. For example, showering and cooking create a lot of humidity in a small area. In these instances, use of an exhaust fan and opening windows should reduce the relative humidity, particularly when living in the RV for an extended period.

SEVERE ENVIRONMENTS

Prolonged use of your RV in severe environments—for example in extremely cold or hot-humid climates, will require extra care and maintenance to avoid moisture-related issues. In both extremely cold and hot humid climates, more attention needs to be focused on controlling the relative humidity within the RV. It also might require the use of a portable dehumidifier to manage the relative humidity within an acceptable range.

STORAGE OF YOUR RV

During those periods when your motor home is not in use, care must be taken to ensure moisture sources are addressed. Ideal storage of your RV would be in an enclosed, climate-controlled environment. When this is not possible, the following steps should be taken to ensure moisture is controlled:

- Turn off all water sources.
- Turn off all combustion appliances.
- Drain the water tanks.
- Drain the water heater.
- Open all closets, cabinet doors, and drawers.
- Close all windows and entrance doors.
- Open a vent or a window enough to allow for some limited ventilation airflow, but not so far as to allow snow or rain to enter.
- When storing the RV in high humidity climates, add a dehumidifier drained to exterior to control the humidity inside the RV during storage.
- Refer to other sections of this owner's manual for additional recommendations.

MODIFICATIONS TO YOUR RV

Consult Tiffin Motor homes for guidance before making any modifications to your RV. It is important that changes be completed by a qualified service firm to ensure that moisture intrusion or accumulation problems do not occur.

ROUTINE MAINTENANCE

WET AREAS

Areas that are exposed to water spills or leaks should be dried as soon as possible and definitely within 24 to 48 hours. Drying areas quickly minimizes the chance for moisture damage and possible mold growth, which can begin to form colonies within 48 hours. A variety of methods can be used to help the drying process:

- Remove excess water with an extraction vacuum.
- Use a dehumidifier to aid drying.
- Use portable fans to move air across the surface.
- Because moisture is key to mold issues, treat all signs of condensation and spills seriously and deal with promptly. Failure to deal with a moisture issue promptly might cause more severe issues where none initially existed, or might make a small problem much worse.
- Learn to recognize signs of mold—do not paint over or cover up suspicious discoloration until you are sure it is not mold. The affected surface must first be cleaned and dried; residual staining may be painted.
- Be sure to understand and eliminate the source of moisture accumulation as a part of the cleanup. Otherwise, the same issues will reoccur.
- Small amounts of mold should be cleaned as soon as it appears. Small areas of mold should be cleaned using a detergent/soapy solution or an appropriate RV household cleaner. Gloves should be worn during cleaning. The cleaned area should then be thoroughly dried. Dispose of any sponges or rags used to clean mold.

TIRE & SAFETY INFORMATION

This portion of the Owner's Manual contains tire safety information as required by 49 CFR 575.6. The National Traffic Safety Administration (NHTSA) can be contacted at 1-888-327-4236. Their website is <http://www.safercar.gov> and their address is NHTSA, 400 Seventh St, S.W., Washington, D.C. 20590.

SECTION ONE

The National Traffic Safety (NHTSA) has published a brochure (DOT HS 809 361) that discusses all aspects of Tire Safety, as required by CFR 575.6. This brochure is reproduced in part below. It can be obtained and downloaded from NHTSA, free of charge, from the following website: <https://one.nhtsa.gov/cars/rules/TireSafety/ridesanit/brochure.html>

Studies of tire safety show that maintaining proper tire pressure, observing tire and vehicle load limits, avoiding road hazards, and inspecting tires for cuts, slashes, and other irregularities are the most important things you can do to avoid tire failure, such as tread separation or blowout, and flat tires.

These actions, along with other care and maintenance activities, can also:

- Improve vehicle handling.
- Help protect you and others from avoidable breakdowns and accidents.

ROUTINE MAINTENANCE

- Improve fuel economy.
- Increase the life of your tires.

This section presents a comprehensive overview of tire safety, including information on the following topics:

- Basic tire maintenance.
- Uniform Tire Quality Grading System.
- Fundamental characteristics of tires.
- Tire safety tips.

Use this information to make tire safety a regular part of your vehicle maintenance routine. Recognize that the time you spend is minimal compared with the inconvenience and safety consequences of a flat tire or other tire failure.

Safety First-Basic Tire Maintenance

Properly maintained tires improve the steering, stopping, traction, and load-carrying capability of your vehicle. Under-inflated tires and overloaded vehicles are a major cause of tire failure. Therefore, as mentioned above, to avoid flat tires and other types of tire failure, you should maintain proper tire pressure, observe tire and vehicle load limits, avoid road hazards, and regularly inspect your tires.

Finding Your Vehicle's Recommended Tire Pressure and Load Limits

Tire information placards and vehicle certification labels contain information on tires and load limits. These labels indicate the vehicle manufacturer's information including:

- Recommended tire size.
- Recommended tire inflation pressure.
- Vehicle capacity weight (VCW—the maximum occupant and cargo weight a vehicle is designed to carry).
- Front and rear gross axle weight ratings (GAWR—the maximum weight the axle systems are designed to carry).

For motor homes: Both placards and certification labels are on a sticker that is located in the rear closet.

Understanding Tire Pressure and Load Limits

Tire inflation pressure is the level of air in the tire that provides it with load-carrying capacity and affects the overall performance of the vehicle. The tire inflation pressure is a number that indicates the amount of air pressure—measured in pounds per square inch (psi)—a tire requires to be properly inflated. (You will also find this number on the vehicle information placard expressed in kilopascals (kPa), which is the metric measure used internationally).

Vehicle manufacturers determine this number based on the vehicle's design load limit, that is, the greatest amount of weight a vehicle can safely carry, and the vehicle's tire size. The proper tire pressure for your vehicle is referred to as the "recommended cold-inflation pressure."

ROUTINE MAINTENANCE

Because tires are designed to be used on more than one type of vehicle, tire manufacturers list the “maximum permissible inflation pressure” on the tire sidewall. This number is the greatest amount of air pressure that can ever be put in the tire under normal driving conditions.

Checking Tire Pressure

It is important to check your vehicle’s tire pressure at least once a month for the following reasons:

- Most tires naturally lose air over time.
- Tires can lose air suddenly if you drive over a pothole or other object, or if you strike the curb when parking.
- With radial tires, it is usually not possible to determine under-inflation by visual inspection.

For convenience, purchase a tire pressure gauge to keep in your vehicle. Gauges can be purchased at tire dealerships, auto supply stores, and other retail outlets.

The recommended tire inflation pressure that vehicle manufacturers provide reflects the proper psi when a tire is cold. The term cold does not relate to the outside temperature. Rather, a cold tire is one that has not been driven on for at least three hours. When you drive, your tires get warmer, causing the air pressure within them to increase. Therefore, to get an accurate tire pressure reading, you must measure tire pressure when the tires are cold or compensate for the extra pressure in warm tires.

Steps for Maintaining Proper Tire Pressure

Locate the recommended tire pressure on the vehicle’s tire information placard, certification label, or in the owner’s manual.

Record the tire pressure of all tires.

If the tire pressure is too high in any of the tires, slowly release air by gently pressing on the tire valve stem with the edge of your tire gauge until you get to the correct pressure.

If the tire pressure is too low, note the difference between the measured tire pressure and correct tire pressure. These “missing” pounds of pressure are what you will need to add.

At a service station, add the missing pounds of air pressure to each tire that is under-inflated.

Check all the tires to make sure they have the same air pressure (except in cases in which the front and rear tires are supposed to have different amounts of pressure).

If you have been driving your vehicle and think that a tire is under-inflated, fill it to the recommended cold-inflation pressure indicated on your vehicle’s tire information placard or certification label.

While your tire might still be slightly under-inflated due to the extra pounds of pressure in the warm tire, it is safer to drive with air pressure that is slightly lower than the vehicle manufacturer’s recommended cold-inflation pressure than to drive with a significantly under-inflated tire. Since this is a temporary fix, do not forget to recheck and adjust the tire’s pressure when you can obtain a cold reading.

ROUTINE MAINTENANCE

Tire Size

To maintain tire safety, purchase new tires that are of the same size as the vehicle's original tires or another size recommended by the manufacturer. Look at the tire information placard, the owner's manual, or the sidewall of the tire you are replacing to find this information. If you have any doubt about the correct size to choose, consult with the tire dealer.

Tire Tread

The tire tread provides the gripping action and traction that prevent your vehicle from slipping or sliding, especially when the road is wet or icy. In general, tires are not safe and must be replaced when the tread is worn down to 1/16 of an inch. Tires have built-in tread-wear indicators that let you know when it is time to replace your tires. These indicators are raised sections spaced intermittently in the bottom of the tread grooves. When they appear "even" with the outside of the tread, it is time to replace your tires.

Another method for checking tread depth is to place a penny in the tread with Lincoln's head upside down and facing you. If you can see the top of Lincoln's head, you are ready for new tires.

Tire Balance and Wheel Alignment

To avoid vibration or shaking of the vehicle when a tire rotates, the tire must be properly balanced. This balance is achieved by positioning weights on the wheel to counterbalance heavy spots on the wheel-and-tire assembly. A wheel alignment adjusts the angles of the wheels so that they are positioned correctly relative to the vehicle's frame. This adjustment maximizes the life of your tires. These adjustments require special equipment and should be performed by a qualified technician.

Tire Rotation

Rotating tires from front to back and from side-to-side can reduce irregular wear (for vehicles that have tires that are all of the same size). Look in your owner's manual for information on how frequently the tires on your vehicle must be rotated and the best pattern for rotation.

Tire Repair

The proper repair of a punctured tire requires a plug for the hole and a patch for the area inside the tire that surrounds the puncture hole. Punctures through the tread can be repaired if they are not too large, but punctures to the sidewall should not be repaired. Tires must be removed from the rim to be properly inspected before being plugged and patched.

ROUTINE MAINTENANCE

A Tire Rotation Example

For maximum mileage, rotate your tires every 5,000 miles. Follow correct rotation patterns.

Six Tire Rotation

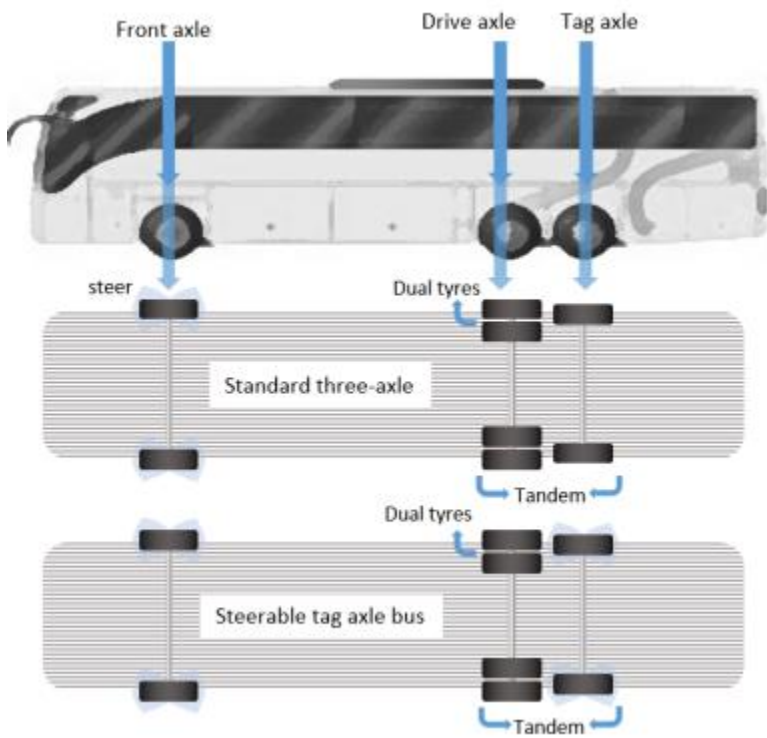
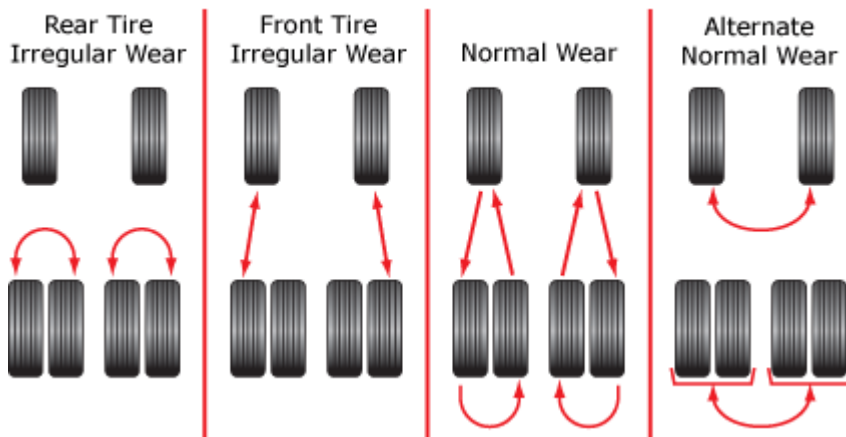

Three-axe diagram from the side and underneath perspectives

years.

Next

rim

size, you

new wheel number.

Next number—This two or three-digit number is the tire’s load index. It is a measurement of how much weight each tire can support. You might find this information in your owner’s manual. If not, contact a local tire dealer.

Information on Passenger Vehicle Tires

P—The “P” indicates the tire is for passenger vehicles.

NOTE: Passenger car tires are not recommended for use on trailers, because the capacity ratings are not marked on the side walls of these tires. In the event that a passenger car tire is used, the capacity must be de-rated by 10%.

Next number—This three-digit number gives the width in millimeters of the tire from sidewall edge to sidewall edge. In general, the larger the number, the wider the tire.

Next number—This two-digit number, known as the aspect ratio, gives the

mation

tire’s ratio of height to width. Numbers of 70 or lower indicate a short sidewall for improved steering response and better overall handling on dry pavement.

R—The “R” stands for radial. Radial ply construction of tires has been the industry standard for more than 20

number—This two-digit number is the wheel or diameter in inches. If you change your wheel will have to purchase new tires to match the

ROUTINE MAINTENANCE

NOTE: You might not find this information on all tires because it is not required by law.

M+S—The “M+S” or “M/S” indicates that the tire has some mud and snow capability. Most radial tires have these markings.

TIRE SIDEWALL MARKINGS

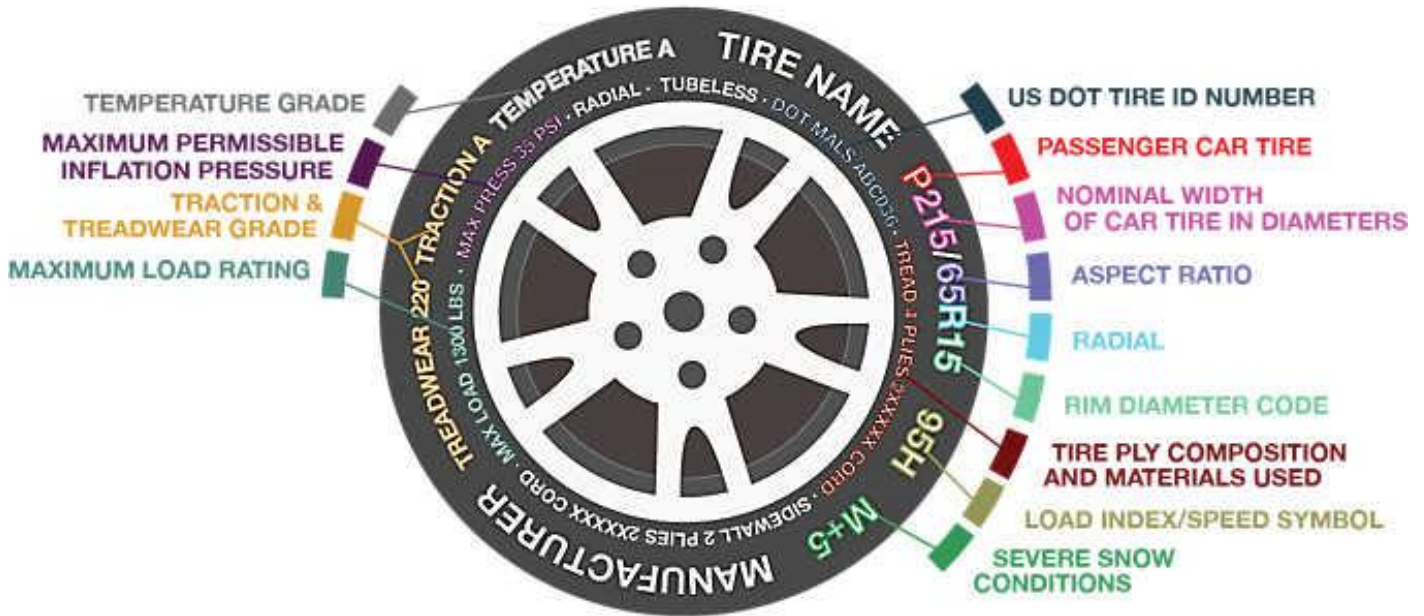

Speed Rating—The speed rating denotes the speed at which a tire is designed to be driven for extended periods of time.

U.S. DOT Tire Identification Number—This begins with the letters “DOT” and indicates that the tire meets all federal standards. The next two numbers or letters are the plant code where it was manufactured, and the last four numbers represent the week and year the tire was built. For example, the numbers 1612 means the 16th week of 2012. The other numbers are marketing codes used at the manufacturer’s discretion. This information is used to contact customers if a tire defect requires a recall.

Tire Ply Composition and Materials Used—The number of plies indicates the number of layers of rubber-coated fabric in the tire. In general, the greater the number of plies, the more weight a tire can support. Tire manufacturers also must indicate the materials in the tire, which include steel, nylon, polyester, and others.

Maximum Load Rating—This number indicates the maximum load in kilograms and pounds that can be carried by the tire.

Maximum Permissible Inflation Pressure—This number is the greatest amount of air pressure that should ever be put in the tire under normal driving conditions.

Vehicle Load Limits

Determining the load limits of a vehicle includes more than understanding the load limits of the tires alone. On a motor home, there is a federal certification label that is affixed in the rear closet. The

ROUTINE MAINTENANCE

certification label will indicate the vehicle's gross vehicle weight rating (GVWR). This is the most weight the fully loaded vehicle can weigh.

It will also provide the gross axle weight rating (GAWR). This is the most a particular axle can weigh. If there are multiple axles, the GAWR of each axle will be provided. For motor homes, in the same location as the certification label described above, there is a vehicle placard in the entry doorframe. This placard provides tire and loading information. In addition, this placard will show the vehicle's seating capacity for people and a statement regarding maximum cargo capacity.

Cargo Capacities

For motor homes, cargo can be added to the vehicle, up to the maximum weight specified on the placard. For motorized vehicles, the combined weight of passengers and cargo is provided as a single number. If fewer people are traveling, more cargo can be added. If more people are involved, the weight of cargo must be reduced. In any case, the total weight of a fully loaded vehicle, including passengers, cannot exceed the stated GVWR.

For motor homes, the water and propane also need to be considered. The weight of fully filled propane containers is considered part of the weight of the RV before it is loaded with people or cargo and is not considered part of the disposable cargo load. Water, however, is a cargo weight and is treated as such. If there is a fresh water storage tank of 50 gallons, this tank when filled would weigh about 400 pounds. If more cargo or people are being transported, water can be off-loaded to keep the total amount of cargo added to the vehicle within the limits of the GVWR to not overload the vehicle.

Understanding this flexibility will allow you to make choices that fit your travel and camping needs. When loading your cargo, be sure it is distributed evenly to prevent overloading from front to back and side-to-side. Heavy items should be placed low and as close to the axle positions as reasonable. Too many items on one side might overload a tire.

The best way to know the actual weight of the vehicle is to weigh it at a certified public scale. Talk to your RV dealer to discuss the weighing methods needed to determine the various weights related to the RV. This will include weights for axles, wheels, hitch, and total weight.

How Overloading Affects Your RV and Tires

The results of overloading can have serious consequences for passenger safety. Too much weight on your vehicle's suspension system can cause spring, shock absorber, or brake failure, handling or steering problems, irregular tire wear, tire failure, or other damage.

An overloaded vehicle is hard to drive and hard to stop. In cases of serious overloading, brakes can fail completely, particularly on steep hills. The load a tire will safely carry is a combination of the size of tire, its load range, and corresponding inflation pressure.

Excessive loads and/or under-inflation cause tire overloading and, as a result, abnormal tire flexing occurs. This situation can generate an excessive amount of heat within the tire. Excessive heat might lead to tire wear and eventually, tire failure.

It is the air pressure that enables a tire to support the load, so proper inflation is critical. Since RVs can be configured and loaded in many ways, air pressures must be determined from actual loads (determined by weighing) and taken from the load and inflation tables provided by the tire manufacturer. These air

ROUTINE MAINTENANCE

pressures might differ from those found on the certification label. However, they should never exceed the tire limitation for load or air pressure.

Tire Safety Tips

Preventing Tire Damage

- Slow down if you have to go over a pothole or other object in the road.
- Do not run over curbs or other foreign objects in the roadway, and try not to strike the curb when parking.

Tire Safety Checklist

- ✓ Check tire pressure regularly (at least once a month), including the spare.
- ✓ Inspect tires for uneven wear patterns on the tread, cracks, foreign objects, or other signs of wear or trauma.
- ✓ Remove bits of glass and foreign objects wedged in the tread.
- ✓ Make sure your tire valves have valve caps.
- ✓ Check tire pressure before going on a long trip.
- ✓ Do not overload your vehicle. Check the Tire Information and Loading Placard or User's Manual for the maximum recommended load for the vehicle.

ROUTINE MAINTENANCE

SECTION TWO

Steps for Determining Correct Load Limit

Locate the statement “The combined weight of occupants and cargo should never exceed XXX lbs” on your vehicles placard.

Determine the combined weight of the driver and passengers that will be riding in your vehicle.

Subtract the combined weight of the driver and passengers from XXX kilograms or XXX pounds.

The resulting figure equals the available amount of cargo and luggage capacity. For example, if “XXX” equals 1400 lbs. and there will be five 150 lb. passengers in your vehicle, the amount of available cargo and luggage capacity is 650 lbs. $(1400 - 750 (5 \times 150) = 650 \text{ lbs.})$

Determine the combined weight of luggage and cargo being loaded on the vehicle. That weight may not safely exceed the available cargo and luggage capacity calculated in Step #4.

If your vehicle will be towing a trailer, load from your trailer will be transferred to your vehicle. Consult this section to determine how this reduces the available cargo and luggage capacity of your vehicle.

SECTION THREE

Glossary of Tire Terminology

Accessory weight—The combined weight (in excess of those standard items, which may be replaced) of automatic transmission, power steering, power brakes, power windows, power seats, radio and heater, to the extent that these items are available as factory-installed equipment (whether installed or not).

Bead—The part of the tire that is made of steel wires, wrapped or reinforced by ply cords and that is shaped to fit the rim.

Bead separation—This is the breakdown of the bond between components in the bead.

Bias ply tire—A pneumatic tire in which the ply cords that extend to the beads are laid at alternate angles substantially less than 90 degrees to the centerline of the tread.

Carcass—The tire structure, except tread and sidewall rubber which, when inflated, bears the load.

Chunking—The breaking away of pieces of the tread or sidewall.

Cold-inflation pressure—The pressure in the tire before you drive.

Cord—The strands forming the plies in the tire.

Cord separation—The parting of cords from adjacent rubber compounds.

Cracking—Any parting within the tread, sidewall, or inner liner of the tire extending to cord material.

CT—A pneumatic tire with an inverted flange tire and rim system in which the rim is designed with rim flanges pointed radially inward and the tire is designed to fit on the underside of the rim in a manner that encloses the rim flanges inside the air cavity of the tire.

ROUTINE MAINTENANCE

Curb weight—The weight of a motor vehicle with standard equipment including the maximum capacity of fuel, oil, and coolant, and, if so equipped, air conditioning and additional weight optional engine.

Extra load tire—A tire designed to operate at higher loads and at higher inflation pressures than the corresponding standard tire.

Groove—The space between two adjacent tread ribs.

Gross Vehicle Weight Rating (GVWR)—The maximum permissible weight of this fully loaded motor home.

Gross Axle Weight Rating (GAWR)—The value specified as the load carrying capacity of a single axle system, as measured at the tire-ground interfaces.

Hitch Weight—The vertical trailer load supported by the hitch ball.

Innerliner separation—The parting of the innerliner from cord material in the carcass.

Intended outboard sidewall—The sidewall that contains a white-wall, bears white lettering or bears manufacturer, brand, and/or model name molding that is higher or deeper than the same molding on the other sidewall of the tire or the outward facing sidewall of an asymmetrical tire that has a particular side that must always face outward when mounted on a vehicle.

Light truck (LT) tire—A tire designated by its manufacturer as primarily intended for use on light-weight trucks or multipurpose passenger vehicles.

Load rating—The maximum load that a tire is rated to carry for a given inflation pressure.

Maximum load rating—The load rating for a tire at the maximum permissible inflation pressure for that tire.

Maximum permissible inflation pressure—The maximum cold-inflation pressure to which a tire may be inflated.

Maximum loaded vehicle weight—The sum of curb weight, accessory weight, vehicle capacity weight, and production options weight.

Measuring rim—The rim on which a tire is fitted for physical dimension requirements.

Non-pneumatic rim—A mechanical device which, when a non-pneumatic tire assembly incorporates a wheel, supports the tire, and attaches, either integrally or separably, to the wheel center member and upon which the tire is attached.

Non-pneumatic tire assembly—A non-pneumatic tire, alone or in combination with a wheel or wheel center member, which can be mounted on a vehicle.

Normal occupant weight—This means 68 kilograms (150 lbs.) times the number of occupants specified in the second column of Table I of 49 CFR 571.110.

Occupant distribution—The distribution of occupants in a vehicle as specified in the third column of Table I of 49 CFR 571.110.

Open splice—Any parting at any junction of tread, sidewall, or innerliner that extends to cord material.

Outer diameter—The overall diameter of an inflated new tire.

ROUTINE MAINTENANCE

Overall width—The linear distance between the exteriors of the sidewalls of an inflated tire, including elevations due to labeling, decorations, or protective bands or ribs.

Pin Weight—The vertical trailer load supported by the king pin of a fifth wheel hitch.

Ply—A layer of rubber-coated parallel cords.

Ply separation—A parting of rubber compound between adjacent plies.

Pneumatic tire—A mechanical device made of rubber, chemicals, fabric and steel, or other materials, that, when mounted on an automotive wheel, provides the traction and contains the gas or fluid that sustains the load.

Production options weight—The combined weight of those installed regular production options weighing over 2.3 kilograms (5 lbs.) in excess of those standard items which they replace, not previously considered in curb weight or accessory weight, including heavy duty brakes, ride levelers, roof rack, heavy duty battery, and special trim.

Radial ply tire—A pneumatic tire in which the ply cords that extend to the beads are laid at substantially 90 degrees to the centerline of the tread.

Recommended inflation pressure—This is the inflation pressure provided by the vehicle manufacturer on the Tire Information label and on the Certification/VIN tag.

Reinforced tire—A tire designed to operate at higher loads and at higher inflation pressures than the corresponding standard tire.

Rim—A metal support for a tire or a tire and tube assembly upon which the tire beads are seated.

Rim diameter—This means the nominal diameter of the bead seat.

Rim size designation—This means the rim diameter and width.

Rim type designation—This means the industry of manufacturer's designation for a rim by style or code.

Rim width—This means the nominal distance between rim flanges.

Section width—The linear distance between the exteriors of the sidewalls of an inflated tire, excluding elevations due to labeling, decoration, or protective bands.

Sidewall—That portion of a tire between the tread and bead.

Sidewall separation—The parting of the rubber compound from the cord material in the sidewall.

Test rim—The rim on which a tire is fitted for testing, and may be any rim listed as appropriate for use with that tire.

Tread—That portion of a tire that comes into contact with the road.

Tread rib—A tread section running circumferentially around a tire.

Tread separation—Pulling away of the tread from the tire carcass.

Treadwear indicators (TWI)—The projections within the principal grooves designed to give a visual indication of the degrees of wear of the tread.

ROUTINE MAINTENANCE

Vehicle capacity weight—The rated cargo and luggage load plus 68 kilograms (150 lbs.) times the vehicle's designated seating capacity.

Vehicle maximum load on the tire—The load on an individual tire that is determined by distributing to each axle its share of the maximum loaded vehicle weight and dividing by two.

Vehicle normal load on the tire—The load on an individual tire that is determined by distributing to each axle its share of the curb weight, accessory weight, and normal occupant weight (distributed in accordance with Table I of CFR 49 571.110) and dividing by 2.

Weather side—The surface area of the rim not covered by the inflated tire.

Wheel center member—In the case of a non-pneumatic tire assembly incorporating a wheel, a mechanical device which attached, either integrally or separable, to the non-pneumatic rim and provides the connection between the non-pneumatic rim and the vehicle; or, in the case of a non-pneumatic tire assembly not incorporating a wheel, a mechanical device which attaches, either integrally or separably, to the non-pneumatic tire and provides the connection between tire and the vehicle.

TIRE PRESSURE

Correct tire inflation pressure is essential to maximizing the life of the tires and assuring the safety of the vehicle and its occupants. Driving with tires that are not correctly inflated for the load of the motor home is dangerous and might cause premature wear, tire damage, and/or loss of control of the motor home.

An underinflated tire will build up excessive heat that might actually approach the vulcanization temperature of the rubber and lead to tread separation and/or disintegration of the tire.

Underinflated tires will also cause poor handling of the motor home, rapid and/or irregular tire wear, and an increase in rolling resistance of the motor home which, in turn, produces a decrease in fuel economy of operation.

An overinflated tire will reduce the tire's "footprint" (i.e., its actual contact with the road); thus, reducing the traction, braking capacity, and handling of the motor home. A tire that is over-inflated for the load that it is carrying will also contribute to a harsh ride, uneven tire wear, and the tire itself will be more susceptible to impact damage.

Maintaining correct tire pressure for each loaded wheel position on the motor home is critically important and must be a part of regular vehicle maintenance.

Tire Maximum Load Rating

Federal law requires that the maximum load rating be molded into the sidewall of the tire. If you look at a tire sidewall, you might see some "typical" information, such as:

Max. Load Single 3640 Lbs. at 85-psi cold

Max. Load Dual 3415 Lbs. at 85-psi cold

The maximum load allowed for the size of the tire and load rating and the minimum cold air-inflation pressure needed to carry that stated maximum load are noted on the tire. Using less air pressure would reduce the load-carrying capacity of the tire.

ROUTINE MAINTENANCE

NOTE: The amount of air pressure you need depends on the weight of the fully loaded motor home. You cannot determine the correct air-inflation pressure, unless you know the actual weights of the motor home.

Weighing the Motor home

Earlier, in Chapter 1, the procedures for weighing the motor home were presented. These procedures provided the weighing of a “non-loaded” (i.e., not stocked with the possessions and provisions the user would normally have onboard for travel) motor home. Obviously, any additional weight stored onboard (inside and underneath) the motor home will contribute to the overall weight of the motor home.

If not stored uniformly throughout the motor home, additional weight of the possessions and provisions of the motor home user will load each axle and each tire differently (front-to-rear and side-to-side distribution of that additional weight). Accordingly, **it is necessary to weigh the motor home fully loaded as the user would have it for travel.** Moreover, **it is necessary to weigh each tire position individually.**

Overloading the motor home can produce problems with the tires, wheels, springs, brakes, drive train, and other motor home assemblies. In addition, an overloaded motor home uses more fuel, is more difficult to handle properly, and can lead to driver fatigue more quickly. In a worst-case condition, if any component should fail, this could result in loss of control of the motor home and subsequent damage.

In certain states, the Highway Patrol routinely weighs motor homes to check for overloaded axle weights. Therefore, there are many good reasons for assuring that the motor home is properly loaded and not overloaded—this can be accomplished through a proper weighing of the fully loaded motor home.







You can find various places that have certified public scales where your motor home can be weighed. For example, moving and storage company lots, farm suppliers with grain elevators, gravel pits, recycling companies, and large-scale commercial-truck stops are some of the possible locations for weighing the motor home. You can also check the Yellow Pages of the telephone book for “scales – public” or “weighers” to determine other locations for weighing the motor home.

ROUTINE MAINTENANCE

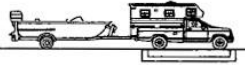
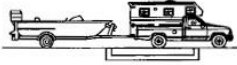
A brief overview of the procedure for weighing the motor home

WEIGHING YOUR SINGLE AXLE RECREATIONAL VEHICLE

RV: To Obtain Individual Axle and Gross Vehicle Weights:

	STEP 1a	STEP 1b	STEP 1c	STEP 1d
				
				
Scale Weight	_____ lbs.	_____ lbs.	_____ lbs.	_____ lbs.
	(Step 1a = GAW)	(Step 1b = GVW)	(Step 1c = GAW)	(Step 1d)
From Owner's Manual	_____ lbs.	_____ lbs.	_____ lbs.	_____ lbs.
	GAWR	GVWR	GAWR	Vehicle Weight (GCWR-GVW)

To Obtain Individual Wheel Position Weights:

	STEP 2a	STEP 2b	STEP 2c
			
One Side Scale Weight	_____ lbs.	_____ lbs.	_____ lbs.
	(Step 2a)	(Step 2b)	(Step 2c)
Calculate Other Side Weight	_____ lbs.	_____ lbs.	_____ lbs.
	(Step 1a-2a)	(Step 1b-2b)	(Step 1c-2c)
Tire Load (lbs.)	_____ lbs.	_____ lbs.	_____ lbs.
	(See Note #1)		(See Notes #1 & 2)
Inflation	_____ psi		_____ psi
	(See Note #1)		(See Note #1)

Figure 15-3: Motor home Weighing Procedures

NOTE: Tire manufacturer's load and inflation tables can be found on the sidewall of the tires mounted on the motor home.

NOTE: If the motor home has duals, read dual capacity from the tire and multiply by 2 (two) to obtain dual-assembly load-carrying capacity.

More detailed information can be found in the manufacturer's literature associated with the chassis and/or the tires provided with the motor home. For example, the above graphic illustrates the inflation pressures for Michelin tires as a function of the loads per position for a specified speed of the motor home. You can determine the appropriate inflation pressures for each of the tires on the motor home, as a function of the loads they are to carry on a trip. Whenever there is a significant change in the loading regimen of the motor home, it would be wise to re-calculate the load weights of the tires to ensure optimal use of the motor home.

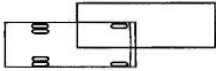
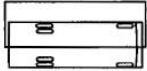
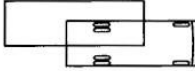
ROUTINE MAINTENANCE

Frequency of Checking Tire Inflation Pressures

When you have determined the “correct” tire inflation pressures for each of the motor home tires (Figure 15-4 and Figure 15-5) and inflated the tires under “cold” conditions, meaning the tires have not been driven for more than one mile, then the air pressures in the tires must be periodically checked to make sure that they retain their proper pressures. It is recommended that tire pressures be checked at least once a month, or preferably, every two weeks, and before any major trip.

On long trips, the tires should be checked every “drive” morning. On short trips (a day or less), the tires should be checked before one departs on the trip and again before one returns home.

Check tire pressures when they are “cold”; that is, the tires haven’t been driven at all or, at most, less than one mile before being measured. In this manner, the tire pressure has not been increased by the heating associated with tire sidewall and tread flexure associated with traveling. If you check tires that are warm or hot, remember that they will necessarily read higher than normal. Do not “bleed” these tires down to the “cold pressure” readings, as they will probably then be underinflated when they are actually cool.

Do not make any adjustments to tire pressures when the tires are warm or hot, if such can be avoided. To make these tire-pressure measurements, purchase a high-quality truck-tire air gauge, which has an angled dual head. This type of gauge enables you to check inflation pressures of both the inner dual wheel, which has the valve stem pointing toward one, and on the outer wheel, which has the valve stem pointing away from one.



Figure 15-4: Rear Tire



Figure 15-5: Front Tire

Pressure-sealing valve caps should always be used to protect the valve stems and prevent air from escaping from the valve stems.

Tire Wear, Balance, and Wheel Alignment

In addition to tire inflation considerations, the tires should also be periodically examined for other types of normal “wear and tear.” If installed and maintained properly, all tires mounted on the motor home will wear in a smooth, even pattern. If the tires begin to show irregular wear patterns and the motor home alignment is still correct, then sometimes just rotating the tires by changing wheel position and rotation of the tires will allow the tires to wear evenly.

ROUTINE MAINTENANCE

Check with the chassis manufacturer (Power Glide) and its literature in the Owner's Information Package for particulars on maintaining proper wheel alignment.

Tire Cleaning

Proper cleaning of the tires will ensure maximum years of service. A soft brush and the normal mild soap must be used to clean the tires. Use care in applying any tire "dressing" product as these contain petroleum derivatives, alcohol, or silicones, which might cause deterioration of the rubber, possibly leading to cracking, and accelerate the aging process. In many instances, it is not the actual dressing itself, but the reaction of that product with the antioxidant in the tire. Heat can also compound this problem.

INTERIOR CARE

NOTICE

The fading of upholstery, carpet, and other interior fabrics is generally caused by excessive sunlight. The drapes, blinds, or other shades must be kept closed when the vehicle is parked for an extended period of time to minimize the fading. Normal deterioration of the appearance of such items caused by wear and/or exposure to strong lighting is not covered by the Tiffin Motor homes Limited Warranty.

Carpet

A weekly routine of vacuuming the carpet and fabrics throughout the vehicle is recommended. The vacuum system has a central connection within the motor home wherein a vacuum hose can be connected and the necessary vacuuming performed, as desired.

Remember to empty or replace vacuum bags before they become overly full — this practice will ensure that sufficient vacuuming capability is readily available to handle all cleaning situations that might arise. In carpet areas that receive the most sunlight, keeping the curtains closed whenever possible will minimize fading. Also, act quickly when anything is spilled or dropped onto the carpet to prevent or minimize staining.

To connect the cleaning hose, raise the wall remote inlet valve door and align hose-end coupling with the slots on each side of the intake opening. Firmly push into the intake opening. Make sure the hose-end coupling is connected and is locked in place. To disconnect the hose, push in the slots on each side of the hose coupling and pull the hose end straight out.

ROUTINE MAINTENANCE

NOTE: The vacuum cleaner hose must be plugged into the outlet to activate the vacuum motor.

To start the vacuum cleaner:

Lift inlet valve cover on the wall.

Insert the hose cuff with a twist and push. The vacuum cleaner will start automatically.

To remove, turn the hose in either direction while pulling the hose toward you.

To change the dust bag, you will need to open the door on the vacuum cleaner by pushing the latch upward and removing the door completely. Remove the full bag and discard. Next, locate the pipe inside the vacuum chamber. Holding the new bag's cardboard collar at approximately a 45-degree angle, insert the cardboard part of the bag against the upper back of the vacuum cleaner chamber behind the pipe. Lift the front of the collar over the pipe as far as possible.

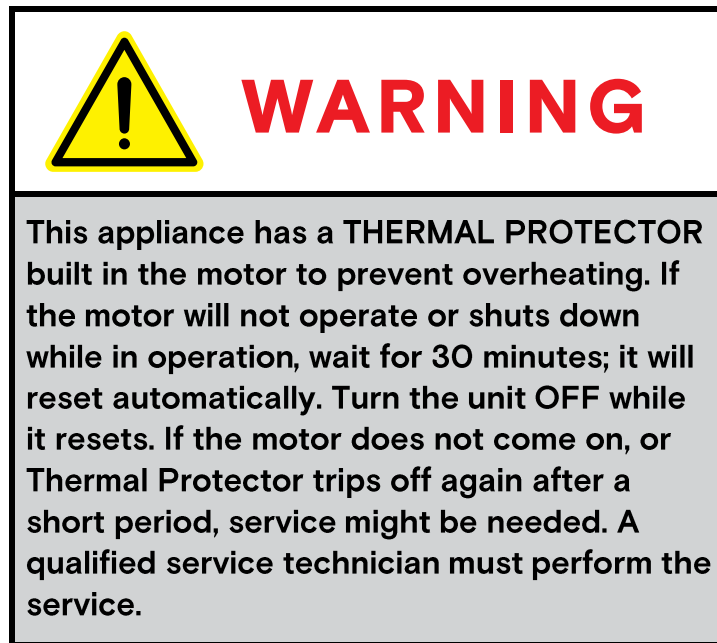

When closing the door, tuck in the left and right corners of the bag so that the door is properly sealed and the latch clicks into place. The vacuum cleaning system comes with an array of attachments that can be connected to the hose ends for extensive cleaning purposes. Make sure they are firmly pushed in, and twist to hold in place.

For further instructions to change the dust bag, use the attachments, and proper cleaning technique, refer to the specific Owner's Manual located in your motor home.

ROUTINE MAINTENANCE

FABRICS

The fabrics (Figure 15-6 and Figure 15-7), used in this Tiffin motor home for the bedspread, draperies, headboard, and valances contain fire-retardant additives that might be damaged by use of improper cleaning products.

These items are DRY CLEAN ONLY. Water-based products are not recommended for cleaning the fabrics in your new vehicle. Most water-based, household-cleaning products are not formulated for use on these fabrics and might cause excessive shrinkage or fading. For best results, the fabrics in this vehicle should be cleaned by a professional carpet and upholstery cleaner.



Figure 15-6: Furniture Fabrics



Figure 15-7: Bedroom Fabrics

Spills, spots, or stains should be treated as soon as possible to avoid permanent damage to the fabrics. If a spill occurs, blot the fluid with a dry towel, do not rub the spill as rubbing might cause the liquid to “set” in the fabric and cause a stain. When attempting to clean a spot or stain, always start from the outside and work inward to avoid spreading the stain further. Some stains or soils are extremely difficult or impossible to be removed completely. These stains should receive immediate professional attention. Spills, spots, stains, or soiled areas are the responsibility of the owner and are not covered by Tiffin Motor homes Limited Warranty.



WARNING

When cleaning the upholstery and fabric of the motor home, do not use lacquer thinner, nail polish remover, laundry soaps, or bleach. Never use carbon tetrachloride or gasoline for cleaning purposes. These substances might cause damage to the materials being cleaned and most are highly flammable.

ROUTINE MAINTENANCE

WALLS & CEILING

The wall and ceiling coverings should be cleaned periodically to maintain a new appearance. Use a non-abrasive cleaner with a soft cloth on the walls. Do not use solvents of any kind, as those solvents might damage the surfaces being cleaned.

DASHBOARD

To keep the motor home dashboard (Figure 15-8) in like-new condition, regularly follow these guidelines:

DOs

- Dust and clean the dashboard with a soft, damp cloth or chamois, wiping the service gently.
- Use a mild detergent and lukewarm water.
- After washing and rinsing the dashboard, dry it by blotting with a damp cloth or chamois.



Figure 15-8: Dashboard

DON'Ts

- Use harsh chemicals that might damage the dashboard.
- Use cloths containing grit or abrasive particles or kitchen-scouring compounds to clean or dust the dashboard.
- Subject the dashboard to hard, direct blows.
- Use boiling water, strong solvents, or other such materials to clean the dashboard, as they will soften the plastic.



Figure 15-9: Wood Cabinetry

WOODWORK & FLOORS

The wood cabinetry should be cared for with furniture polish to sustain the natural beauty and luster of the wood. This procedure will also keep the cabinetry (Figure 15-9) looking new, prevent the wood from drying, and reduce chances of accidental staining or aging.

Use area rugs and floor mats by the entrance door to trap dirt.

Use soap and water to clean the flooring, begin by vacuuming the floor to remove loose dust and dirt. Then, damp mop the floor with a cleaning solution consisting of

ROUTINE MAINTENANCE

any standard cleaning solution. The mop should be damp, but not dripping. For further tips, see the manufacturer's information sheet in your Tiffin Motor homes Owners Information Package.

COUNTERTOPS

To care properly for the countertops in your new vehicle, always use a heat pad or trivet to protect the surface from hot objects that might mar or damage the countertop surface. Hot pans and heat-producing appliances (such as electric skillets), when set directly on top of the countertop, can possibly mar the beauty and finish of the product.

Additionally, since heat-producing appliances can also damage countertop seams, it is essential to check with Tiffin Motor homes to identify seam locations to avoid them during subsequent use of the motor home. Although solid surfacing is repaired easily, certain steps must be taken to protect it.



Figure 15-10: Kitchen Countertops

Be sure to use a cutting board, rather than cutting directly on the countertop (Figure 15-10) surfaces. Although minor scratches and cuts can be repaired, a little care will ensure that the counter-top surfaces will keep looking new for years.

Avoid using harsh chemicals on the countertop. Wipe the countertop with a damp cloth to remove water spots. For most dirt and stains, wipe with a damp cloth and use soapy water or ammonia-based cleaners (e.g., Windex). If a stain does not respond to soap and water, for a matte finish, apply an abrasive cleanser and buff it with a Scotch-Brite pad, using a circular motion. Use the same technique in the case of a cigarette burn. If the finish is a gloss finish, contact the dealer for specific cleaning instructions.

Do not expose the surface to harsh chemicals, such as paint remover, turpentine, nail polish remover, or any stove and drain cleansers. If these chemicals should come into contact with the countertop surfaces, immediately wash off these chemicals, using appropriate safety measures to avoid injury.

In the event of subsequent staining or spotting, sand the affected surface lightly with fine sandpaper (400 grit or finer), then buff in a circular motion with a Scotch-Brite pad.

ACCESSORIES

The metallic light fixtures, bath accessories, and faucets can be cleaned by wiping with a soft, damp cloth. Washing with warm water will remove dry water spots. Polishing those fixtures with a soft cloth will also enhance their appearance. Do not use cleaners that contain harsh or abrasive chemicals. Alcohol or other similar solvents should never be used.

ROUTINE MAINTENANCE

DETECTORS

The CO/LP gas detectors (Figure 15-11) are self-contained and DO NOT require any maintenance other than normal cleaning and periodic testing. The smoke detector installed in the motor home is a 9 volt, battery-operated detector. The CO/LP gas detector is wired directly to the house batteries.

The batteries in the smoke detector need to be tested periodically and replaced when necessary. When cleaning the case on any of the detectors, use a damp cloth or paper towel. Do not spray cleaners or wax directly into the case as this action might cause false alarms or hinder the normal operation of the detectors.

Tiffin Motor homes recommends purchasing an inexpensive battery tester. This tester will allow checking of the batteries in the various alarms, any flashlights used in the motor home, and batteries in other appliances, which might be in the motor home during travels.

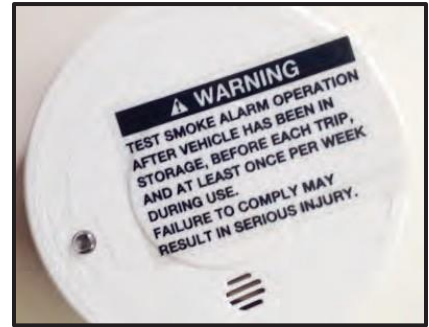

Figure 15-11: Smoke Detector

CONDENSATION

NOTICE

Since surface condensation within the motor home cannot be controlled by the manufacturer, damage caused by condensation is not covered by the Tiffin Motor homes Limited Warranty.

Damage might occur to your vehicle if excessive condensation exists. Accumulation of condensation on surfaces within your motor home occurs when warm, moist air contacts a cool surface. It is most evident on the inside of windows, but this problem can be controlled by:

Slightly opening a window or roof vent to allow the moisture to escape from the motor home.

Using a small dehumidifier to remove moisture from the air.

Condensation levels are highest during times when a person is cooking or taking a shower in the motor home, but these occasions are not the only times that condensation is present. Walls and ceiling panels might become wet when the moisture accumulates on these surfaces. Tiffin Motor homes does not recommend the use of any catalytic heaters because of resulting extensive condensation.

ROUTINE MAINTENANCE

ROUTINE MAINTENANCE SCHEDULES

NOTICE

Always follow the chassis maintenance guidelines outlined in the chassis manufacturer's owner's manual.

All routine maintenance is the responsibility of the owner and is not covered by the Tiffin Motor homes Limited Warranty. Use the maintenance record in Chapter 16 to record all performed maintenance as required.

Any damage caused by improper or unperformed maintenance is not covered by the Tiffin Motor homes Limited Warranty. Items supplied by other manufacturers might require specific individual maintenance not listed herein. Refer to the manufacturers' suggested maintenance guidelines in the Owners Information Package.

NOTICE

Cosmetic adjustments and alignments must be performed within the first three months from the date of original purchase for warranty consideration. Thereafter, these items are considered routine maintenance.

Monthly

- Check the water levels of the batteries.

Every Three Months

- Check LP gas lines for leaks with soap solution or leak detector.
- Clean the microwave hood exhaust fan filter and blades.
- Test smoke alarm and carbon monoxide/LP gas detector.
- Check operation of windows, latches, and hinges.
- Clean the roof-ducted air conditioner filters.
- Clean and inspect door and window seals; reseal where necessary.
- Inspect and reseal around the tub and shower area where necessary.
- Lubricate the exterior door hinges and latches with a graphite (silicone) lubricant.
- Check, clean, and tighten battery cables and inspect batteries for proper fluid levels.

ROUTINE MAINTENANCE

Every Six Months

- Inspect the slide-out for proper seal. If realignment is necessary, contact an authorized Tiffin Motor homes Service Center.
- Inspect the exterior rubber slide-out seals and apply a UV inhibitor, such as 303 Protectant.
- Change the battery in the smoke detector.
- Rotate tires as recommended by the tire manufacturer.
- Check all gas appliances for proper operation.
- Have the LP system inspected by a qualified technician.
- Lubricate the movable parts on the entrance step.
- Change the batteries in both the smoke detectors.
- For the washer/dryer, inspect the water hoses (both the hot and cold supply lines) to note any bulges, kinks, cuts, wear, or leaks. Especially note the hot-water hose, as this tends to degrade faster than the cold-water hose. Replace if hose feels “soft” or “spongy.”

Annually

- Inspection of roof seams and joints should be performed by an authorized Motor homes Service Center. If resealing is necessary, it is the owner’s responsibility and is not covered by the Tiffin Motor homes Limited Warranty.
- Sanitize the fresh water system.
- Wax and buff all gel-coat surfaces on the vehicle as described previously in this chapter.

WINTERIZING

To store your vehicle for the winter months, it is necessary to winterize the water system to help prevent freezing of this system. To do this, follow these instructions:

Drain all the water from the water system including the holding tanks and freshwater tank. Also, drain the water filter. For the holding tanks, open the gate valves to drain the tanks.

NOTE: This procedure is to be performed only at a wastewater pumping station to prevent dumping of contaminated water elsewhere.

Remove the filter cartridge from the water filter and store it in a clean environment. Empty any excess water from the filter housing and replace the housing.

Turn the by-pass valve located in the exterior sanitation compartment to the “by-pass” position to prevent filling the water heater tank with antifreeze.

Disconnect the inlet connection to the water pump located in the sanitary service compartment under the motor home. Attach the supplied vinyl hose (via the plastic coupling on the hose) to the inlet connection and hand-tighten that connection. Do not over-tighten.

ROUTINE MAINTENANCE

Place the other end of the hose into a gallon of freshwater system antifreeze (one can refer to the local Tiffin Motor homes dealer or representative for the freshwater antifreeze formulation for your specific area).

NOTE: Do not use automotive antifreeze; use only antifreeze approved for RV applications. Otherwise, damage to the systems being protected might result.

Turn ON the water pump to start the flow of antifreeze. Turn ON each faucet, one at a time and allow pure antifreeze to run through that piping. Let about one cup drop into the drains to protect the traps.

When all the antifreeze is withdrawn from the bottle, disconnect the clear vinyl hose from the water-pump inlet connection and reconnect the inlet line to the water pump. (This might require more than one gallon of antifreeze).

When the winterizing process is completed, turn the water pump OFF and then reconnect the water line. Store the vinyl hose for future use.

Open the water supply valve that controls flow from the pump to the tank to help prevent freezing on that water line.

NOTE: The motor home also has an exterior shower that must be winterized, as well.

If the motor home is equipped with an optional icemaker, the following additional steps should be taken.

Dometic Refrigerator Ice Maker

Shut off the water supply to the icemaker.

Place a shallow pan under the water solenoid valve.

Remove the inlet fitting to the icemaker water solenoid valve. Then, drain the water from the supply line.

Remove the plastic nut and water line from the outlet side of the water solenoid valve. Then, drain the water from that line.

NOTE: Do not lose the metal insert from the plastic water line. One recommended way to secure this insert is to place it into a "zip lock" bag, seal the bag, punch a small hole through the top of the bag above the zip-lock, insert any type of "twist-tie" through the hole, and then secure that bag to the outlet line for safekeeping.

Connect a source of compressed air (up to 20 psig) onto the inlet fitting of the water solenoid valve. Apply AC power to the solenoid valve for forcing the icemaker mold assembly through several harvest cycles.

Remove the plastic cover from the mold assembly. The bail arm must be in the DOWN (or ON) position.

Start the harvest cycle with a flat-blade screwdriver inserted into the center of the small gear.

ROUTINE MAINTENANCE

Turn the gear counter clockwise (CCW). When the hold switch closes, the mold assembly will continue to operate through the harvest cycle. During the water-fill sequence of the harvest cycle, the compressed air will blow out the water trapped in the solenoid valve.

Repeat the harvest cycle operation (i.e., steps 7 and 8) several times.

NOTE: Damage to the solenoid valve can occur if the AC power is applied for more than 20 seconds.

Reconnect and tighten the lines on the water solenoid valve. The metal insert must be installed in the plastic water line going to the outlet side of the water solenoid. Leave the water supply turned OFF until temperatures are above 0° F (-18° C).

Dry out the icemaker mold assembly with a soft cloth. Place the bail arm in the UP (OFF) position.

Whirlpool Residential Refrigerator Ice Maker

Unplug refrigerator or disconnect power.

Locate the water supply shut off valve and turn OFF the water supply.

Disconnect the water supply line at the refrigerator and drain the supply line completely.

Locate the icemaker fill tube at the rear of the refrigerator and follow the water line down to the water valve.

Remove any covers if necessary.

Disconnect the water line from the water valve, and drain the water from the line and the valve. Use a small pan to catch water.

Remove the water filter cartridge (if applicable.)

NOTE: Reinstall a new water filter cartridge when the refrigerator is put back into service.

DE-WINTERIZING

Open both of the low-point drains to allow the antifreeze solution to drain from the water system.

Close the low-point drains and connect your vehicle to the city water system. Put water in the freshwater tank and pump at least one gallon through the water pump to remove the antifreeze from the water pump. Keep the water heater in the bypass mode.

Open the kitchen faucet, bath faucet, inside and outside showers, turning ON both the hot and cold-water valves and flushing the stool until the antifreeze solution is flushed out of the system and the water flow is clear.

Open the water heater bypass valve. Open the freshwater tank supply valve from the pump and the icemaker valve.

Reinstall the water filter.

ROUTINE MAINTENANCE

Be sure to close the fresh water tank drain valves to allow the tank to fill.

ZEPHYR

MAINTENANCE & DATA CHARTS

Chapter

16

RV OWNER DATA SHEET

Enter the following information in the table for your future use:

Zephyr: Year: _____ Model # _____ Tiffin Serial# _____			
Appliance	Brand	Model No.	Serial No.
Refrigerator			
Aqua-Hot			
Microwave			
Inverter/Converter			
Television, Front			
Back-up monitor			
Stereo/CD			
DVD home theater			
Air conditioner			
Generator			

Reproduction Master – Copy this sheet and use copy to maintain your maintenance records. You might wish to keep the completed sheets in a three-ring binder for your permanent record.

RV OWNER MAINTENANCE RECORD

Enter the following information in the table for your future use:

Zephyr: Year: _____ Model # _____ Tiffin Serial# _____			
Date/Mileage	Work Performed	Performed by	Cost (\$)

Reproduction Master – Copy this sheet and use copy to maintain your maintenance records. You might wish to keep the completed sheets in a three-ring binder for your permanent record.

RV OWNER MAINTENANCE RECORD

Enter the following information in the table for your future use:

Zephyr: Year: _____ Model # _____ Tiffin Serial # _____			
Date/Mileage	Work Performed	Performed by	Cost (\$)

Reproduction Master – Copy this sheet and use copy to maintain your maintenance records. You might wish to keep the completed sheets in a three-ring binder for your permanent record.



TIFFIN

MOTORHOMES

Tiffin Motor homes, Inc. | 105 2nd St. NW | Red Bay, AL 35582
tiffinmotorhomes.com

Phone: 256-356-8661 | Email: customersupport@tiffinmotorhomes.com

To view or download a full color, printable version of this owner's manual, visit
www.tiffinmotorhomes.com/resources/owners-manual

OR SCAN BELOW

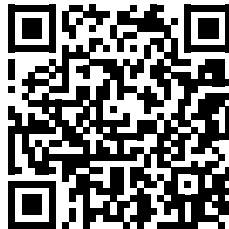

Because of progressive improvements and specifications, standard and optional equipment are subject to change without notice or obligation. For a complete and up-to-date list of available options and specifications, visit tiffinmotorhomes.com.

©2024 Tiffin Motor homes, Inc.

Allegro®, Allegro Breeze®, Allegro RED®, Phaeton®, Allegro Bus®, Zephyr®, Wayfarer®, Roughing It Smoothly®, Open Road®, PowerGlide®, and Cahaba® are registered trademarks of Tiffin Motor homes, Inc. All rights reserved.