



TIFFIN

MOTORHOMES

2024 Owner's Manual



WAYFARER



TIFFIN

MOTORHOMES

DISCLAIMER

Many of the features and appliances described in this manual might not be reflected in the actual motorhome purchased, depending on the options and models selected by the motorhome owner. All items, materials, instructions, and guidance described in this manual are as accurate as possible at the time of printing. However, due to Tiffin Motorhomes' ongoing and dedicated commitment to excellence, improvement of Tiffin's motorhomes is a continuing process. Consequently, Tiffin Motorhomes reserves the right to make substitutions and improvements in its makes and models of motorhomes without prior notification. Substitutions of comparable or better materials, finishes, appliances, instrumentation, and instruction might be made at any time it is deemed prudent to provide the customer with the best possible motorhome, meeting the customer's requirements.

Copyright © by Tiffin Motorhomes, Inc. - all rights reserved.

Tiffin Motorhomes, Inc. ©

105 2nd St. NW

Red Bay, AL 35582

Phone: 256-356-8661

Fax: 256-356-8219

Email: customersupport@tiffinmotorhomes.com

www.tiffinmotorhomes.com



TIFFIN

Many Adventures. One Dream.™



There are many ways to adventure in our products, but all customers share a similar dream of leisure, exploration, and fun while making lifelong memories with the most important people in their lives.

Our products are the vehicle for customer's adventures and helping them realize their dreams.

TABLE OF CONTENTS

1 General Information	1
Welcome to a life of “roughing it smoothly”	2
About This Manual	2
Delivery.....	3
Dealer Responsibilities	3
Customer Responsibilities	3
Reporting Safety Defects	4
Reporting Safety Defects (Canada)	4
Signalement Des Defauts De Securite A Transport Canada Pour Les Proprietaires Canadiens	5
Tiffin Motorhomes Limited Warranty	6
Major Equipment Manufacturers.....	6
Warranty Service	6
Owner’s Information Package.....	7
Customer Relations.....	7
Specification Labels	7
Weighing Procedures	9
Weight Distribution	9
2 Safety Instructions	10
Safety Messages	11
Safety Considerations	12
General Warnings	12
Pre-Departure Checklist.....	13
Driving Safety	14
Fuels for the Motorhome	15
Liquid Propane (LP) Gas System.....	16
LP Gas Regulator	18
LP Distribution System.....	18
Recommended Practices	19
Carbon Monoxide Warning	19
CO/LP Gas Detector	20
Fire Safety	22
Fire Extinguisher	22
Smoke Detector	23
Electrical	23
Loading	23
Maintenance.....	23
Emergency Exits	24
Parking Procedures	24
Towing Hitch	25

TABLE OF CONTENTS

3 Heating & Air Conditioning	26
FURNACE.....	27
AIR CONDITIONING SYSTEM	28
THERMOSTAT CONTROLS	29
HEAT PUMP CONTROLS.....	29
HOW THE HEAT PUMP THERMOSTAT WORKS.....	30
4 LP Gas System.....	31
LIQUID PROPANE (LP) TANK	32
LP TANK FILLING PRACTICES	33
LP GAS REGULATOR	33
5 Major Appliances	35
LP/GAS REFRIGERATOR.....	36
MICROWAVE OVEN	37
COOK TOP	38
WATER HEATER	40
LP Gas – Electronic Ignition Operation.....	40
120- VOLT AC ELECTRICAL OPERATION.....	40
WATER HEATER STORAGE	41
PRESSURE RELIEF VALVE	41
Truma AquaGo@ LP Gas Instant Water Heater.....	42
WARNING Scalding injuries caused by hot water!	44
How the appliance works	44
Starting the appliance.....	45
WARNING Danger of combustion, personal injury and damage to the RV!.....	46
Operating procedures	46
ECO.....	47
Comfort.....	47
NOTICE	48
NOTICE	48
Winterizing.....	49
Winterizing the appliance	49
Winterizing the RV with a winterizing fluid	49
Winterizing AquaGo basic /AquaGo comfort.....	49
Winterizing AquaGo comfort plus	50
6 Entertainment.....	52
Running the television(s) on inverter power for prolong periods of time will drain the motorhome batteries. ...	53
television(s)	53

TABLE OF CONTENTS

Radio control	53
7 Cabinets and Furniture	54
CABINETS.....	55
KITCHEN, LIVING & DINING AREAS	57
Sofa	57
Sleeping AREA.....	58
8 Structural Features	59
CHASSIS FEATURES	60
9 Electrical Features	61
GENERAL INFORMATION	62
ELECTRICAL FEATURES	62
CIRCUIT BREAKER BOXES	63
BATTERY DISTRIBUTION CENTER	63
BATTERY INSPECTION AND CARE	64
USB RECEPTACLES.....	66
ELECTRICAL GENERATOR	68
AUTOMATIC TRANSFER SWITCH	69
Electrical Diagram	72
25JW	72
10 Equalizer System	75
WARNINGS AND PRECAUTIONS	76
PARKING THE COACH.....	76
Equalizer Power Fuse Block.....	77
Equalizer System Controller.....	77
Equalizer System Control Switch.....	77
Extending the Stabilizers	78
Retracting the Stabilizers	78
11 Slide-Out Features	80
GENERAL CONSIDERATIONS.....	81
OPERATING PRECAUTIONS	82
12 Exterior Features.....	84
TOWING HITCH	85
SECURITY LIGHTS	86
ELECTRIC STEPS	86

TABLE OF CONTENTS

13 Interior Features.....	89
FLOORING	90
FLOORING in the Wayfarer.....	90
CEILING	90
WINDOW TREATMENTS.....	90
14 Plumbing & Bath Features	92
MONITOR PANEL.....	93
KITCHEN SINK.....	93
SINK, SHOWER & ACCESSORIES.....	93
WATER PUMP	94
CITY WATER CONNECTIONS	94
HOOKUP	95
WATER FILTER	97
WATER HEATER BYPASS SYSTEM	97
TOILET.....	98
BLACK WATER HOLDING TANK.....	99
GRAY WATER HOLDING TANK.....	99
WASTEWATER DISPOSAL	99
SEWER CONNECTION AND CAMPING.....	100
NO FUSS FLUSH	100
EXTERIOR SHOWER	101
Plumbing diagram	102
25JW	102
15 Windows, Awnings, Vents, & Doors	105
WINDOWS	106
AWNING.....	106
VENTS	108
DOORS.....	108
16 Driving Your Motorhome.....	109
SINGLE VISION CAMERA MONITOR SYSTEM.....	110
AM / FM / CD STEREO SYSTEM	110
DASHBOARD HEATING / COOLING CONTROLS	110
17 Routine Maintenance	111
Washing	112
Seals.....	113
Proper Sealants for Application.....	113
Wheel Care	114

TABLE OF CONTENTS

Roof Care & Maintenance	114
Moisture Management.....	115
Interior Care of Your RV	115
Control Relative Humidity	115
Avoid Drastic Thermostat Setbacks	116
Manage Window Condensation	116
Carpet Care and Moisture Management	116
Cleaning Tile and Wood Floors.....	116
Storage and Other Isolated Areas within the RV.....	116
Use of Un-Vented Combustion Equipment	116
Exterior Care of Your RV	117
Use of Your RV	117
Severe Environments	117
Storage of Your RV	117
Modifications to Your RV	118
Wet Areas	118
Tire & Safety Information	119
Section One	119
Section Two.....	127
Section Three	127
Tire Pressure	130
Interior Care	134
Fabrics.....	134
Walls & Ceiling	135
Dashboard	135
Woodwork & Floors	136
Countertops.....	136
Accessories.....	137
Detectors.....	137
Condensation	137
Routine Maintenance Schedules	138
Winterizing.....	140
De-Winterizing	142
18 Maintenance & Data Charts	143
RV Owner Data Sheet.....	144
RV Owner Maintenance Record	145

WAY FAREER

GENERAL INFORMATION

Chapter

1

WAY FAREER

WELCOME TO A LIFE OF “ROUGHING IT SMOOTHLY”

Tiffin Motorhomes is excited that you have entered the world of motorhome travel and we believe that you and your family will enjoy this way of life for years to come. Your Tiffin-built motorhome provides all the luxuries and comforts of home while allowing you to travel freely as you choose.



But, before heading out on the open roads, make yourself familiar with this owner’s manual to learn more about the operations of your motorhome. Also, work with your dealer to learn as much as possible about the functionality and features of your coach.

Tiffin Motorhomes – Made To Move You



And remember, *“wherever you go, we go.”*

ABOUT THIS MANUAL

Carefully read this manual to understand how everything in your motorhome works.

NOTE: This operator’s manual describes the features of your motorhome and includes instructions for their safe use. The manual, however, including its photography and illustrations, is of a general nature. Some equipment and features described in this manual might be optional or unavailable on your model.

The instructions included are meant to serve as a guide and in no way extend the responsibilities of Tiffin Motorhomes beyond the standard written warranty. The descriptions, illustrations, and specifications in this manual were correct at the time of printing and Tiffin Motorhomes reserves the right to change specifications or design without notice, and without incurring the obligation to install the same on products previously manufactured.

Many of the instruction sheets and manuals for the various appliances inside your motorhome have been incorporated into this manual for your convenience.

GENERAL INFORMATION



TIFFIN

MOTORHOMES

DELIVERY

Throughout the entire manufacturing process, your Tiffin motorhome has been regularly inspected by our qualified personnel to ensure that you receive the finest product of the highest quality. However, the final inspection at our factory is not the last one. The pre-delivery inspection and system check that your dealer perform are the final inspections before you receive your new motorhome. Your dealer is also available to assist you in understanding the warranties and completing the necessary forms to activate the warranties for the various appliances and accessories installed in your motorhome.

DEALER RESPONSIBILITIES

1. A **pre-delivery inspection and systems check** is performed to ensure a thorough inspection of the motorhome and the proper operation of all factory-installed components.
2. A **customer walk-through** is performed to familiarize the buyer with the motorhome, its systems and components, and their proper and safe operation.
3. Delivery of the **Owner's Information Package**, which contains warranty cards and registrations for the vehicle and all factory-installed components from other vendors and suppliers to Tiffin Motorhomes. The detailed operation and maintenance instructions on these components are also included in this package.
4. Assisting the customer in **completing the registration forms** to avoid loss of warranty coverage. The dealer will review the limited-warranty provisions with the customer and stress the importance of completing the warranty cards and registration forms for the components in the motorhome to enable the manufacturers to receive them within the prescribed time limits.
5. Providing the customer with **information regarding warranty and non-warranty work** on the vehicle and its separately warranted components.

CUSTOMER RESPONSIBILITIES

The customer is responsible for regular and proper maintenance of the motorhome. Properly maintaining your motorhome will prevent conditions arising from neglect that are not covered by your Tiffin Motorhomes limited warranty. The maintenance guidelines in this manual and any other applicable manuals must be followed. It is your responsibility and obligation to return the vehicle to an authorized dealer for repairs and service.

GENERAL INFORMATION

To assist you in avoiding problems with your motorhome, Tiffin Motorhomes recommends that you do the following:

1. **Read the warranty.** Go over it thoroughly with your dealer to make sure you understand all the terms and conditions of the warranty.
2. **Inspect the motorhome;** do not accept delivery until you have gone through the motorhome with the authorized Tiffin Motorhomes dealer.
3. **Ask questions** about anything you do not fully understand about your motorhome. Tiffin Motorhomes is here to serve you and ensure that you have all the information necessary for the safe and enjoyable use of your new motorhome.
4. When you are taking delivery, **set an appointment for adjustments.** This appointment must be within two weeks after you accept delivery.
5. You are responsible to **use your motorhome in a responsible, safe manner.** Take the time to familiarize yourself with the proper operation of the unit before you attempt to use it.

REPORTING SAFETY DEFECTS

575.6(a)(2)(i) At the time a motor vehicle manufactured on or after September 1, 1990 is delivered to the first purchaser for purposes other than resale, the manufacturer shall provide to the purchaser, in writing in the English language and not less than 10 point type, the following statement in the owner's manual, or, if there is no owner's manual, on a one-page document:

If you believe that your vehicle has a defect which could cause a crash or could cause injury or death, you should immediately inform the National Highway Traffic Safety Administration (NHTSA) in addition to notifying TIFFIN MOTORHOMES.

If NHTSA receives similar complaints, it may open an investigation, and if it finds that a safety defect exists in a group of vehicles, it may order a recall and remedy campaign. However, NHTSA cannot become involved in individual problems between you, your dealer, or Tiffin Motorhomes.

To contact NHTSA, you may either call the Vehicle Safety Hotline toll-free at 1-888-327-4236 (TTY: 1-800-424-9153); go to <http://www.safercar.gov>; or write to: Administrator, NHTSA, 1200 New Jersey Avenue, S.E., Washington, DC 20590. You can also obtain other information about motor vehicle safety from <http://www.safercar.gov>.

(ii) The manufacturer shall specify in the table of contents of the owner's manual the location of the statement in 575.6(a)(2)(i). The heading in the table of contents shall state "Reporting Safety Defects."

REPORTING SAFETY DEFECTS (CANADA)

Vehicles domiciled in Canada that are thought to have a defect that could cause a crash, injury, or death, should immediately be reported to Transport Canada and Tiffin Motorhomes at 1-256-356-8661.

GENERAL INFORMATION

If Transport Canada receives similar complaints, it may open an investigation; if it finds that a safety defect exists in a group of vehicles, it may order a recall and remedy campaign. However, Transport Canada cannot become involved in individual problems between you, your dealer, or Tiffin Motorhomes.

To contact Transport Canada, call the Defect Investigation and Recall Division toll-free in Canada at 1-800-333-0510 or 1-819-994-3328 in the Gatineau-Ottawa area or internationally.

By Mail:

Transport Canada – ASFAD

330 Sparks Street

Ottawa, ON

K1A0N5

SIGNALEMENT DES DEFAUTS DE SECURITE A TRANSPORT CANADA POUR LES PROPRIETAIRES CANADIENS

Si vous pensez que votre véhicule présente un défaut lié à la sécurité, vous devez immédiatement en informer Transports Canada (TC) ainsi que Tiffin Motorhomes, Inc.

Si Transports Canada reçoit des plaintes similaires, il pourrait ouvrir une enquête à ce sujet. Si le Ministère constate l'existence d'un défaut de sécurité au sein d'un groupe de véhicules, il pourrait ordonner une campagne de rappel et de réparation.

Toutefois, Transports Canada ne peut pas intervenir en cas des problèmes individuels entre vous, votre concessionnaire ou Tiffin Motorhomes, Inc.

Vous pouvez communiquer avec Transports Canada par l'un des moyens suivants:

Par téléphone: 819-994-3328 (région de Gatineau-Ottawa ou international)

Numéros sans frais: 1-800-333-0510 (au Canada)

Par la poste:

Transports Canada – ASFAD

330, rue Sparks

Ottawa (Ontario)

K1A 0N5

Vous pouvez également consulter le site Web de Transports Canada à tc.canada.ca pour remplir en ligne un formulaire de plainte de défauts.

GENERAL INFORMATION

TIFFIN MOTORHOMES LIMITED WARRANTY

The Tiffin Motorhomes limited warranty is provided to you by your authorized Tiffin Motorhomes dealer during the pre-delivery inspection. When you enquire about your Tiffin Motorhomes warranty, refer to this document. If you require an additional copy of the warranty or other information, contact:

Tiffin Motorhomes, Inc.

105 2nd St. NW • Red Bay, AL 35582

Phone: 256-356-8661

Email: info@tiffinmotorhomes.com

Visit www.tiffinmotorhomes.com for access to related materials.

MAJOR EQUIPMENT MANUFACTURERS

The following list is a compilation of the vendors and suppliers of the major subsystems and components of your motorhome. This list is provided for your convenience and is not a substitution of the literature accompanying the “how to contact us” information supplied by the vendors and suppliers in your Owner’s Information Package. Where appropriate, website information is also provided.

• Atwood Mobile Products	(800) 825 4328	atwoodmobile.com
• Aqua-Hot	(800) 685-4298	aquahot.com
• Denso Corporation	(800) 366 1123	globaldenso.com
• Flexsteel Industries	(563) 556 7734	service@flexsteel.com
• HWH Corporation	(800) 494-3213	hwhcorp.com
• Kwikkee	(541) 942-3888	kwikkee.com
• Norcold, Inc.	(800) 543-1219	norcold.com
• Onan Corporation	(256) 883-8164	onanindiana.com
• Power Gear	(800) 334-4712	powergear.com
• RV Products (Coleman A/C)	(316) 832-3400	airxcel.com
• Precision Circuits Inc.	(630) 240-9832	precisioncircuitsinc.com
• Saf-T-Alert (CO/LP Alarm)	(800) 383-0269	safetalert.com
• Sharp Corporation	(800) 237-4277	sharp-usa.com
• Suburban Manufacturing Co.	(423) 775-2131	suburbanmanufacturing.com
• The Dometic Corporation	(219) 294-2017	dometic.com
• Whirlpool	(800) 749 7929	whirlpool.com
• Winegard	(800) 288 8094	help@winegard.com
• LG	(800) 243-0000	lg.com
• Valid Manufacturing Ltd.	(888) 632-6477	validmanufacturing.com

WARRANTY SERVICE

All warranty service needs to be completed during the warranty period (basic warranty: 12 months or 12,000 miles). Tiffin Motorhomes warrants its unitized construction for 10 years and its laminations for

GENERAL INFORMATION

five years. Any service work performed after the expiration of the Tiffin Motorhomes warranties **WILL NOT** be covered by those warranties.

Exceptions may be made, on an individual basis, to this deadline, because of the unavailability of parts and/or service appointment time where work is to be performed. However, do not rely on the possibility of an exception; schedule any desired in-warranty work before your warranty expires.

OWNER'S INFORMATION PACKAGE

The Owner's Information Package includes valuable documents about your motorhome and its components and systems. By consulting the booklets and instruction manuals included in the Owner's Information Package, you will learn how to operate, maintain, and troubleshoot these items safely and effectively. The Tiffin Motorhomes Owner's Manual does not cover every possible detail of equipment—standard and/or optional—installed on or in your vehicle.

As with all valuable documentation, keep them in a safe, secure place for your later use and consultation. When you complete and mail to the respective manufacturers any warranty/guaranty registration cards, make a photocopy of both sides of each card before mailing, and keep the photo copy in your permanent records for your motorhome.

CUSTOMER RELATIONS

To schedule maintenance or service, or order parts, notify your local authorized Tiffin Motorhomes dealership to set up an appointment. If you are unsure of the location of your nearest authorized Tiffin Motorhomes dealership, access the Tiffin Motorhomes website at www.tiffinmotorhomes.com, and then click on the "Locate Dealer" button, and then enter the appropriate search criteria, such as state and retail sales, and then click on the red ball located on the map to find dealer information in that area.

SPECIFICATION LABELS

There are two main numbers used to identify your motorhome. The Vehicle Identification Number (VIN) is the legal identification of the vehicle. The VIN is the number used by the state for vehicle identification and registration. Additionally, there is a Tiffin serial number (Figure 1-2). This number can be found on the side of the dashboard. A typical sample this identification label is shown below.



Figure 1-2: Tiffin Serial Number



of

Figure 1-1: RVIA Label located on the outside of the motorhome

GENERAL INFORMATION



Figure 1-3: Federal Motor Vehicle Standards label located inside the doorway of the coach

Another label affixed to your motorhome is the Recreational Vehicle Industrial Association (RVIA) Weight Label (Figure 1-1), which is a required label for your vehicle. Tiffin Motorhomes, a manufacturer-member of RVIA, has the obligation to disclose the following information to the purchaser of the motorhome:

- An indication of the contents of the motorhome weight label affixed to the motorhome.
- A concise explanation of the following items' vehicle Weight (VW) distribution and proper weighing techniques to be used to weigh the vehicle.

Specific definitions for the following terminology:

Gross Vehicle-Weight Rating (GVWR) – This is the maximum permissible weight of the motorhome when it is fully loaded.

Unloaded Vehicle Weight (UVW) – This is the weight of the motorhome, as built at the factory, with full fuel, engine oil, and coolants. The UVW does not include cargo, fresh water, LP gas, or any dealer-installed accessories.

Occupant Cargo-Carrying Capacity (OCCC) – This is the GVWR of the motorhome minus UVW and weight of LP gas.

Gross Combination-Weight Rating (GCWR) – This is the value specified by the chassis manufacturer as the maximum allowable loaded weight of the motorhome with a towed trailer and/or vehicle (if any).

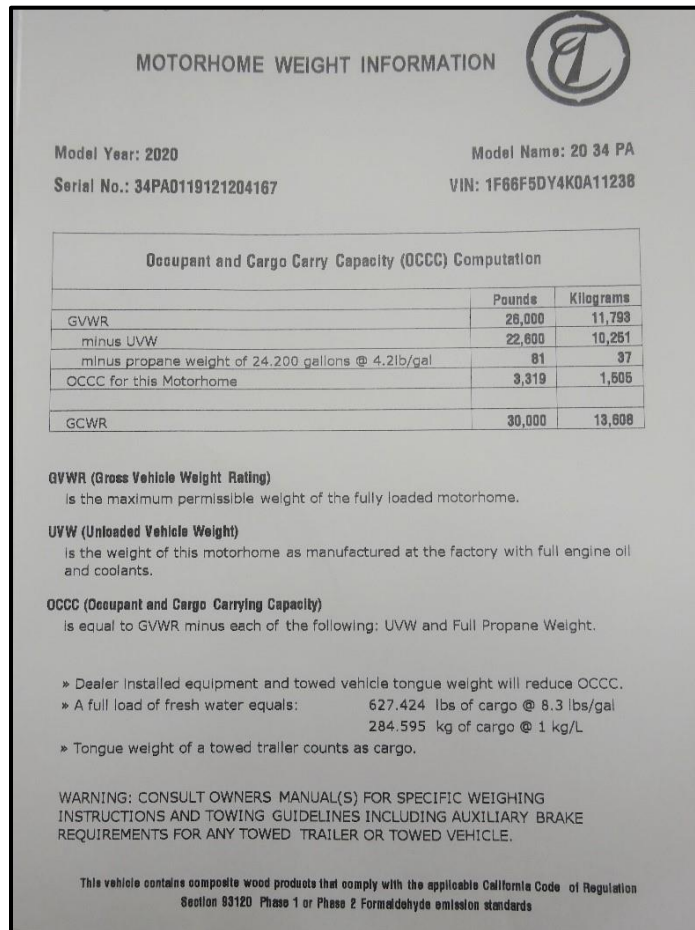

Figure 1-4: Sample Motorhome Weight Label (found in the bedroom closet)

GENERAL INFORMATION

Sleeping-Capacity Weight Rating (SCWR) – This is the maximum weight capacity of the combined number of persons (i.e., number of people multiplied by 154 pounds per person) permitted to sleep within the vehicle.

Gross Axle-Weight Rating (GAWR) – This is the maximum allowable weight for an axle; the GAWR considers the weakest link in the tire, wheel, brakes, hubs, axle, springs, and attaching parts. To illustrate, if the axle is rated at 15,000 pounds and the tires are rated at 3,200 pounds each as a dual installation, then the maximum GAWR will be 12,800 pounds for a four-tire vehicle.

WEIGHING PROCEDURES

To weigh the motorhome properly, the motorhome must be level when the weighing process is performed. Your motorhome has been designed and built in compliance with the recommended limits of the major-component/system suppliers to provide a realistic OCCC. It is up to the final user to provide even distribution to prevent uneven loading. Once the vehicle is loaded, it can be taken to any certified drive-on scales or individual-wheel scales to determine that the final weight is within specified limits for the motorhome.

To Determine the Final Weight of the Motorhome:

1. Drive the motorhome onto the scales so that all wheels are on the scales; this provides the gross vehicle weight (GVW) of the vehicle and can be recorded as such. The GVW must not exceed the GVWR specified for the vehicle.
2. Drive the motorhome so that only the rear wheels remain on the scales; this provides the total weight of the vehicle, save for the front axle. This weight must not exceed the total rating of the axles remaining on the scales. The front axle weight is determined by subtracting the weight from the GVW that was obtained in the first step. The result must not exceed the listed front-axle weight rating.

WEIGHT DISTRIBUTION

To ensure the maximum stability of the motorhome under static (i.e., parked) c (i.e., moving) conditions, the distribution of the items to be carried and stored within the motorhome and in the storage bays underneath the motorhome must be performed in such a manner as to strive for reasonably even side-to-side and front-to-rear dispersion of the weight of the stored items. This process will ensure that the motorhome is not “lop-sided” in weight distribution (i.e., all the stored weight is not on one side and/or mainly toward the front or the rear). Keeping a center of mass of the motorhome essentially centered on a front-to-rear and side-to-side basis will provide better control of the motorhome when it is in motion.

WAY FAREER

SAFETY INSTRUCTIONS

Chapter

2

SAFETY

SAFETY MESSAGES

Note that several labels listed in this manual represent items that need your attention. The Danger, Warning, Caution, and Notice labels alert you to precautions that might help you to avoid damage to your motorhome, its equipment, or your personal safety. Read and follow them carefully.

NOTICE

NOTICE is used to address practices not related to personal injury, or damage to the equipment.



CAUTION

CAUTION indicates a hazardous situation, which, if not avoided, could result in minor or moderate personal injury, or damage to the equipment.



WARNING

WARNING indicates a hazardous situation, which, if not avoided, could result in death or serious personal injury, or damage to the equipment.



DANGER

DANGER indicates a hazardous situation, which, if not avoided, will result in death or serious personal injury, and damage to the equipment.

SAFETY

SAFETY CONSIDERATIONS

Before using your motorhome, especially for the first time or after a long period of non-use, read all the instructions in the Owner's Manual and the chassis-manufacturer's manual thoroughly. There are several safety considerations that you must be aware of and follow while your motorhome is in motion. These safety considerations, as well as others meant to preclude any damage to the motorhome, are listed in this chapter. Besides the driver, it would be helpful for the passengers to be familiar with these safety considerations and precautions too.



WARNING

Before your motorhome is to be towed, be sure that you have read the entire Owner's Manual and that you fully understand the equipment on your motorhome and how to use that equipment safely.

GENERAL WARNINGS

In general, several "common-sense" safety precautions must be taken every time the motorhome is to be used on the road. These precautions include:

- Only seats with seat belts must be used while the motorhome is in motion; the seat belts should be worn by all people (driver and passengers) in the motorhome at that time.
- While the motorhome is moving, lock all seats in the forward-facing position to provide maximum safety for the users.
- While the motorhome is moving, no one (e.g., young children) inside should ever stand or kneel on the seats.
- In the majority of states, it is the law that seat belts must be used (fastened snugly about the chest and hip areas), anytime the motorhome is in motion, to provide desired protection in the event of a crash.
- Any fire extinguishers must be inspected on a monthly basis to ensure that each extinguisher is properly charged and ready for operation.
- Any smoke and/or carbon monoxide (CO)/liquid propane (LP) alarms must be regularly inspected and tested. If being used for the first time, the smoke and/or CO/LP alarm must be properly activated and fresh batteries installed before the motorhome is placed into service. Never sleep in a motorhome not having functional smoke and/or CO/LP alarms.
- While the motorhome is moving, the sleeping facilities are not to be used.
- Be sure to be familiar with all emergency exits (doors, emergency window). Do not use the emergency window as a routine exit; this is strictly to be used for emergency purposes only.

SAFETY

- Movement inside the motorhome should be minimized while the motorhome is in motion.
- Never leave the driver's seat unattended while the motorhome is in motion.

PRE-DEPARTURE CHECKLIST

For your continued safety and convenience, the following is a representative "checklist" designed to ensure your safety while driving:

- ✓ Clean all windows, mirrors, and light lenses (front, back, and sides) to ensure that you can "see" and "be seen."
- ✓ Reposition any mirrors or other fixtures to provide an unobstructed view (front, back, and sides) from the driver's seat.
- ✓ Remove or secure all loose fixtures (e.g., awnings, flags, antennas, portable lights) to keep them from falling from the motorhome when the vehicle is in motion.
- ✓ Make a "walk-around" visual inspection of the motorhome to note any irregularities (e.g., loose trim) or problems (e.g., low tires); correct noted problems accordingly.
- ✓ Check all exterior storage-compartment and generator-compartment doors to make sure that they are properly latched. If need be, check inside all exterior compartments to make sure that all cargo and equipment are properly secured so that they do not work loose and become hazards during sudden starts and stops.
- ✓ Check the tires for proper inflation (i.e., cold-inflation pressure: 100 psig). If the motorhome has not been used recently, make sure that the "cold-inflation" pressure is maintained. If the motorhome has recently been used, make sure that the "hot inflation" pressure (see the tire-manufacturer's literature to determine appropriate "hot inflation" pressure) is maintained. All tire pressures must be within 1-2 pounds (psi) of each other.
- ✓ Examine wheel lug nuts to ensure their proper tightness. If any lug nuts are found to be loose, first check the fit of the wheel to the hub to make sure the wheel is mounted properly, which would produce a "wobbly" wheel when the motorhome is in motion, and then tighten the lug nuts.
- ✓ Check all fluid levels (e.g., engine oil, transmission fluid, coolant, power-steering fluid, brake fluid, battery fluid [if applicable], windshield-washer solvent) to ensure that correct levels are maintained. Fill any low reservoirs, as needed.
- ✓ DO NOT SUBSTITUTE any other fluids for specified oils, transmission fluid, brake fluid, or other hydraulic fluids—substitutions are not acceptable and can void warranties.
- ✓ Before starting the motorhome engine, make sure all lines (e.g., water, sewer) and electrical power cords are disconnected and properly stowed.
- ✓ Ensure that the levelling jacks are in the "travel" position and antennas are securely docked.



SAFETY

- ✓ After entering the motorhome, make sure that the electrically actuated, retractable step has properly operated to retract the step fully before starting the engine of the motorhome.
- ✓ Check all interior doors (e.g., shower, microwave, refrigerator, etc.) to ensure that they are locked and/or secure. Make sure that all large items are stored away and secure (e.g., coffee pots, corning ware, etc.).

DRIVING SAFETY

Various adjustments must be made to ensure the driver's comfort and the safety of the motorhome before starting and moving the motorhome; these include:

- Do not attempt to adjust the driver's seat while the vehicle is moving.
- Do not adjust the tilt steering while the vehicle is moving.
- The driver must be familiar with all gauges, instruments, switches, and indicators on the instrument panel before driving.
- Do not operate the cruise-control function during any extreme weather situations (e.g., snow, ice, sleet, heavy rain), or when road conditions are hazardous (icy, snowy, winding roads, city traffic), when a constant speed of the motorhome is not possible, or if traffic conditions do not warrant such.
- Avoid driving the motorhome through any standing water. If deep enough, such water can wet the brake pads and cause fading of the brakes (i.e., loss of braking power) and lead to excessive sliding or pulling to one side or the other.
- Know the limits of operation of the motorhome. Do not try to achieve excessive speeds, climb overly steep hills, traverse overly long grades, attempt to use as an "off-the-road" (OTR), rapidly switch lanes, or rapidly accelerate or decelerate the motorhome. When in doubt about the handling characteristics of the motorhome, consult your chassis manual for information.
- The solar or blackout shade is operated by using a switch on the driver's console. Depress the switch to lower or raise the shade. On the Wayfarer, the switch is labeled SOLAR SHADE or NIGHT SHADE. The time delay switch must be held for a few seconds before it is activated.



Figure 2-1: Driver's side Dashboard and Instrument Console



- **NEVER** drive the vehicle with a slide-out room extended.

SAFETY

FUELS FOR THE MOTORHOME



WARNING

Liquid propane (LP) gas containers, gasoline, or other flammable liquids must not be placed or stored inside the motorhome because a fire or explosion might occur. LP gas containers (Figure 2-2) are equipped with safety valves that might relieve excess pressure by discharging gas into the atmosphere—any containment of that vented LP gas constitutes an explosive hazard.



Figure 2-2: LP Tank

Your motorhome is designed to use low sulfur fuel only for the engine used in the routine operation of the motorhome—these require prudent and safe handling to ensure safety of the motorhome and its occupants; namely:

- Anytime the motor fuel is to be filled, turn OFF the motorhome engine, all pilot lights, and appliances.
- DO NOT SMOKE when refilling the fuel tank.
- NEVER use an open flame to test for LP gas leaks or to examine the fluid levels in the fuel tanks.
- After filling any LP system, immediately replace and secure all protective covers and caps.
- After closing the LP valve, close and securely latch the LP door to prevent unintentional access or damage.
- NEVER connect natural gas to the LP gas system—LP gas and natural gas are not interchangeable.
- When lighting range burners, do not turn burner controls ON and allow the gas to escape before lighting.
- NEVER use any other “burning” equipment (e.g., charcoal grills, wood stoves, butane lights, propane lights) inside the motorhome. Doing so might cause fires and/or asphyxiation.



DANGER

All pilot lights, appliances, and their ignitors must be turned OFF before refuelling of motor fuel tanks or propane containers. A failure to comply could result in serious injury or death.

SAFETY

	WARNING
Any portable, fuel-burning equipment (e.g., charcoal, propane, butane, wood) must not be used inside the motorhome. Any use of such equipment inside the motorhome might readily cause fires and/or asphyxiation by carbon-monoxide poisoning. Moreover, such unauthorized use will probably invalidate your motorhome insurance policy.	

LIQUID PROPANE (LP) GAS SYSTEM

Check the propane gas system for leaks yearly or as necessary. If you smell propane within the motorhome, quickly perform the following:

- Extinguish any open flames, pilot lights, and all smoking materials.
- Do not touch electrical switches.
- Shut off the gas supply at the tank valve or gas supply connection.
- Open doors, windows, and other ventilating openings.
- Leave the area until the odor clears.
- Have the propane system checked and leakage source corrected immediately.

	WARNING
A failure to comply with the above guidance could result in serious injury or death.	

A WARNING label is located near the LP Any overfilling of the result in uncontrolled condition for a fire or The LP container filled to only 80

	WARNING
DO NOT FILL the LP container to more than 80 percent of capacity.	

such as the following gas container. LP gas containers can gas flow – a prime explosion. (Figure 2-3) must be percent of its capacity;

SAFETY

the remainder of the cylinder space is an air space to contain expansion of the liquid when subjected to varying ambient-temperature conditions.

Filling in excess of 80 percent of the liquid volume of the container reduces the air space and, thus, creates a condition for possible over-pressurization of the container.

All LP appliances in your motorhome have been approved for use in motorhomes by a nationally recognized testing laboratory (i.e., UL and CSA certified). When properly used, LP gas is a clean-burning fuel, which can be dependably used. In actuality, the LP container contains liquid propane under high pressure.



Figure 2-3: LP Tank

The liquid, when it passes through the tank valve to a lower pressure, vaporizes into a gas, and then passes through a regulator to maintain a constant pressure. This gas, then, is the actual fuel distributed through the LP-gas manifold system to the LP-based appliances used in your motorhome.

LP-appliance lighting problems are typically caused by an improperly adjusted gas regulator. NEVER attempt to adjust or reset the gas regulator yourself. An authorized service technician is needed to make these adjustments. As a good preventive-maintenance activity, the regulator should be checked annually by a service technician and before every extended trip.

Even though the LP-gas system is leak-checked and verified at the factory at the time of manufacture, normal usage (travel vibrations, etc.) could loosen the fittings. Consequently, it is wise to check the gas fittings periodically for leak tightness.

You can wipe some leak-detector solution (e.g., a “liquid-soap”-like solution) on all the fittings, connections, and junctures when the system is under pressure. Should there be any leaks, small bubbles will appear at any leak sites.

Generally, loose fittings can be tightened to stop the leaks. If this process does not work, then you must shut off the main gas valve at the LP cylinders and immediately consult an authorized service technician to determine what repairs are necessary. Leaks may also be detected by noting a sulphurous odor (i.e., rotten eggs). DO NOT search for a leak by using a match or open flame.

SAFETY



WARNING

When the motorhome is not in use, be sure to close the main LP gas valve at the tank. When the LP gas tank is to be refilled, close the main valve to preclude the chance of pilot lights possibly igniting fumes from the LP fuel. As some LP-gas appliances (e.g., refrigerator, furnace, water heater) have Direct Spark Ignition (DSI) systems, it is very important that these appliances be turned off when the LP gas is off. The DSI boards will continue to work (i.e., emit an ignition spark) even when there is no LP gas available.

LP GAS REGULATOR

The LP gas regulator (Figure 2-4) is the most critical element of the LP-gas distribution system. The regulator converts the high-pressure LP gas from the tank into a reduced-pressure LP-gas supply suitable for use in the various appliances in the motorhome.

You must regularly inspect the regulator system. If any damage or corrosion is noted, contact an authorized service technician to inspect and repair or replace the regulator.

Do not attempt to adjust the regulator yourself; the regulator has been pre-set at the factory. Only a qualified LP service technician using specialized equipment should adjust the regulator.



Figure 2-4: LP Gas Regulator

LP DISTRIBUTION SYSTEM

The primary LP distribution system in the motorhome is a steel manifold located underneath the motorhome. The secondary distribution lines running from this main distribution system are usually reinforced rubber supply lines.

If any of the gas lines break, do not attempt to splice them—always run new lines to maintain the safety of the motorhome. Tiffin Motorhomes recommends that only qualified service technicians perform this work.

Remember, the main valve at the LP gas tank must be closed whenever any gas appliance is to be installed, removed, or serviced—this process prevents LP gas leakage, which could result in a possible harmful explosion. If the odor of LP gas is ever detected, immediately discontinue use of any gas appliances and seek the services of a qualified service technician.

SAFETY

	WARNING
The LP gas distribution system in your motorhome is designed for liquefied petroleum (LP) gas ONLY. DO NOT attempt to connect and use any natural gas or butane gas system with this LP gas system.	

RECOMMENDED PRACTICES

The following practices are recommended to ensure continued safety and reliability of the LP gas system. These are representative, and not exhaustive. In all cases, use common sense in the use of the LP system:

- Visually inspect the LP fill valve before any refueling operation for foreign materials or debris; remove, as necessary, to ensure a leak-tight connection.
- Before any refueling operation of the LP gas system, shut off all the pilot lights.
- NEVER, under any circumstances, check for LP gas leaks with any type of open flame; doing so would probably cause an explosion and subsequent fire.
- Annually and before any major trips, visually inspect the entire LP gas distribution system.

Should problems be noted, seek the services of a qualified service technician to make necessary repairs and perform any maintenance.

CARBON MONOXIDE WARNING

	WARNING
Avoid inhaling exhaust gases as they contain carbon monoxide, which is a colorless, odorless, and poisonous gas. Serious illness, injury, or death can result.	

A properly maintained engine exhaust and ventilation system is the best way to protect against carbon monoxide's entry into the vehicle. Tiffin Motorhomes recommends that the exhaust system and body be inspected by a qualified motorhome service center:

- Each time the vehicle is serviced for an oil change.

SAFETY

- Whenever a change in the sound of the exhaust system is noticed.
- Whenever the exhaust system, underbody, or rear of the vehicle is damaged.

To allow proper operation of the vehicle's ventilation system, keep the front ventilation inlet grill clear of obstructions at all times.

Do not occupy a parked vehicle with the engine running for an extended time, and do not run the engine in confined areas, such as a garage.

Your motorhome is equipped with a combination CO/Gas Alarm (Figure 2-5). This alarm combines a single compact system that detects both Carbon Monoxide (CO) and Propane (LPG) gas. It will detect carbon monoxide gas from any combustion source such as the furnace, oven/range, water heater, refrigerator, chassis engine, and generator engine.

CO/LP GAS DETECTOR

Since LP gas is denser than air, the LP gas will naturally settle to the lowest point in an enclosed space. In the motorhome, this would be the floor. Because of this, the CO/LP gas detector (Figure 2-5) is necessarily mounted close to the floor.

To activate the CO/LP-gas sensor on this detector for the first time, remove the sensor activation strip, if it was not removed during the pre-delivery inspection.

If the alarm persists in re-arming and giving further alarms, ventilate the motorhome by opening the doors and windows. After the ventilation process is concluded, shut all the doors and windows, and then take the motorhome to a qualified service technician.

The CO/LP gas detector is a single compact system that provides a powerful combined alarm that detects both Carbon Monoxide (CO) and explosive gases, such as Propane (LPG) and Methane (Natural Gas). This detector uses the latest microprocessor technology combined with two electronic self-cleaning sensors that operate independently of each other. The combined unit can detect both CO and explosive gases simultaneously.

Carbon monoxide (CO) is a colorless, odorless, tasteless gas, which, when breathed, bonds to the hemoglobin in the red blood cells and, thus, drastically reduces or blocks the transfer of oxygen from the lungs to the rest of the body.

In sufficient concentrations, CO kills by asphyxiation. In lesser amounts, CO makes the victim groggy, lethargic, and unable to think clearly or quickly.

CO is one of the products of combustion for many materials including petroleum-based products (e.g., gasoline, diesel fuel, propane, butane, etc.). Since many of the appliances and the engines associated with the motorhome produce CO in their normal operations, it is necessary to ensure that CO levels do not rise to dangerous levels within the motorhome. In sufficiently high concentrations, CO can kill in minutes.



Figure 2-5: Carbon Monoxide/LP Gas Detector

SAFETY

The most susceptible people to CO poisoning are unborn babies, small children, pregnant women, senior citizens, and people with cardiovascular or respiratory problems.

Consequently, it is prudent to check the CO monitor regularly for normal operation and to remain aware of the symptoms of CO poisoning, which include dizziness, nausea, vomiting, muscular twitching, throbbing in the temples, incoherent thinking and speech, weakness, sleepiness, and intense headaches.

If any of these symptoms are experienced in the motorhome, IMMEDIATELY evacuate the motorhome and seek medical help. Shut down the motorhome and do not attempt to operate it again until the sources of the CO are located and fixed.



DANGER

Carbon monoxide gas—derived from products of combustion of diesel fuel, LP gas, and other petroleum-based products—is a deadly gas that can kill motorhome occupants, if allowed to accumulate in sufficient concentration. Ensure that no engine operations are restricted—tailpipes and exhaust ports should not be blocked or restricted in any way. Additionally, any accumulation of exhaust gases outside or underneath the vehicle must be avoided as it might enter the motorhome through windows or vents—be careful of how and where the motorhome is parked to avoid such conditions. Regularly monitor outside conditions to ensure that all exhaust gases can readily be dissipated and not enter the motorhome inadvertently.



DANGER

Never sleep in a motorhome when the engine is running—engine exhaust fumes could enter the motorhome and cause disability or death. Regularly check the exhaust system to note any leakage sites and, if found, discontinue use of the motorhome until they are repaired by a competent, qualified service technician. Do not attempt repairs on the exhaust system yourself and do not modify (temporarily or permanently) the exhaust system at all.

SAFETY

FIRE SAFETY

As with any enclosed system containing the three required conditions for fire (i.e., combustible materials, oxygen, and ignition sources), there will exist the possibility of fire inside the motorhome. Tiffin Motorhomes has taken every precaution and design practice to minimize or negate this possibility, but the final determination rests with the owner and user of the motorhome. Hence, the owners, users, and their guests must be aware of basic fire-safety practices and procedures, and those particular features that Tiffin Motorhomes has provided for fire safety.

FIRE EXTINGUISHER

The motorhome is equipped with a fire extinguisher located in the entrance door stairwell (Figure 2-6). The extinguisher is rated for both Class B (i.e., grease, gasoline, diesel fuel, flammable liquids) and Class C (i.e., electrical) services.

Read and understand the accompanying owner's manual on the extinguisher (found in your Owner's Information Package) and remember the location of the extinguisher. These types of fire extinguishers are pressurized mechanical devices and require that appropriate care be used in their safe storage and use. The owner's manual will provide necessary guidance for the proper storage, handling, and use of the extinguishers.

Prudent preventive maintenance suggests monthly inspection of any fire extinguisher to ensure that it is sufficiently pressurized (i.e., the needle on the gauge is in the "normal" zone) and that the mechanical components are not blocked in any way.

DO NOT test a fire extinguisher by partially discharging the unit—this will cause a loss of pressure and might lodge some fire-retardant materials in the valve mechanism and cause the extinguisher to continue to vent slowly down to zero pressure. If an extinguisher is ever partially used, continue its use until the unit is completely discharged. Then, have the fire extinguisher fully recharged at an appropriate service center (call any fire department for information on having an extinguisher recharged in that particular locality).

DO NOT wait to recharge an empty fire extinguisher; you will never know when it might be needed.

Should a fire occur inside or around the motorhome, evacuate the motorhome quickly and calmly—do not panic. In the event of heavy smoke or extensive flames, keep low (crawl if you must), and make your way to the nearest exit (door, emergency window) and leave. If the fire involves a fuel source (e.g., diesel fuel, LP gas), consider the probability of an explosion and move sufficiently far away to minimize personal harm. If possible, immediately place a call to the local fire department (or ask someone nearby to do so) to report the fire. Consider the cause and the consequences of the fire and the risks associated with possibly fighting the fire yourself before trying to extinguish it.

DO NOT expose yourself or others to unnecessary danger.



Figure 2-6:
Fire Extinguisher

SAFETY

SMOKE DETECTOR

The motorhome is equipped with a battery-operated smoke detector (Figure 2-7) located on the ceiling in the living area of the motorhome.

The smoke detector must be tested on a weekly basis, before each trip, and after any period of storage of the motorhome.

If a low-battery condition is noted or the alarm “chirps” to indicate a low-battery condition, immediately replace the battery. Tiffin Motorhomes recommends that you keep replacement batteries in the motorhome for any in-transit replacements so that the smoke-alarm capability is never compromised.



Figure 2-7: Smoke Detector

DO NOT disable the smoke detector for any transient, false alarm (e.g., cooking smoke, dusty furnace, tobacco smoke). Ventilate the motorhome with fresh air and the alarm will reset on its own.

ELECTRICAL

- Careless handling of electrical components can be fatal. Never touch or use electrical components or appliances while feet are bare, while hands are wet, or while standing in water.
- Improper grounding of the vehicle can cause personal injury.
- Do not attach an extension cord to the utility power cord.
- Do not use any electrical device that has had the ground pin removed.
- Avoid overloading electrical circuits. Replace fuses or circuit breakers with those of the same size and amperage rating only. NEVER use a higher rated fuse or breaker.

LOADING

- Store or secure all loose items inside the motorhome before traveling. Possible overlooked items such as canned goods or small appliances on the countertop, cooking pans on the range, or free-standing furniture can become dangerous projectiles during a sudden stop.
- Be aware of GVWR, GAWR, and individual load limit on each tire or set of duals.
- Never load the motorhome in excess of the gross vehicle weight rating or the gross axle weight rating for either axle.

MAINTENANCE

- Do not remove the radiator cap while the engine and radiator are still hot. Always check the coolant level visually using the see-through coolant reservoir.
- NEVER get beneath a vehicle that is held up by a jack only.
- Do not mix different construction types of tires on the vehicle. Replace tires with the exact size, type, and load range.

SAFETY

EMERGENCY EXITS

The living areas of the motorhome are equipped with emergency exit windows (Figure 2-8 and Figure 2-9). These windows are designed for emergency exits when it is not practical to exit by the door, which also is an emergency exit—in the front of the motorhome. These windows are readily noticeable by their red handles and the red EXIT label on the windows.



Figure 2-8: Emergency Window



Figure 2-9: Emergency Exit Latch

To use these windows as emergency exits, lift the handle and push outward on the window. As required, the window can be closed by pulling the window inward and then lowering the handle to latch the window back in place. When the motorhome is to be parked, note where these windows will be, so that the exits will not be blocked (e.g., against a tree, pole, or wall).

PARKING PROCEDURES

To park the motorhome in any unfamiliar terrain, examine the site for surface irregularities, slopes, or inclines, and other items such as stumps, rocks, or external connections for power/water/sewage, and examine the area immediately above the parking site for obstructions like tree branches and limbs, signs, and overhead wiring.

If the motorhome is to be backed into the parking site, try to have that site on the driver's left-hand side, as this will allow the driver to watch the rear of the motorhome. Back up slowly and use the side mirrors and the back-up camera as a guide or, better yet, have another person outside provide guidance to help park the motorhome.

When the motorhome is finally situated, shift the transmission into park, set the foot-operated park brake, and then turn OFF the engine. Activate the air levelling system to level and stabilize the motorhome.

If the motorhome is to be powered externally, connect the 120 VAC power to the motorhome. If the motorhome uses LP gas, turn ON the LP gas valve at the LP tank. Connect the fresh-water supply and sanitize the water systems (see Chapter 14) as needed. Connect the waste drain hose to the external sewer hook-up. Start the refrigerator, water heater, and furnace, as warranted. Light the oven pilot light,

SAFETY

as needed. Certain appliances, such as the refrigerator, will not work properly, if the motorhome is not level, so be sure to complete the motorhome-leveling process before activating any of the appliances.

TOWING HITCH

The motorhome is fully capable of towing typical motor vehicles.

The Wayfarer is equipped with a 2,000 pound towing hitch (Figure 2-10), and associated wiring connector.

The towing hitch features a standard 7 pin wiring connector. If desired, a trailer brake actuator can be added. The plug for the actuator is located to the left of the steering column, underneath the dash.

The motorhome is capable of towing light loads, and instructions are found in the chassis manufacturer's literature in the Owner's Information Package provided with the motorhome.

The total weight of the motorhome and any vehicle towed by that motorhome must not exceed the Gross Combined Weight Rating (GCWR).



Figure 2-10: Towing Hitch

NOTICE

When the motorhome is being weighed, account for passengers and their locations in the motorhome.

The tongue weight must not exceed 10 percent of the towing capacity. Information related to the motorhome weight and GCWR can be found on a sticker inside the motorhome closet. Any vehicles to be towed by the motorhome must have adequate active braking.

Tiffin Motorhomes does not recommend using any type of hydraulic towing lift that attaches to the rear of the motorhome designed to carry motorcycles, scooters, golf carts, etc.

WAY FAREER

HEATING & AIR CONDITIONING

Chapter

3

HEATING & AIR CONDITIONING

FURNACE

The Wayfarer is equipped with a forced-air furnace fuel by LP gas. The furnace is controlled by the wall-mounted thermostats (Figure 3-1) located inside the motorhome. These thermostats control both the heating and air conditioning for the motorhome.

In the gas-heating mode, the furnace heats air which, in turn, is circulated through ductwork in the floor of the motorhome. If any obstruction(s) block the floor vent(s) or air-return register, then the furnace will not function properly. Any items stored under the cabinets should be carefully stowed to prevent damaging or crushing the furnace ducting or blocking the warm-air return.

When a furnace is being used for the first time, there may be an initial off" of manufacturing compounds or residues left on the heat the ductwork which could produce odors, fumes, and possibly some smoke. This is normal and should not cause concern, unless it persists for an excessive amount of time.

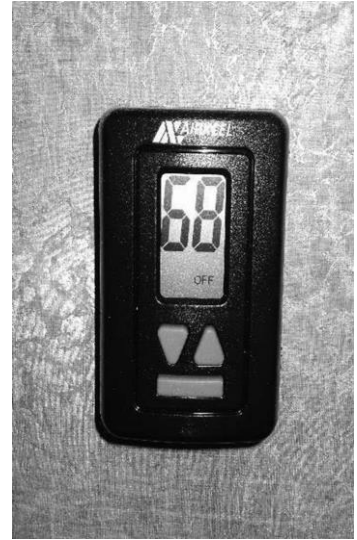

Figure 3-1: Thermostat

NOTICE

NEVER attempt to modify the furnace. To do so may cause fire, explosion, carbon monoxide poisoning or asphyxiation. If the furnace is malfunctioning, immediately shut the unit "off" and call a trained service technician as soon as possible.

To minimize the after-effects of this "burn-off" process, the initial use of the furnace should be done with all the doors and windows open to permit normal air circulation to dissipate these odors and fumes.

For routine operation of the furnace, set the thermostat to the desired temperature setting and then turn the thermostat to gas heat. In about a minute, the furnace should begin to operate and warm or hot air should be coming through the ductwork.

To shut down the furnace, turn the thermostat to the "off" position. Even though the thermostat may be turned "off," the furnace system will continue to run for about a minute or so to permit a gradual cool-down of the heating system which is normal.

On a regular basis, thoroughly clean the complete furnace and air-tube passageways to remove dust, lint, and any other possible obstructions. Leak-test the entire LP gas system at least annually. Also check and clean the air-blower system annually.

Any access hatches to the furnace are for authorized service personnel only, as there are no user serviceable parts on the furnace. Accordingly, do not attempt to tamper with the interior of the furnace.

HEATING & AIR CONDITIONING

NOTICE

Be cautious when washing the exterior of the motorhome. Water should never be sprayed directly into the furnace vent. Should any water be forced beyond the rain baffles into the furnace vent, the furnace may rust which, in turn, may cause improper combustion and produce unwanted by-products of combustion.

Before the beginning of each travel season, the

furnace should be thoroughly cleaned and inspected. Any obstructions, debris, or lint which may obstruct free air flow or impede the operation of the air circulation system should be removed. For example, accumulated dust or lint could possibly obstruct the orifices for the pilot light or may accumulate on the blower blades and unbalance the operation of the blower. Additionally, any debris in the ductwork, when heated by the furnace, could emit unpleasant odors or possibly become a fire hazard.

The furnace system should be periodically cleaned. Annually is recommended unless the motorhome is subjected to dust levels significantly greater than average, in which case more frequent cleaning is recommended. The Owner's Information Package provides recommended cleaning tips and procedures. When needed, a more thorough cleaning should be performed by a qualified service technician.

AIR CONDITIONING SYSTEM

The factory-installed air-conditioning system is designed for 120 VAC power supplied either from the external power cord or from the generator. For the best cooling scenarios, park the motorhome in a shady location whenever possible and close drapes on those windows exposed to direct sunlight.

The air-conditioned, cooled air is emitted through "chill grill" vents, which are located in the center of the coach. The return air vents have a filter that prevents dust from flowing back through the air conditioning system. The return filters can be easily removed and cleaned with warm water and a mild cleaning solution. To remove the filter, simply pull the vent down and lift the filter from inside the opening.

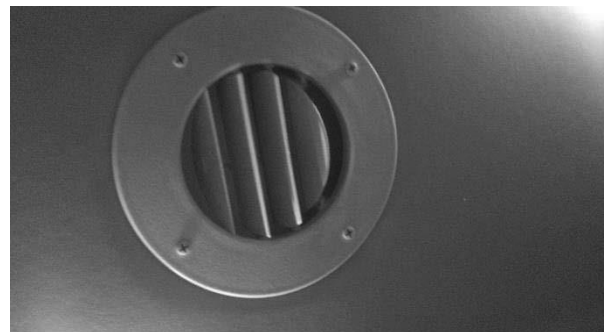

Figure 3-2: Round Air Vent

HEATING & AIR CONDITIONING

THERMOSTAT CONTROLS

- Press the Up and/or the Down buttons to set the desired temperature for the motorhome.

For more detailed instructions, please consult the thermostat literature in the Owner's Information Package.



Figure 3-3: Thermostat

NOTICE

The air conditioning system is the major consumption device of electrical power in the motorhome. When this system is being used in an RV park, cumulative use of these air-conditioning systems by the resident vehicles can create a bigger demand for electrical power than is actually available. Accordingly, at times a "brown-out" condition may arise. This is when the AC voltage normally available drops to a lesser value (e.g., 10-20% below normal or more).

"Brown-out" conditions cause appliances to draw greater currents to make up for the reduced voltage; thereby causing circuit breakers to trip or fuses to blow. Under such conditions, your own motorhome is not at fault; simply reset your breakers and/or replace your fuses. Should such conditions continue, you may wish to reduce the electrical load (in this case, turn "off" the air conditioning system for awhile) or start the electrical generator.

HEAT PUMP CONTROLS

To activate the heat optional pump, set the thermostat to ELEC HEAT and select desired temperature.

NOTE: If the setting on the thermostat and the room temperature are more than five degrees apart, the gas furnace will automatically turn ON with the heat pump. Once the room temperature reaches the desired level specified on the thermostat setting, the furnace will cut off and the heat pump will maintain the heating of the coach.

NOTE: The heat pump is controlled by the thermostat located in the bedroom area of the motorhome.

If the external temperature falls to 35-38 degrees Fahrenheit, the heat pump will become inoperative and the gas furnace will begin to operate automatically.

HEATING & AIR CONDITIONING

HOW THE HEAT PUMP THERMOSTAT WORKS.

The RvComfort.HP, the RvComfort.PHP, the Coleman True-air, and the RvComfort.ZC thermostats by RvProducts Inc. are all capable of running not only an Air Conditioning unit, but also an Electric Heat Pump. Frequently we receive calls from customers who do not understand the functions of the Heat Pump Thermostat. This guide is a quick run through of the information already provided in the Thermostat Operation Manual, included with each thermostat.

The Heat Pump is an electric source of heat. IT will supply and maintain heat assuming the outside (ambient) temperature is above 40 degrees. This number of course can be slightly higher or lower depending on the humidity. Higher humidity can cause a heat pump to lose efficiency at higher ambient temperature, while lower humidity can cause a heat pump to lose efficiency at a lower ambient temperature.

Since no one wants to wake up to find that the outside temperature has dropped below 40 degrees and it is now 50 degrees in the coach, the Heat Pump thermostats are programmed internally to recognize when the temperature drops five degrees or more from the set temperature to the actual inside room temperature. When the temperature exceeds five degrees or more between the two, the thermostat will default to the next available heat source.

The thermostat, upon sensing a temperature split of five degrees or more in the electric heat mode will bring the gas heat on to assist the electric heat. This is the first strike. A strike is created by the thermostat having to change modes (or run dual modes to sustain a temperature split). The electric heat and gas heat will continue to run together until the thermostat reaches the set temperature and satisfies. When the electric heat comes back on. It will be in electric heat only at that point. If the temperature again drops five degrees or more from the set point, the thermostat will again bring on the gas heat to assist. This is strike two. The system will then go through the above stated procedures. If the temperature should drop five more degrees from the set point or a third time, the thermostat will give up the electric heat, lock the electric heat out for two hours (showing either DIFF on the display or FLASHING GAS HEAT on the display) and default to GAS heat only. You WILL NOT be able to run any Electric Heat during this two-hour lockout.

WAY FAREER

LP GAS SYSTEM

Chapter

4

LIQUID PROPANE (LP) TANK

The Wayfarer is equipped with an ASME (American Society of Mechanical Engineers) approved LP tank (Figure 4-1) which is equipped with an automatic pressure regulator. This tank contains liquid petroleum fuel under high pressure.

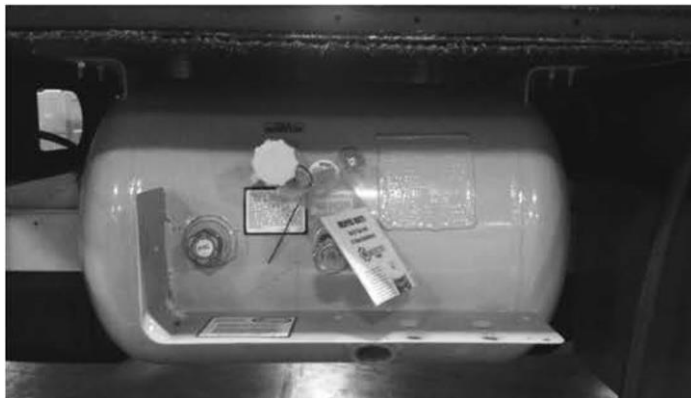

A LP gas-distribution system distributes the gas to those appliances using such in the motorhome. The “heart” of this LP gas distribution system is the regulator and it should only be adjusted by a qualified service technician. Most of the problems encountered in lighting the pilots of these appliances are caused by regulator mis-adjustments.

The major component of the LP gas supply is a pipe which runs underneath the motorhome floor. The various gas appliances are connected by a rubber supply line.

Should any of the secondary tubing develop a leak, do not attempt to splice any of the lines. Instead, have a qualified service technician run a new length of tubing to the appliance of concern and then have that line leak-tested before placing it in normal operation.

To remove, repair, or replace any gas-operated appliance, always close the main gas valve at the LP tank.



WARNING

When the motorhome is not being used, the main LP gas valve must be turned “off.” Also, turn “off” the main valve when the LP gas tank is to be refueled to avoid the possibility of ignition fuel fumes by the pilot lights. All gas valves on the gas-operated appliances with Direct Spark Ignition (DSI) should also be in the “off” position during refueling and/or maintenance operations. DO NOT store LP, diesel fuel, propane, butane, or other flammable liquids inside the vehicle as these represent a very real fire hazard and possible threat to life.

NOTICE

If a gas leak is noted or suspected, turn “off” the main valve and keep the LP gas system “off” until that system is inspected by a qualified service technician as soon as possible. Do not delay in addressing any possible gas leaks with appropriate service because of the inherent hazards to safety.

LP TANK FILLING PRACTICES

Any LP gas tank associated with the motorhome should never be filled to more than 80 percent of total capacity. Filling should always be done only when the motorhome is leveled. If the motorhome is not level, the tank may be overfilled (i.e., more than 80 percent of capacity) and, thus, subject the motorhome to possible fire or explosion from resultant uncontrolled gas flows.

LP GAS REGULATOR

As noted earlier, the LP gas regulator (Figure 4-2) is the “heart” of the LP gas distribution system. This regulator reduces and controls the pressure of the gas on the outlet end to provide a constant supply of gas at a constant pressure to the gas-operated appliances. The regulator has a vent to relieve excess pressure on the inlet side of the regulator, should excess pressure develop in the gas tank and connecting gas line to that regulator inlet. The vent would normally release the excess LP gas to the atmosphere until the over-pressurization condition is eliminated.

This vent should be regularly checked to assure that it is not clogged or obstructed. If that vent is blocked from normal operation, component or system failures may result. If periodic visual inspection indicates any sign of corrosion or degradation, contact a qualified service technician to repair the regulator as soon as possible; DO NOT operate the LP gas system with any faulty component in place.



Figure 4-2: LP Gas Regulator

NOTICE

When a LP gas regulator is installed or re-installed, the regulator must always be installed with the gas diaphragm vent facing downwards. For more information, consult the manufacturer's literature in your Owner's Information Package that came with the motorhome.

Always keep the main valve to the LP gas tank closed when the system is not in use. When the LP tank is empty, keep the main valve closed until re-filling is to be performed—this process will keep any moisture-laden air from back-flowing into the gas system and trapping unwanted moisture in the LP gas tank. If an empty LP gas tank has been exposed to the atmosphere for an extended time, let a qualified service technician purge the tank before its next filling operation.



When assembling your LP quick connect line, rotate the shut off lever shown in the picture below. Next, pull back on the release (Circled). Insert quick connect line. After inserting, rotate shut off lever back in to lock position.

*When LP quick connect is not in use, to ensure you don't have any leaks have the valve in the position shown in the picture below.

WAYFARER

MAJOR APPLIANCES

Chapter

5

LP/GAS REFRIGERATOR

Your coach may be equipped with a standard LP/gas refrigerator. When this refrigerator is in the “LP gas” mode, make sure that the main LP gas valve is in the “on” position before attempting to start the refrigerator. Please note that the refrigerator is equipped with a semi-automatic energy selector (AES) control system which can be set automatically to switch between a 120volt AC system or a LP-gas operation system when available.

A 12-volt power supply (e.g., 12 VDC system of the motorhome, auxiliary battery, converter, or motorhome engine battery) is required for proper operation of the electronic control panel. For 120 VAC electrical operation of the refrigerator, either the 30 AMP shore power line must be connected or the on board generator must be running, or the refrigerator is also connected into the inverter system to provide the necessary 120-volt AC power.



Note: Running the refrigerator on inverter power for prolong periods of time will drain the motorhome batteries.

To operate the refrigerator in the LP-gas mode, the main LP gas valve must be “open.”

For specific instructions on refrigerator, please refer to the operating booklet found in the Owner’s Information Package.

MICROWAVE OVEN



NOTICE

The majority of LP gas appliances used in motorhomes normally vent to the outside of the motorhome. When your motorhome may be parked in close proximity to a fuel pump (i.e., during re-fueling operations), it is possible that the diesel fumes could enter this type of appliance and possibly be ignited by the burner flame thereby causing a fire or explosion. Accordingly, please use extreme caution when re-fueling the motorhome.

The Wayfarer contains a convection microwave. All microwave ranges operate on 120-volt AC electrical power, supplied either by the external electrical hookup or by the onboard electrical generator in the motorhome. Touch pad controls are used for operating the convection microwave (i.e. cooking temperature, mode, power level, and cooking time). For basic operating instructions, care, and maintenance for the proper use of the microwave, please consult the specific manual in the Owner's Information Package.

COOK TOP

The Wayfarer is equipped with a standard recessed two-burner range (Figure 5-4).

Do not attempt to adjust the oven pilot light as it has been factory-adjusted and factory-set. To extinguish the oven pilot light when use of the oven is concluded, push inwards on the oven control knob and turn that knob clockwise (CW) to the “off” position.

To operate either the two-burner range or the optional two-burner, recessed cook top, light the burners by turning “on” the gas control knob, wait a couple of seconds, then push the red DSI (direct spark ignition) button until a flame appears.

If the burner does not start after a few attempts, discontinue the process, let the released gas dissipate, then try the process again. The burner knobs operate in a CCW manner and must be gently pushed inwards as they are being turned. Never use the cook top when the motorhome is in motion.

It is wise to have a qualified service technician periodically check the entire LP-gas distribution system in the motorhome. Scheduling such an inspection annually would be a recommended, preventive maintenance routine for each motorhome owner.



WARNING

DO NOT USE cooking appliances as a heating source for the motorhome. Cooking appliances require fresh air for safe operation. Before using any cooking appliances, make sure that overhead vent or window is open and/or turn “on” an exhaust fan.



WARNING

WARNING Portable fuel burning equipment, including wood and charcoal grills and stoves, should **NEVER** be used inside the motorhome. The use of this equipment inside the coach can cause fire or asphyxiation and could result in serious injury or death.



DANGER

All LP gas-operated appliances in the motorhome will consume oxygen. If the motorhome is totally closed during such operation, the oxygen level may be reduced and the associated carbon monoxide level may be increased thereby causing possible harm or death to the occupants through asphyxiation. Always use these appliances with proper ventilation.



DANGER

IF YOU SMELL GAS, YOU SHOULD IMMEDIATELY:

Extinguish any open flames, pilot lights, and all smoking materials. Do not touch or operate any electrical appliances or switches. Immediately shut off the gas supply at the main tank valve or supply connection. Open doors, windows, and other ventilation openings. Exit the RV to allow entrapped LP gas to dissipate. Have the LP gas system checked to locate and fix the source(s) of the leakage.



WARNING

DO NOT APPLY 110 VAC POWER to or LIGHT the water heater until after the water heater is filled with water and the water lines and heater tank are purged of any trapped air. Failure to do so will damage the water heater and may cause additional damage to the motorhome.

WATER HEATER

Before the water heater is to be used, fill the fresh water system and purge the water lines to and from the water heater by opening all the hot-water faucets until water steadily flows from each one and no “spurting” or “hissing” sounds are heard.

The water heater uses either the LP gas system or the 120-volt AC electrical system to operate the heater. Proper and safe operation of the water heater requires that all safety information provided in the owner’s manual be read and understood before placing the water heater in service. Take the time to become familiar with this manual (provided in the Owner’s Information Package).

The water heater is designed for operation either with LP gas or 120-volt AC electricity.

NOTE: When you turn “on” the switch for the water heater the middle red button will light up. It will go off after several seconds—this means the water heater is lit. However, if the light stays illuminated, then that means the water heater has not ignited.



LP GAS – ELECTRONIC IGNITION OPERATION

1. If the water heater fails to operate because of high water temperature, the heater will go into a lockout condition (indicator light “on”). When the water eventually cools, reset the system by turning the switch to the “off” position for at least 30 seconds, then turn the switch back “on.”
2. If a lockout condition persists, contact your authorized dealer.

120- VOLT AC ELECTRICAL OPERATION

1. For electrical operation, use the Water Heater switch found on the master control panel in the galley of the coach.
2. Completely fill the water heater with water and purge the hot-water lines of any trapped air.
3. Turn the Water Heater switch “on.” NOTE: Turning the power “on” to the water heater without having previously covered the water-heating element with water may burn out the element and void the warranty.
4. After a while, check the water heater for proper operation; the water temperature should be approximately 140°F (60°C).

1. If the manual-reset, high-temperature-limit switch should trip the circuit breaker; reset the switch by depressing the reset button--use a pencil or other non-metallic object to depress the reset button. If the high-temperature-limit switch should again trip the circuit breaker, contact an authorized service technician or an authorized dealer.
2. Both the electrical and gas operations of the water heater may be used simultaneously to reduce recovery time of heating water up to desired temperature.

For general maintenance of the water heater or specific information about select steps in operating the water heater, please refer to the owner's manual for this appliance contained in the Owner's Information Package.



WATER HEATER STORAGE

Figure 5-6: Water Heater if the motorhome is to be stored during the winter months, the water heater should be drained to prevent damage caused by freezing water contained in the water heater.

To drain the water heater, first turn "off" all electrical power, turn "off" the LP gas going to the water heater, then turn "off" the water pump. Open both the hot- and the cold-water faucets to drain the water lines and open the drain on the water heater to drain the entire system.

When re-activating the water heater after the motorhome is taken out of storage, make sure that the entire water system, including the water heater, has been filled with water and the lines have been purged of any entrapped air before relighting the water heater. Failure to do so may allow the water heating element to be turned "on" before it is immersed in water; thereby, causing the premature failure of the heating element and voiding the warranty.

PRESSURE RELIEF VALVE

The relief valve for over-pressure and over-temperature conditions is located on the exterior of the water heater. This valve will operate if the water temperature reaches or exceeds 210°F or if the water pressure reaches or exceeds 150 psig.

Since the water system in the motorhome is a closed system when all water valves are shut, the water



heating cycle can raise the temperature and, consequently, the pressure, of the water in the water heater; thereby realizing pressure increases approaching 150 psig.

Should this pressure (i.e., 150 psig) be reached, the pressure-relief valve will begin “weeping,” that is, minor dripping or leakage from that valve until the pressure drops below 150 psig, at which time the pressure-relief valve will re-seat itself and restrict the water flow. This is normal operation and should not be a cause for alarm. Do not obstruct or block the pressure-relief valve in any way, as this would keep the valve from functioning normally and protecting the hot water system.

NOTE: WHEN WINTERIZING YOUR COACH, REMOVE THE WATER FILTER.

TRUMA AQUAGO@ LP GAS INSTANT WATER HEATER

Model: Truma AquaGo[®] basic (DLE60B) *

Truma AquaGo[®] comfort (DLE60C) *

* Patent Pending

Truma AquaGo[®] comfort plus (DLE60CP) *

*PLEASE REFER TO YOUR TRUMA WATER HEATER OWNER’S MANUAL FOR THE FIGURE PICTURES. *



WARNING

-If the information in these instructions is not followed exactly, a fire or explosion may result, causing property damage, personal injury or death.

- Do not store or use gasoline or other flammable vapors and liquids in the vicinity of this or any other appliance.

WHAT TO DO IF YOU SMELL GAS

- Evacuate all persons from the vehicle.
- Shut off the gas supply at the gas container or source.
- Do not touch any electrical switch or use any phone or radio in the vehicle.
- Do not start the vehicle's engine or electric generator.
- Contact the nearest gas supplier or certified service technician for repairs.
- If you cannot reach a gas supplier or certified service technician, contact the nearest fire department.
- Do not turn on the gas supply until gas leaks have been repaired.

Installation and service must be performed by a certified service technician, service agency, or the gas supplier.

1. Use with LP gas (propane) only. Butane or any mixtures containing more than 10% butane must not be used.
 - LP tanks must be filled by a qualified gas supplier only.
2. The nominal gas system pressure must be 10.5 in. wc.
3. Hot water can be dangerous, especially for infants, children, the elderly, or infirm. It can cause severe burns. Therefore:
 - Never actuate the pressure relief valve (Fig. 1-4) as long as the appliance is still hot.
 - Never actuate the Easy Drain Lever (Fig. 1-11) as long as the appliance is under water pressure and/or still hot.
 - Always check the water temperature before entering a shower or bath.

4. How long before hot water causes skin damage?

Temperature °F (°C)	Time before skin becomes scalded
155 (68)	1 second
148 (64)	2 seconds
140 (60)	5 seconds
133 (56)	15 seconds
127 (52)	1 minute
124 (51)	3 minutes
120 (48)	5 minutes
100 (37)	safe bathing temperature

- The water pressure on the inlet side must be limited to 65 psi (4.5 bar), otherwise internal components of the appliance will be damaged. On (city) water connections with a pressure higher than 65 psi (4.5 bar) a pressure regulator is strongly recommended.

Operating Instructions

Read and follow the "Consumer Safety Information" before operating the appliance.

WARNING SCALDING INJURIES CAUSED BY HOT WATER!

- Water temperatures over 127 °F (52 °C) can cause severe burns or scalding and extreme cases even death.
- Before using the hot water faucet or using the shower, allow the hot water to run until the water temperature no longer increases.
- Test the temperature of the water before placing a child in the bath or shower.
- Do not leave a child or an infirm person in the bath unsupervised.

HOW THE APPLIANCE WORKS

The appliance was developed exclusively for use in recreational vehicles (RVs).

The appliance is connected between the vehicle's fresh water supply and its hot water plumbing system.

It is powered by propane and a 12 V power supply. The ventilation grille on the access door allows combustion air to flow into the appliance and exhaust gas to flow out.

When the appliance is switched on, the water will be heated on demand:

- A volume-flow sensor in the appliance detects when the hot water faucet has been opened and the volume flow is greater than approximately 0.4 gallon/min (1.5 liter/min). The burner then starts automatically.
- The burner control continuously adjusts the heater output based on volume flow and inlet water temperature, so that the temperature at the hot water outlet is approximately 120 °F (49 °C). A temperature stabilizer is also installed in the appliance to minimize fluctuations of the outlet temperature.
- After some time, the maximum temperature at the faucet or in the shower is reached. The length of time will depend on the model (AquaGo basic, AquaGo comfort and AquaGo comfort plus) and variations in the water plumbing (length of pipes, insulation, circulation line, etc.).

Like in a home shower, a comfortable water temperature at the shower head is reached by mixing in cold water.

- When the volume flow is less than approximately 0.4 gallons/min (1.5 liter/min) and the faucet is closed, the burner is automatically switched off.

The AquaGo comfort and AquaGo comfort plus models are equipped with a circulation pump. The circulation pump as well as the burner are switched on automatically by the control unit in order to keep the water temperature above 102 °F (39 °C) in "COMFORT" mode and 41 °F (5 °C) in "ECO" mode.

NOTICE

Risk of damage in frost conditions. Refer to "Operations in frost conditions" on page 13 of the Truma owner's manual.

STARTING THE APPLIANCE

Danger of over temperature and toxic exhaust gases!

- Use with the LP gas (propane) only. Butane or any mixtures containing more than 10% butane must not be used.
- Keep the air inlet and exhaust gas outlet free of obstructions. Do not lean any objects against the water heater's access door or place foreign objects within 2 feet (61cm) of the access door.

WARNING DANGER OF COMBUSTION, PERSONAL INJURY AND DAMAGE TO THE RV!

- Keep the area around the appliance free from combustible materials, gasoline, and other flammable vapors or liquids.
- Switch the gas supply and the appliance off:
- If anything seems to be out of the ordinary.
- If you smell gas.
- If you move the RV.
- Before entering the gas station. - Before entering a tunnel.

OPERATING PROCEDURES

NOTICE Risk of damage in frost conditions

In frost conditions, ambient temperatures below 39 °F (°C), there is a risk that water in pipes, faucets and appliances could freeze. This can cause considerable damage.

- Before you fill water into appliances and parts that transport water, you must heat the installation area sufficiently so that the water cannot freeze.

Proceed as follows to fill the appliance with water:

1. Close open bypass lines (if present). Insert the water inlet filter or heating cartridge – if removed 2, 7, 9, 11.
2. Turn on fresh water supply or switch on the water pump.
3. Fill the plumbing system.
 - Open all the water-release points, e.g., cold and hot water faucets, showers, toilets.

IT IS IMPORTANT THAT YOU BLEED THE WATER SYSTEM BEFORE STARTING THE APPLIANCE.

- Once water flows, the plumbing system is vented. Close the water-release points.
4. Start the appliance as follows:
 - Make sure that the LP gas supply is turned on.
 - Switch on the 12 V power supply (RV).
 - Open the access door (refer to “Opening the access door” on page 8 in the owner’s manual)
 - Switch on the appliance at the POWER switch. Refer to “Switching ON the appliance” on page 11 in the owner’s manual.
 5. AquaGo comfort /AquaGo comfort plus
 - Select the desired operating mode (refer to “Operating modes (control panel)” on page 11 in the owner’s manual.
 - Close the access door (refer to “Opening the access door” on page 8 in the owner’s manual.
 - There may be a variation between the temperature delivered to from the appliance and the temperature at the faucet due to water conditions or the length of pipe from the appliance.

- The presence of a flow restrictor in the hot waterline may limit the water flow.
6. How to use hot water:
- To obtain the desired water temperature at the faucet or in the shower, mix cold and hot water.
 - Particularly when showering, wait until the water temperature has stabilized before entering or allowing other people or animals to enter the shower.

Switching ON the appliance

1. Open the access door
2. To switch on the appliance, switch the POWER switch to one of the two 'ON' positions.

Both ON positions on the POWER switch have the same function. Choose your preferred position.

- When the green power ON LED 1 is lit, the appliance is switched on.
- If the red error code LED 2 is lit /flashes, there is a fault warning (refer to "APPENDIX A – error codes" on page 37 in the owner's manual).

AquaGo basic

- The operating mode is set automatically to "BASIC".
- The appliance is now ready for use.
- Water temperature at the outlet is approximately 120 °F (49 °C)

AquaGo comfort/comfort plus

- The appliance is now ready for using the control panel inside your vehicle. Refer to 'Operating modes (control panel)' on page 11.

Operating modes (control panel)

AquaGo comfort/AquaGo comfort plus

A control panel to select the operating mode included with the delivery from serial number DLE60X(X)27100000 with the rotary switch you can choose between the following operating modes:

ECO

The appliance is now running in energy saving mode.

- Water temperature at the outlet is approximately 120 °F (49 °C)
- Prevention of freezing by using propane gas. The temperature in the appliance is automatically kept above 41°F (5°C).
- During operation, the yellow status LED 3 is lit.

COMFORT

The appliance is now running in a mode that provides rapid availability of hot water.

- Water temperature at the outlet is approximately 120 °F (49 °C).

- Stand by heat. The temperature in the appliance is automatically kept above 102°F (39°C)
- During operation, the yellow status LED 3 is lit.

Stand-by. The appliance is not running in any operation mode.

- The yellow status LED 3 is off.
- To switch the POWER and gas supply refer to “Switching OFF” the appliance on page 12 in the owner’s manual.

Switching OFF the appliance AquaGo comfort /AquaGo comfort plus

1. Set the contro Panel to “Off”.
2. Open the access door.
3. Switch off the appliance at the POWER switch -the green ON LED extinguishes.
4. Close the access door.
5. If the appliance is not needed, turn off the gas supply to the appliance.

If you intend to put the RV into storage or turn off the appliance during freezing temperatures, refer to “Winterizing” on page 14 in the owner’s manual.

Operating in frost conditions Ambient temperatures below 39°F (4°C)

NOTICE

Risk of damage in the frost conditions.

In frost conditions, ambient temperatures below 39°F (4°C), there is a risk that water in pipes, faucets and appliances could freeze. This can cause considerable damage.

- If the appliance is not to be used in frost conditions, you must winterize the appliance. Refer to “Winterizing” on page 14 in the owner’s manual.
- Winter operation will not protect the RV’s entire water system. Water lines, faucets, water tanks and the external water valves and the vehicle must be heated separately.
- The RV must be designed for winter use/freezing conditions.
- The water pipes in the RV must be ice free to operate the AquaGocomfort/AquaGo comfort plus in winter. Otherwise, there is no water flow and the appliance does not start.

NOTICE

Gas must not be used for heating while the vehicle is in motion. Ask your dealer/vehicle manufacturer about options for heating your RV while driving.

WINTERIZING

NOTICE: Severe damage to the water system components and the appliance

Any damage caused by freezing or an unsuitable winterizing fluid will not be covered by warranty.

- Follow the recommendations if the appliance will be stored under freezing conditions or for an extended period of time.
- Winterize the appliance at the start of the winter season or before traveling to a location where freezing conditions are likely.

If your RV is equipped with a bypass around the appliance, separate the appliance from the water system with the bypass.

WINTERIZING THE APPLIANCE

- To winterize the appliance, you must drain all water from the appliance. To do this we advise the following steps:
- Remove the water from inlet filter or heating cartridge. See “Draining the water and cleaning the water inlet filter” on page 15 in the owner’s manual steps 1-8.
- Let water completely drain from the appliance. This can take several minutes.
- Do not insert the water inlet filter or the heating cartridge into the appliance during winter – if the appliance is not used.
- CAUTION Danger of crushing/pinching of fingers when the Easy Drain Lever is closed! Never put fingers between the Easy Drain Lever and latch.
- Close the Easy Drain Lever and the access door.

Once the water has been drained, the appliance is protected against freezing conditions.

WINTERIZING THE RV WITH A WINTERIZING FLUID

- Winterizing the RV with a winterizing fluid is only possible with an installed bypass kit (not in cope of delivery)
- Refer to “Connection diagrams on page 31 in the owner’s manual for all letters referred to in the following description.

WINTERIZING AQUAGO BASIC /AQUAGO COMFORT

1. Close valves A and B.
2. Open valve C

3. Drain the appliance (Draining the water and cleaning the water inlet filter” on page 15).
4. Flush the RV’s water system with a suitable winterizing fluid according to the supplier’s or RV manufacturer’s guidelines.

WINTERIZING AQUAGO COMFORT PLUS

1. Close valves A, B and E.
2. Make sure that valve D remains in the closed position.
3. Open valve C.
4. Drain the appliance (“Draining the water and cleaning the water inlet filter” on page 15.
5. Flush the RV’s water system with a suitable winterizing fluid according to the supplier’s or manufacturer’s guidelines.
6. Close all faucets (if open).
7. Open valve D.
8. Wait until winterizing fluid has drained. Collect escaping fluid in a suitable vessel.
9. Close valve D.

Rinsing the water system

- You will need about 8 gallons (30 liters) of water to rinse the water system.
- Dispose of (used) decalcification solution in accordance with local laws and regulations.

Tasks within the RV

- Open all water-release points, e.g., hot water faucets, showers, toilets.
- Run the water until the status LED 3 on the control panel goes out.
- Set the control panel to “Off”.
- Close all water release points.
- Turn OFF the water supply or switch OFF the water pump.
- Open a hot water faucet to relieve pressure in the system.

To make sure that the appliance and the water pipes contain no decalcification agent, empty the water system again and refill it.

Tasks outside the RV

- Switch the appliance OFF at the POWER switch (red error code LED 2) flashes before it switches off.
- Drain the water system (refer to “Draining the water and cleaning the water inlet filter” on page 15 steps 1-8 in the owner’s manual.
- Install the water inlet filter. (referring to step 9). Or antifreeze cartridge if electric antifreeze kit is installed.
- Switch ON the appliance at the POWER switch.
- Insert and close the access door (refer to “Closing the access door “on page 9).

You have to switch the appliance off and on to unblock decalcification and enable further operation.

Filling the water system

Tasks within the RV

- Turn on fresh water supply or switch on water pump.
- Fill the water system.
 - Open all water-release points, e.g. hot water faucets, showers, toilets.
 - Once water flows evenly, the water system is vented.
 - Close the water-release points.
- Before you use the water system and the appliance, check the color of the water at all faucets. - Slightly red> rinse again.
 - Clear -> decalcification is finished.
- Remove the warning signs" Caution decalcification in progress".

WAY FARE R

ENTERTAINMENT

Chapter

6

NOTE:

RUNNING THE TELEVISION(S) ON INVERTER POWER FOR PROLONG PERIODS OF TIME WILL DRAIN THE MOTORHOME BATTERIES.

TELEVISION(S)

Televisions will need to be reprogrammed each time the motorhome is moved in order to pick up

The televisions are powered by 120 volt AC electricity; therefore, the motorhome must either be plugged into with the 30 AMP shore power cord, or generator. The entertainment system is also connected into the inverter would permit the 12 volt DC power to be converted into 120 volt AC for the television(s).

Standard Cable / satellite atripod hookup is located on the driver's side rear cargo compartment on Prewire for a roof satellite is provided and located on the roof of the motorhome. Consult an authorized dealer or the Owner's Information Package included with the motorhome.

Detailed operation of the television(s) is provided in the accompanying owner's manuals found in Tiffin Motorhomes Dealership or Tiffin Motorhome incorporated in Winfield AL

RADIO CONTROL

The controller located in the bedroom and provider AM/FM tuning



WAY FAREER

CABINETS AND FURNITURE

Chapter

7

CABINETS

Your Wayfarer contains cabinetry installed throughout the entire motorhome from the driver's area, through the kitchen/dining areas, and back into the bedroom.

The cabinetry has been designed and built to provide ample storage space, to be easily accessible, and to be conveniently located to support the areas of concern.

Construction of these cabinets incorporates various hardwoods, raised panels, cabinet doors, and supports. Door pulls, handles, and knobs are installed in a style complementing the particular décor of each Wayfarer so that an aesthetically-pleasing, as well as fully functional, storage capacity is realized.

For the many floor plans available in the Wayfarer product line, cabinet design (Figure 7-1) has been optimized to provide maximal storage for each and every floor plan available. Accordingly, the Wayfarer can readily accommodate the routine materials, supplies, and customer-specific items desired for any travel requirements.

Figure 7-1: Living Room Cabinets

These cabinets are designed to contain stored supplies quite securely during travel to minimize or eliminate the possibility of shifting or spilling of cabinet contents during travel. But, when the motorhome is parked, all stored items are readily available in the cabinets for the convenience of the users.

As the storage requirements will vary somewhat from one floor plan to another, general observations can be made about the Tiffin-supplied cabinetry which may or may not be applicable for your specific Wayfarer configuration.

Cabinets are provided in the kitchen/dining area to accommodate the routine cooking utensils and groceries normally desired for travel. Storage space within these cabinets has been designed to accommodate the typical sizes and configurations of food supplies (e.g., cereal boxes, condiments, canned goods, bottled liquids) normally taken on travel trips.

Based on Tiffin Motorhomes' extensive experience with travel requirements of the seasoned motorhome users and from Tiffin Motorhomes' own research and development in cabinet-design requirements, the cabinets offer the greatest storage capacity possible. In the bathroom and bedroom, additional cabinets are available for storage of sundries and toiletries specific to these areas.

In the kitchen, a color-coordinated countertop is provided on top of the floor-mounted cabinets. To maintain the appearance of the countertop, clean with a damp cloth. If spotting occurs, clean the



countertop with a damp cloth and a mild liquid soap. Should some dried-on residue still be present wet a damp cloth moistened with the liquid cleaner stand directly on top of that residue for 15-30 minutes to loosen the residue, then clean that spot accordingly.

Please note that strong chemicals, solvents, and cleaners (e.g., oven cleaner) may damage the surface; so do not use any products not specifically designed for countertop cleaning.

The countertop (Figure 7-2) may be physically damaged, too, if proper care is not taken. Do not cut anything (e.g., vegetables, fruits) directly on the countertop; rather, use a cutting board on top of the countertop to provide necessary protection. Excessive heat may also damage the countertop; therefore, any pots or pans taken directly from the range or oven should not be placed directly on the countertop; rather, use trivets or some other form of fireproof heat insulators to hold very hot pots or pans on the countertop.

Figure 7-2: Counter Tops

All drawers are equipped with metal slides to provide additional load-bearing strength for the drawers and to permit effortless opening and closing of those drawers, even when they are fully loaded. These metal guides have a slight “locking” action, when closed. To open those drawers, slightly lift up on the drawer handle and then pull the drawer open.

To close, push the drawer closed until it “clicks” back into place (i.e., the locking action is engaged).

As this cabinetry is typically of furniture-grade quality, any commercial furniture polish or cleaner can be used. Do not try to soak these wooden surfaces with any water or any other liquid; be sure to wipe up spills or residues of any fluids that contact these surfaces to preclude any staining or discoloration of the cabinet surfaces.



KITCHEN, LIVING & DINING AREAS

Sofa Booth

On the Wayfarer floor plan, a built in dinette booth (Figure 7-3) or sofa are available. Both provide additional storage under the seat area, in addition to providing additional sleeping facilities.

Dinette Instructions

1. Remove seat back and side cushions.
2. Slide seat bottoms back.
3. Pull the lever underneath the table to release the table down.
4. Reinstall the seat back cushions and back rests to make up the mattress for the bed.



Figure 7-3: Work Area/Eating

The living room contains a tri-fold sofa (Figure 7-4) which converts into a bed. The sofa is custom coordinated with the décor of the motorhome. To convert the sofa into a bed, follow these directions:

1. Remove the accent pillows
2. Lift bottom cushions and pull toward you.
3. Support legs are located in the trifold section. Be sure to lower the legs and secure support.

Figure 7-4: Tri-fold Sofa



SOFA

The driver's seat is manually operated and has swivel features. When the motorhome is parked, the driver's seat can be swiveled to face into the living room. To swivel this chair, first extend the slide-out room. Then move the chair backwards as far as possible to gain clearance from the steering wheel. Now the chair can be swiveled without interference. In a comparable manner, the passenger's seat is also a manually operated seat having essentially the same controls as that of the driver's seat and it is operated accordingly.

SLEEPING AREA

If a décor-coordinated, quilted bedspread with accessorized pillow shams and accent pillow(s) (Figure 76) are included with the bedroom suit, it is recommended that the bedspread be only dry-cleaned to preserve the quality of the bedspread for the longest time possible.

Treatment of the bedspread with any of the stain-resistant sprays (e.g., Scotch Gard, etc.) will also make the bedspread more resistant to the possibilities of stains and fabric damage and, thus, provide many years of dependable service.



Figure 7-6: Fold Down Bed

WAYFARER

STRUCTURAL FEATURES

Chapter

8

STRUCTURAL FEATURES

CHASSIS FEATURES

The chassis of your Tiffin Motorhomes Wayfarer was built by and is warranted by Mercedes Motors. The operating instructions for that chassis are included in the Chassis Owner's Manual which is provided with your Wayfarer and is a part of the Owner's Information Package furnished to you by your Tiffin Motorhomes dealership.

Before you begin using your Wayfarer, please read and follow all recommendations for the proper care, operation, and maintenance of the chassis—this will assure you of pleasant, trouble-free use of your vehicle. Should you have any questions about the chassis, however, you should contact your chassis manufacturer as noted in the literature described earlier.



WAYFARER

ELECTRICAL FEATURES

Chapter

9

GENERAL INFORMATION

There are two electrical systems in your Wayfarer motorhome. These are the 12-volt DC (VDC) system and the 120-volt AC (VAC) system. Most standard appliances require the 120-VAC system, while the majority of the lighting systems used in the Wayfarer use the 12-VDC electrical system.

The electrical power for the 12 VDC system is supplied by the batteries of the Wayfarer. Those batteries are charged by a power converter. The alternator also charges the batteries when the engine is running.

The electrical power for the 120 VAC is supplied by the 30 AMP shore power cord when the Wayfarer is connected to an external power source or when the on-board electrical generator is in operation. The inverter can also supply 120 VAC electrical power (to limited outlets and limited appliances) the items onboard the Wayfarer are powered by the inverter are limited to Televisions and Refrigerator —the inverter transforms the 12 VDC electrical power from the batteries into the 120 VAC electrical power needed for the basic appliances.

To connect the Wayfarer to an external source of 120 VAC electrical power, it is first recommended that main 30-amp circuit breaker is in the “off” position. This is done to prevent any power surge upon connecting the motorhome to the external power source. Then unwind the power cord from the electrical compartment located in an external compartment. The standard, flexible, power cord supplied with the Wayfarer is designed to handle 30 amperes. Make sure that the pins in the male end of the plug are oriented correctly so they match the power cable, and they are in good condition (i.e., aren’t bent or damaged).



CAUTION

Failure to turn off the 120 VAC appliances when starting or stopping the generator may damage the transfer switch and/or electrical appliances.

Note: Do not attempt to use any electrical adapters to convert the provided 30amp power cord, as this will damage electrical components inside the motorhome.

If there is a circuit breaker switch at the “plug” end of the power cord, that breaker should be turned “off” before making the connection. Insert the plug into the mating outlet and then turn the circuit breaker “on.” Close and lock the electrical compartment door to protect the contents and to keep them clean and dry. Close the cover on the power box, if so equipped, to avoid an unintentional disconnection and to keep the contents clean and dry. Then switch the main breaker to the “on” position.

ELECTRICAL FEATURES

When properly connected, the 120 VAC system provides power to all the 120 VAC circuits and outlets when the main breaker is turned “on.”

CIRCUIT BREAKER BOXES



CAUTION

- Careless handling of electrical components can be fatal. Do not touch or use electrical components or appliances while feet are bare, while hands are wet, or while standing in water or on wet ground.
- Do not touch an extension cord to the utility power cord.
- Avoid overloading circuits and replace fuses or circuit breakers with those of the same size and amps only. DO NOT use a higher rated fuse or breaker.
- Do not plug the utility power cord into an outlet that is not grounded.
- Do not adapt a plug to connect to a receptacle that it is not designed for.
- Be sure that all electrical appliances used inside the motorhome contain three-prong plugs for proper grounding.
- Use caution when handling or working near electrical storage batteries.
- Always remove jewelry and wear protective clothing and eyewear when working on an electrical matter.



For the Wayfarer, the 120 VAC and 12 VDC breaker boxes are located in the bedroom.

The circuit breakers and fuses are installed to protect the electrical system of the

Wayfarer from any overloads. Do not attempt to change the electrical circuitry or to add appliances yourself.

Please consult an authorized Tiffin Motorhomes Dealership or Tiffin Motorhomes, incorporated in Winfield AL to determine whether any changes you desire are appropriate and acceptable.

Tiffin Motorhomes' qualified staff of electricians can readily determine whether any changes sought (e.g solar, radio, amateur radio, satellite television receiver, personal computer system, and the like) are possible or not and can advise you on how best to realize these enhancements.

Please note that the 12 VDC fuses and breakers are located in a separate compartment adjoining the 120 VAC breakers. Fusing is provided for the following 12 VDC CIRCUITS: Refrigerator power, Radio power, HD Antenna / Satellite Booster Power, and Thermostat Power. When the ignition is on, the chassis batteries and house batteries will automatically merge to charge batteries when vehicle is in operation. NO SWITCH.

BATTERY DISTRIBUTION CENTER

The motorhome is equipped with a 12 VDC battery distribution center, located in the coach's battery compartment. The center has a 200amp main coach disconnect / breaker which will turn off all 12volt battery power to the motorhome. There is also (2) fuses of 250amp, and 60amp which distributes the 12 VDC power to system components within the motorhome.



When the 200 amp 12 VDC main circuit breaker is shut down or electrically tripped, it must be manually reset. This breaker protects the slide-outs, the AC ignition, the electric step, the 30-amp ignition system, and the 12 VDC disconnect system. As needed, manually reset the circuit breaker or breakers.

Be careful when working around these connections as an accidental electrical short to ground (i.e., momentarily connecting the “positive” or “hot” terminal to any part of the chassis) can be hazardous and harmful.

To access the battery distribution center, open the access panel on the steps. When access to the batteries are no longer needed, close and securely fasten the access cover to place these steps back in service.

BATTERY INSPECTION AND CARE

The motorhome batteries which constitute the 12 VDC system are contained inside the motorhome entrance step well.

To access these batteries, open the access panel on the steps. When access to the batteries is no longer needed, close and securely fasten the access cover to place these steps back in service.



Figure 9-2: House Batteries

When batteries are not used for extended periods of time, they will gradually lose their electrical charge. Therefore, it is necessary periodically to recharge the batteries to increase the operational lives of the batteries. It is also necessary to check the external condition of the batteries on a regular basis.

Look for cracks in the battery case and cover. Check the vent plugs and replace them if they are cracked or broken. Keep the battery clean. Since accumulations of dirt and acid residue around the battery terminals may provide an electrical path for discharging the battery, the area around the terminals should be cleaned periodically. One can use an old toothbrush and a sparse amount of a diluted solution of baking soda (sodium bicarbonate) and water (distilled or de-ionized, preferred; tap water, acceptable) to clean and neutralize any acidic build-up around the battery terminals. If there is any foaming on the top of the battery, this indicates that acidic residues are being neutralized. Rinse the cleaned areas thoroughly with distilled or de-ionized water (tap water is okay, too).

Avoid getting the baking-soda solution into the battery fill plugs to each battery cell; this would drastically reduce the effectiveness of the battery (by neutralizing the sulfuric acid in the battery cells) or, worse, “kill” the battery. Dry the battery cables and terminals to prevent corrosion; to protect those terminals further, use a plastic ignition spray on the terminals. Do not use grease on the terminals, especially on the metal-to-metal connections, as grease may act as an insulator and keep the battery electrical power from entering the cables.

If the batteries are not going to be used for an extended period of time, they should be removed from the Wayfarer and stored in a warm, dry place. IT IS STRONGLY RECOMMENDED that this service be performed by a qualified service technician, as the process is usually too complicated for the average owner to perform. For those who may wish to perform this service themselves, the following procedure is described: Mark the battery cables (“+” sign or “red” for the positive cable; “-” sign or “black” for the negative cable) so that they can be properly reconnected again later. These batteries would require periodic recharging to maintain their full charge.

Following manufacturer’s recommendations as found in the Owner’s Information Package, periodically check the fluid levels in all the cells of the batteries (be sure to use safety eyewear during this process) and fill those that are low with water (distilled or de-ionized water is preferred; DO NOT use tap water). Don’t overfill the cells; follow the filling directions exactly. This battery checkup should be done on a regular basis to realize the fullest service possible from the batteries over the longest time possible. If the Wayfarer is to be stored for an extended period of time, the 12 VDC battery system should be disconnected—this procedure will prevent unnecessary drain and corrosion of the batteries and their terminals.

NOTICE

Disconnect the 120 VAC electrical power cord and the negative terminal from the coach batteries while working on the Wayfarer electrical system.

NOTICE

If the Wayfarer ever requires any welding operations on the frame first disconnect the chassis batteries. Failure to do so will destroy all the chassis computer systems.



WARNING

Remove rings, metal watchbands, and any other metal jewelry before working around batteries. If any metallic object (tool, jewelry, etc.) contacts the positive battery terminal or any connection made to that terminal AND also contacts the negative terminal or any of its connections, a SEVERE ELECTRICAL SHORT will occur which could result in an explosion, fire, and/or personal injury. Lead-acid batteries contain diluted sulfuric acid which can be dangerous; avoid direct contact with any battery fluids. Wear eye protection.

120 VOLT (VAC) AC RECEPTACLES

Your Wayfarer motorhome is equipped with several 120 VAC receptacles (Figure 9-5) located throughout the interior of the motorhome.

These 120 VAC receptacles are of the “three-prong” variety; the third prong being a grounding pin which provides adequate grounding to protect one from any electrical shock.

For these receptacles to work properly, do not use an adapter, cheater, or extension cord which defeats the function of the grounding pin. For the same reason, never remove or bend away the ground prong or pin from any three-prong AC plug so that it would fit a two-prong AC receptacle (i.e., an ungrounded AC receptacle).

Never operate the Wayfarer if there is an electrical short present, as an electrical short may deliver an electrical shock to anyone coming in contact with the exterior of the unit.

If you should feel even the slightest of electrical shock, immediately disconnect the unit from the 120 VAC power source and locate the electrical fault (i.e., typically, it is a break in the grounding circuit).

Do not reconnect the 120 VAC power until after that electrical fault is fixed— the grounding circuit must be continuous from the frame to the distribution panel, to the power cord, and to the earth ground so that electrical-shock protection is

realized.

Figure 9-3:120 VAC Receptacle



USB RECEPTACLES

The Wayfarer is equipped with USB ports conveniently located on the front dashboard and in the bedroom area as well as on the passenger console. These ports allow for easy access when charging cell phones, laptop computers, iPods, iPads or other tablets.

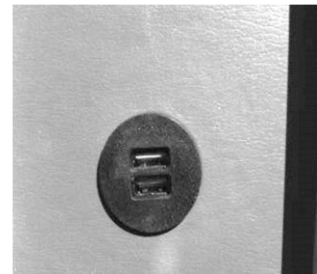

Figure 9-4: USB Port

GROUND-FAULT-CIRCUIT-INTERRUPT RECEPTACLES

In the bath areas, there is 120 VAC GFCI receptacles (Figure 9-5) which provide greater protection against inadvertent electrical shocks.

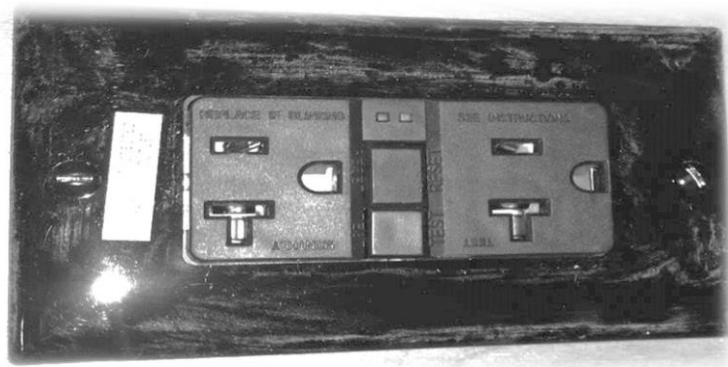

Figure 9-5 GFCI Receptacle

These specialized GFCI receptacles provide both overload and short-circuit protection for the user. All of the electrical receptacles on the “general” branch is GFCI protected through the bathroom GFCI. Consequently, if an appliance plugged into an outlet that is not on the inverter, check for a tripped GFCI in the bathroom.

All GFCI-protected receptacles are marked as such, but only one of them may have two pushbuttons on the receptacle (as shown in the picture). The upper pushbutton is a “test” button which can be used to assure that the GFCI function is working—all one need do to test this function is to push that upper button: There will be a momentary “click” and the

circuit will be disconnected (i.e., no power is available at the GFCI-protected receptacles). To reset this GFCI breaker, push the lower button (the “reset”

These receptacles protect the user from ground faults between an electrically “hot” wire and ground. The GFCI will not reduce the shock hazard if the short is between a neutral and “hot” wire, or two “hot load” wires. The GFCI should be tested at least once a month. The 120 VAC electrical system must be “on” for the GFCI to be tested. To test the GFCI the reset button needs to be pushed in fully before starting the test. Push the test button; this will cause the reset button to pop out which means that the protected circuits have been disconnected. Push the reset button back in until a “click” is heard—this will re-activate the protected circuit. If the GFCI is working properly, the reset button will remain in the “in” position.

INVERTER (1000 Watts)

1. Invert 12 VDC power into 120 VAC power when 120 VAC is not available. The inverter can create 120 VAC to power the entertainment system (e.g. TVs, Blu-ray player and refrigerator when 120 VAC power is not available.



Figure 9-7 Inverter

The inverter will transfer or pass 120 VAC power to its loads when plugged into shoreline or the generator is running.

The inverter switch is located on the central control panel. This switch allows quick inverter ON/OFF control and a quick indication of the inverters power status.

NOTE: Leaving the switch on for extended times can drain the batteries.



Figure 9-8 Inverter Switch

ELECTRICAL GENERATOR

The electrical generator is a 3.2 KW conveniently located in one of the side compartments in the Wayfarer motorhome. Prior to starting or stopping the generator (Figure 9-9), make sure that all the 120 VAC appliances are turned "off."

After the generator has been started, wait until the transfer switch has connected before turning "on" any of the appliances.



The generator can be started from either the remote-start switch located on the central control panel or directly at the generator itself. The hour meter installed on the generator records the number of hours of operation of the generator motor—

this elapsed time is needed for observing necessary maintenance schedules on the generator.



CAUTION

Failure to turn off the 120 VAC appliances when starting or stopping the generator may damage the transfer switch and/or electrical appliances.



AUTOMATIC TRANSFER SWITCH

The automatic transfer switches or (ATS) transfers 120V AC power from shore line normal power or generator power to the coach's main electrical distribution panel. The ATS has a delay of around 5 seconds before switching power to shore line, and a delay of around 30 seconds before switching power to the generator. The ATS is located on the driver's side rear cargo bay. This appliance has limited surge protection capabilities.



If the unit is plugged into shore but no power to coach, then make sure the shore outlet has power. If power is present, this may indicate the unit is sensing an open neutral condition. Start the generator, if the power is restored, then either the shore plug or the outlet may be defective (the neutral line may be broken.)

If there is no power to coach from shore or generator, then check the generator circuit breaker. If the circuit breakers are not tripped in the generator or the coach, the transfer box may need to be replaced. For more detailed information on the automatic transfer switch, please refer to the specific owner's instructions found in the owner's information package.



CAUTION

Service to this box is to be performed by a qualified technician. DO NOT attempt to remove cover unless shore cord is unplugged, and generator is off.

NOTICE

Be sure air conditioning units are off before connecting or disconnecting to or from shore power..

CIRCUIT BREAKERS

The circuit breakers (Figure 9-9) are located in the main 120 VAC distribution load center located in bedroom.

When the circuit breakers are shut down or electrically tripped, they must be manually reset. As needed, manually reset the circuit breaker or breakers as shown in the accompanying figure.

The panel has a main 30amp breaker which turns off all incoming power to the panels branch breakers. All branch breakers are labeled as to their function. This panel also has 12 VDC fuses, which are labeled as to their function.



CONVERTER

A converter is provided as a standard feature on the Wayfarer located as part of the main

120volt distribution load center (Figure 9-8) located in the bedroom. This converter takes 120 VAC power and transformers that into 12 VDC power when 120 VAC is available. The converter will create 12 VDC to charge the house batteries when 120VAC power is available from either the shoreline or generator power.

FUSES

The electrical circuits protected by the under-dash fuse block include: headlights, panel light for dashboard, tail lights, turn signals, cruise control, engine computer, accessory fuses, heater and dash air conditioning. Additionally, there is another chassis fuse panel which works in conjunction with the chassis fuse panel and provides comparable protection for the above-listed circuits.

Located beneath the access panel on the dashboard are two additional fuse panels; these panels protect the following electrical systems: mirrors, optional satellite jacks, camera, optional power windows, dash trim, lighter, map light, optional power seats, and radio.

Should there be any electrical failure of these components or systems, the first troubleshooting procedure should be to check the fuses and have available replacements to replace any blown fuses, as may be warranted.

As an aid to extracting and/or installing fuses in the fuse blocks, one may wish to buy an inexpensive fuse puller at any electronics or hardware store. This tool makes the installation or removal of fuses much easier and prevents inadvertent damage to nearby fuses or the fuse block itself.

SEVEN-PIN TOWING CONNECTOR

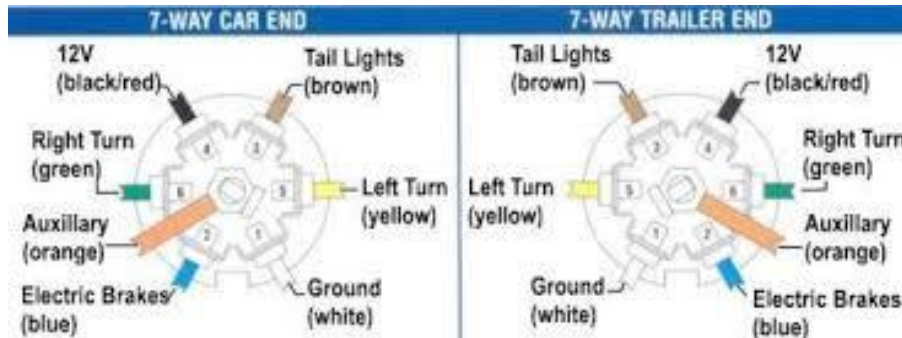

Your Wayfarer is equipped with a standard, 7-pin connector near the towing hitch at the rear of the motorhome to supply the necessary circuitry to control a towed vehicle.

Figure 9-10: Seven-Pin Towing Connector

The wiring of that connector is shown in the accompanying diagram (see Figure 9-10).

Make sure that any cable from the vehicle to be towed is wired correctly to mate properly with the connections shown in the connector. If in doubt about proper wiring, have a qualified service technician prepare and install the necessary cable to mate with the 7-pin connector on the motorhome to assure proper operation subsequently when any vehicle is actually towed by the motorhome.

When the towed vehicle is uncoupled from the motorhome and the cable is disconnected from the 7-pin connector, be sure to close the spring-hinged cover plate on the connector to protect the contact pins from dirt or debris. In a similar manner, protect the cable end from similar damage, weather, or debris—one such method could be to place the connector end in a heavy-gauge plastic bag (e.g., polypropylene, polyethylene, etc.) and secure the bag tightly around the cable with a stout elastic band or tape and then mount the secured cable in a manner to keep it both from mechanical damage and water intrusion.

When the towed vehicle is again coupled to the motorhome via the towing hitch and the cable is again connected to the 7-pin connector, make sure the resultant connection is tight and solid so that the connection won't jar loose during use. Several supplemental methods to secure that connection have been used; some of which include securing the connection with a strong rubber band or with velcro type fasteners to provide a supplemental mechanical backup to the actual electromechanical connection. Should a conversion adapter to convert the round, seven-pin connector to a flat, four-pin connector be needed; such an adapter may be purchased from any RV after-market store.

ELECTRICAL DIAGRAM

25JW

JW FLOORPLAN

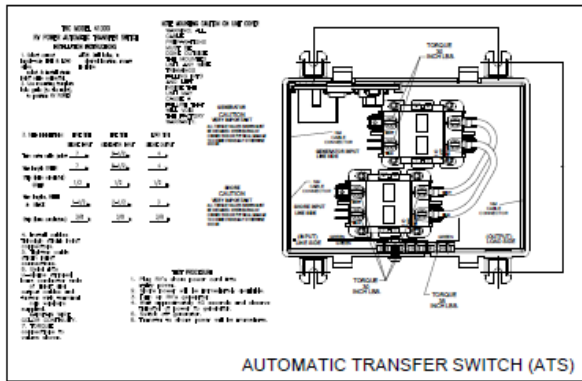
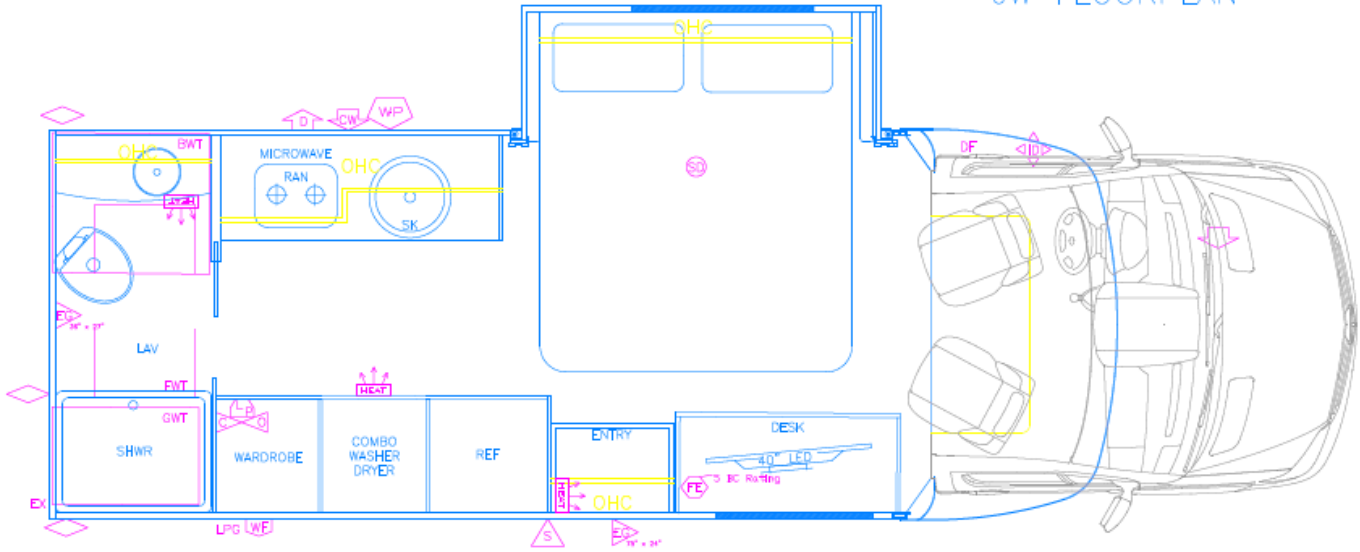

WAYFARER 25JW LOW VOLTAGE DISTRIBUTION

WARNING:
THIS UNIT IS POWERED BY 12V BATTERIES. CAUTION MUST BE USED WHEN RECONNECTING. USE THE FOLLOWING DIAGRAM WHEN SERVICING OR REPLACING BATTERIES.

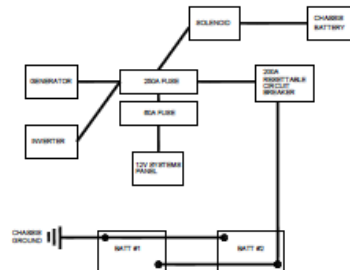

Heating Duct Assy.



ITEM	QTY	DESCRIPTION	PART NUMBER	QTY	UNIT
1	1	Furnace	6220	1	Each
2	1	4" to 2" Reducer	1397	1	Each
3	4	4" Duct Collar	6117	1	Each
4	1	2" Duct Tee	5067409	1	Each
5	1	2" Duct, Length 48"	1408	48	in
6	1	2" Duct, Length 143 1/2"	1408	143 1/2	in
7	1	4" Duct, Length 36"	1411	36	in
8	1	4" Duct, Length 36"	1411	36	in
9	1	4" Duct, Length 60"	1411	60	in
10	1	2" Duct, Length 24"	1408	24	in

WAYFARER

24 JW 12VOLT LOW VOLTAGE PANEL DIAGRAM



J-15 AWNING COMMON
J-15 AWNING COMMON

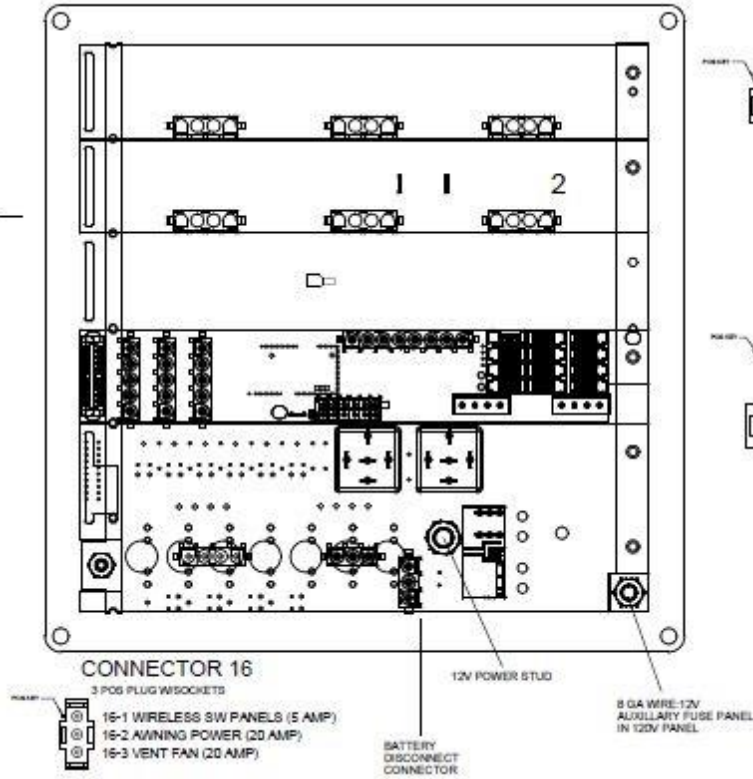
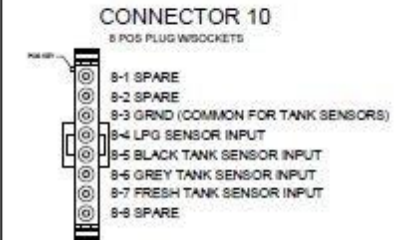
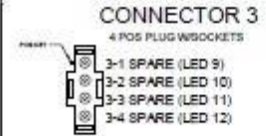

WAYFARER

EQUALIZER SYSTEM

Chapter

10

EQUALIZER SYSTEM

WARNINGS AND PRECAUTIONS

- Use the system in the intended manner. System forces and pressures can cause severe injury or death if used improperly or modified. Service work should only be performed by trained technicians.
- Do not attempt to operate the system when the vehicle is in motion.
- Visually confirm that all stabilizer legs are retracted prior to travel.
- The equalizer system is designed to deny extension or retraction if the ignition switch is in the (on) position. If equalizer system is extended and the ignition is turned on it will default and retract automatically.
- Make sure there are no obstructions in the path of the extend or retract paths of the stabilizer unit.
- Do not use the stabilizer legs to lift the unit to perform any kind of service work or to change the legs. The system is designed to stabilize the unit not to lift it off the ground.
- Do not go under vehicle while stabilizer legs are extended.
- Do not operate any system functions while anyone is under the coach.
- Do not allow excessive motion in the coach during stabilizer operation. This could cause the system to stabilize improperly.
- Modification of any factory-supplied item may result in denial of all warranty claims.

PARKING THE COACH

- Care must be taken when selecting a parking spot. Since the system is designed to provide stabilization, rather than leveling, park the coach on suitably level ground. The surface must be firm enough to prevent the stabilizer feet from sinking into the ground.
- Place the transmission in PARK and set the PARKING BRAKE.
- Prior to ANY system operation, visually confirm that the area above and below the stabilizers is clear of objects or obstructions.
- In order for the slide out(s) and/or stabilizers to extend/retract, turn the ignition key to the ON position. Deploy the stabilizers before extending Slide-Outs. Retract Slide-Outs and stabilizers will retract automatically when the ignition key is turned to the ON position.

EQUALIZER SYSTEM

EQUALIZER POWER FUSE BLOCK

- The Equalizer system has a 40amp fuse block located on the battery distribution center in the coach battery compartment. See Figure 10-1

Figure 10-1: Equalizer Fuse Block



EQUALIZER SYSTEM CONTROLLER

- The Equalizer controller is located on the passage side first cargo bay. This unit is self-contained and senses current from each stabilizer as they are deployed and retracted. compartment. See figure 10-2

Figure 10-2: Equalizer Fuse Block

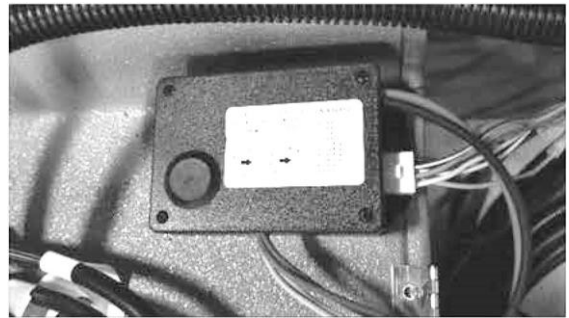

EQUALIZER SYSTEM CONTROL SWITCH

- The Equalizer control switch is located on driver side in the front cab, under the Mercedes gear leaver. This switch will allow the operation of the equalizer system. See below instructions on switch operation. See figure 10-3

Figure 10-3: Equalizer Control Switch



EQUALIZER SYSTEM

EXTENDING THE STABILIZERS

1. Enable the System: Move the ON/OFF switch to the ON position. Depending on the installation, a safety interconnect circuit may be present. Certain conditions may have to be met in order to operate the system. For example, this circuit may require the ignition be OFF, the parking brake set, or the slide-outs fully retracted in order to operate the system.
2. Extending the Stabilizers: Push and release the EXTEND button. This starts the automatic stabilizing cycle. The stabilizers will automatically extend until they contact the ground, slightly lifting the coach. The red EXTENDED LED light will illuminate to indicate the stabilizers are out of the stowed position. To interrupt the Auto Stabilizing Cycle: Push and release the EXTEND button once. This will stop the stabilizer movement. Do not turn the ON/OFF switch OFF.
3. Disable the System: Once the stabilizers have firmly contacted the ground and the system has completed stabilizing, move the ON/OFF switch to the OFF position.

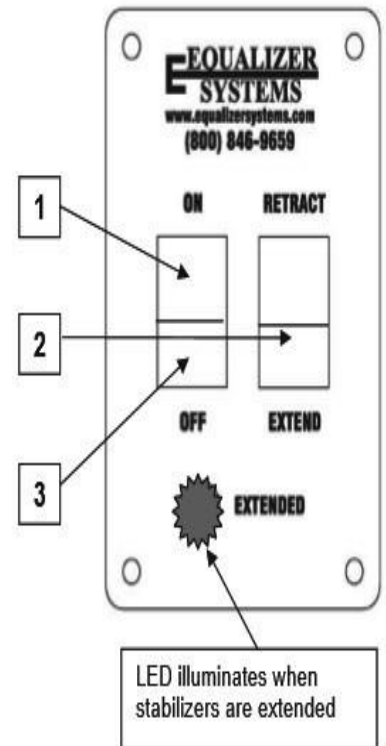

RETRACTING THE STABILIZERS

1. Enable the System: Move the ON/OFF switch to the ON position.
2. Retract the Stabilizers: Push and release the RETRACT button. This starts the automatic retraction cycle. The stabilizers will automatically retract to the stowed position. The red EXTENDED LED light will go out to indicate the stabilizers are fully retracted. To interrupt the auto retraction cycle: Push and release the RETRACT button once. This will stop the stabilizer movement. Do not turn the ON/OFF switch OFF.
3. Disable the System: Once the stabilizers have fully retracted and the system has automatically stopped running, move the ON/OFF switch to the OFF position.
4. Inspect: Visually confirm that the stabilizers are fully retracted into the stowed position and ready for travel.

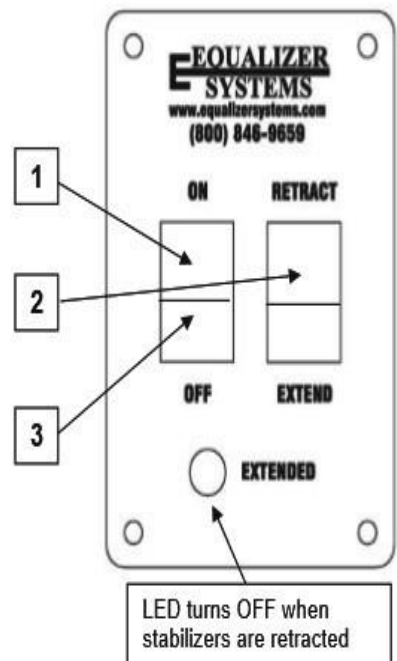

EQUALIZER SYSTEM

NOTICE

The equalizer system is designed to deny extension if the ignition switch is in the (on) position. If equalizer system is extended and the ignition is turned on it will default and retract automatically. DO NOT TRY TO OPERATE STABILIZER SWITCH WITH IGNITION ON.

EQUALIZER SYSTEM

WAY FARE R

SLIDE-OUT FEATURES

Chapter

11

GENERAL CONSIDERATIONS

The Wayfarer is equipped with a slide out located on the drivers' side and on the rear of the motorhome. The slide-out-room feature is actuated by a wall switch (Figure 10-1). Press the slide-out setting to extend or retract the slide-out.

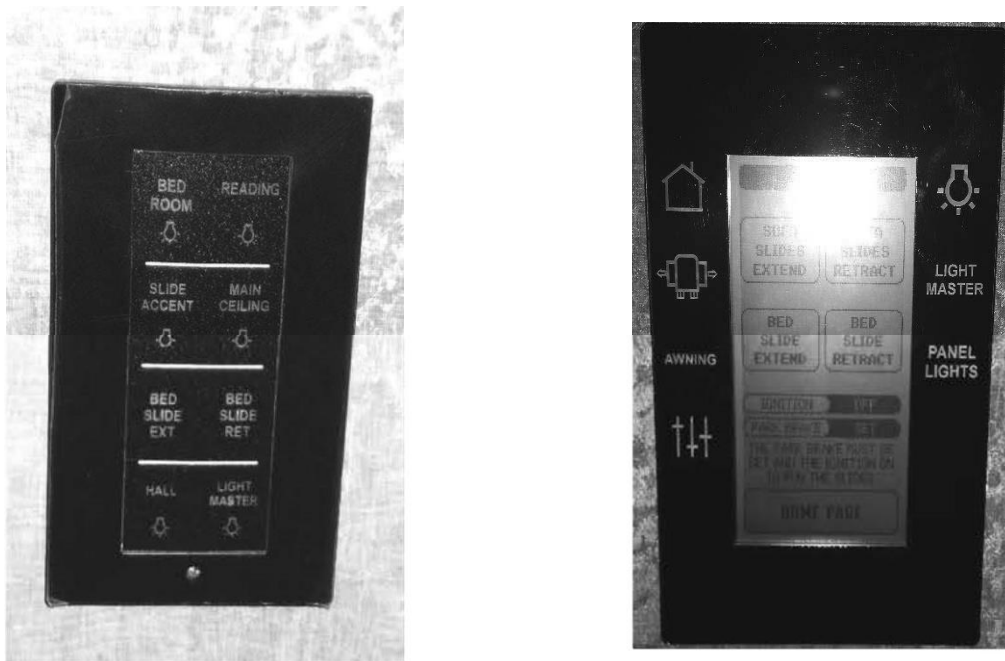

Figure 10-1: Slide-out Switches

OPERATING PRECAUTIONS

Before the slide-out-room mechanism is to be used, make sure the motorhome is parked level. Verify that no obstacles (e.g., branches, trees, telephone poles, power/water hookups, trash bins, etc.) are within a five-foot space envelope of that slide-out room to keep from damaging the slide-out room when it is finally deployed.



Figure 10-2: Typical Slide-out fully extended.

EXTENDING THE SLIDE-OUT ROOM

1. Any loose materials or possible obstructions, such as rugs or furniture should be removed from the immediate, slide-out room area. Make sure that the motorhome has been leveled, that the battery is fully charged and connected to the electrical system, parking brake must be set and that the ignition switch is “on” and the engine is running before attempting to use the slide-out features.
2. Verify that there are no obstructions outside which may interfere with the operation of the slide-out room.
3. Make sure the ignition switch is on the “on” position and the parking brake is engaged.
4. Push the “Extend” portion of switch and allow the slide-out room to go to its fully extended position. When fully extended, release the switch.

NOTICE

Before attempting to extend the slide-out room, check to make sure that there is at least five foot clearance around the area where the slide-out will be extended. Do not allow anyone to sit in slide out while operating the slide feature. This could result in extensive damage to the motorhome.

NOTICE

If the slide-out room doesn't move when the switch is depressed, check the following:

- Make sure the ignition system is turned “on.”
- Make sure the park brake is engaged.
- Make sure the battery is fully charged and connected.
- Make sure the slide-out breakers haven't been “tripped.”
These are located in the storage box with the inverter or converter.

RETRACTING THE SLIDE-OUT ROOM

1. Before attempting to move the motorhome, the slide-out room must be fully retracted.
2. Verify that the 12 VDC system is fully charged and connected to the electrical system.
3. Make sure all personal equipment and any children are away from the slide-out.
4. Make sure all cabinet doors around the slide-out areas are closed.
5. Push the retract section of the touch panel; allow the slide-out room to go to its fully retracted position.
6. Release the rocker switch (this locks the room into position).
7. For the slide-out in the bedroom the bed must be raised to retract.

WAY FAREER

EXTERIOR FEATURES

Chapter

12

TOWING HITCH

On the rear of the Wayfarer is a Class 2, 5,000-pound towing hitch (Figure 11-1) capable of handling a tongue weight of 500 pounds.

This hitch is installed for towing a passenger car to be used when the vehicle is parked.

The wire connector installed with this hitch is a standard, seven-pin connector.



FIGURE:11-2 EXTERIOR OF WAYFARER

The sides (Figure 11-2) of your Wayfarer are constructed of gel-coated fiberglass.

To add to this feature, the end caps are also gel-coated fiberglass. To clean these fiberglass surfaces, only use warm water and a mild cleanser; gently wash with soft cloths. Use of stiff bristle brushes or other harsh abrasives may cause scratches in the fiberglass surfaces.

Please note: Tiffin Motorhomes is NOT responsible for the weathering and/or oxidation of gel-coated surfaces.

Spacious storage compartments are located on the exterior sides of your Wayfarer. These external compartments provide ample, additional space for your belongings while you are traveling. When stowing materials in these storage compartments, try to “balance” the resultant weight load from front to rear and from side to side—this will keep the center of gravity of the motor home essentially unchanged and should not adversely affect the handling characteristics of the motor home when it is in motion.

SECURITY LIGHTS

On the Wayfarer, exterior security lights (Figure 11-3) are standard features.

A light is installed on the passenger side of the coach to help light that side of the Wayfarer for added protection.

This light can serve as a “porch light” when the motorhome is parked and the awning is deployed so that various activities (e.g., sitting outside, grilling, visiting) at dusk and later can be enjoyed by the motorhome owners and their guests.

Security Light

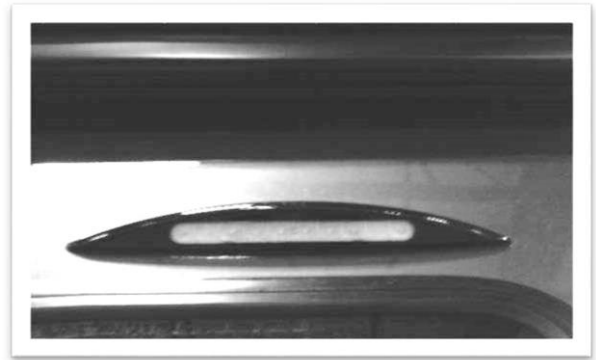

Figure 11-3: Exterior

ELECTRIC STEPS

Figure 11-4: Electric Steps

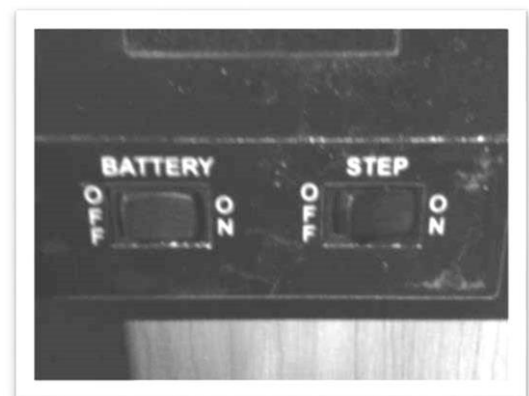

Figure 11-5: Step
Switch

The Wayfarer is equipped with electric door steps (Figure 11-4).

The switch (Figure 11-5) to operate these steps is located in the door stairwell. When the power switch for the steps is in the “on” position, simply open the door and the steps will automatically extend.

Detailed operation for the electrical, double-entrance, door steps is as follows:

1. Turn the step power switch “on”.
2. Close the door. The step should retract and lock into the UP position.
3. Open the door. The step should extend and lock into the DOWN position.
4. Turn the step power switch “off.” The step should remain in an extended position when the door is closed. Turning “off” the power with the step retracted will hold the step in a retracted position, as well.

5. With the step extended, turn the step power switch “off” and close the entrance door. Turn the vehicle ignition switch “on.” The ignition override system will go into effect and the step will automatically retract.
6. With the step switch in the “on” position, turn the vehicle ignition switch “off” and open the door. The step will extend and lock in the DOWN position.
7. This feature is only operative the first time the door is opened after the vehicle ignition switch is turned “off.” When the ignition switch is “on,” the step will always activate with the door movement, regardless of the position of the step power switch.

Other exterior features include power-assisted patio awning. If such are available, they can be controlled from the switch console located in the stairwell of the Wayfarer (see Figure 9-8).

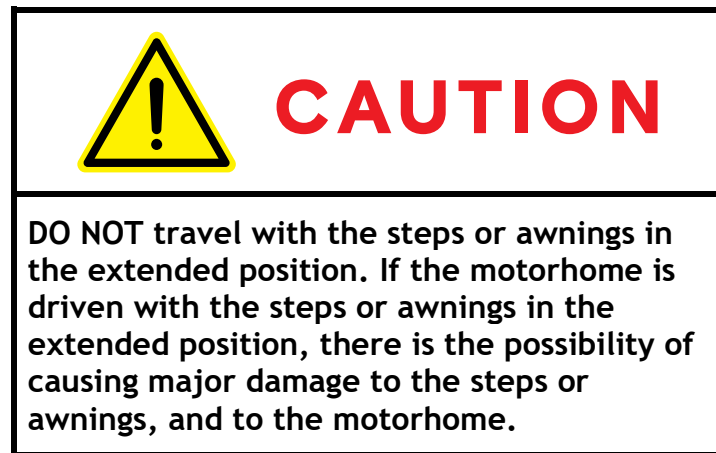

Move the control in the direction of movement desired to obtain the best view for that mirror. The

NOTICE

If the door is opened and closed without allowing the step to extend fully and lock in the DOWN position, the step will retract and lock in the UP position. When the door is re-opened, the step will not extend. The power switch must be turned ON for the step to extend.



adjustment control moves the top half of both mirrors. The bottom half of each mirror is convex and is adjusted manually.

Further information can be found in the Mercedes Owner's Manual.

Detailed instructions for these manual adjustments

This motorhome is equipped with remote controlled, exterior, rear-view mirrors (Figure

Always adjust the mirrors for maximum rear visibility prior to driving. If another driver is to drive, be sure the mirrors are readjusted to accommodate the second driver.

The mirrors are adjusted by using the multidirectional switch located on the dashboard. Select the mirror to be adjusted by pointing the arrow in the direction of that mirror.

can be found in the manufacturer's literature available in the Owner's Information Package.

However, this brief overview of mirror adjustment can begin the process: The top portion of the mirror should be adjusted horizontally so that you can see your own motorhome in the one-inch surface closest to the motorhome. The remaining portion of the mirror now permits you to see the road behind you. The mirror should be adjusted vertically so that you can see the rear bumper on the bottom of the plane portion of the mirror.

The convex mirrors should be adjusted horizontally so that you can see your own motorhome in 1/3 of the mirror. These convex mirrors should then be adjusted vertically to allow you to see any other vehicles alongside your motor home.



CAUTION

Always be sure to "look before you leap!" When opening the entrance door from the inside, be sure that the step has fully deployed before trying to step outside to avoid falling and possible injury.



WAY FAREER

INTERIOR FEATURES

Chapter

13

FLOORING

Vinyl flooring (Figure 12-2) is standard throughout the motorhome with the exception of the slide-out rooms, which are carpeted. For routine cleaning, sweeping or vacuuming the floor would be sufficient. If more thorough cleaning is warranted, the flooring can be cleaned with a damp mop and water. For stubborn stains, a mixture of soap free household cleaner (e.g., vinegar, ammonia, or comparable products) and water can be used to advantage.



FLOORING IN THE WAYFARER

You should not saturate the floor surfaces with water, as this could damage the flooring substrate. Do not use any abrasives (cleansers, scouring pads; and the like) as they can scratch or mar the vinyl flooring surfaces and may cause damage to the vinyl flooring.

CEILING

The ceiling in the Wayfarer motorhome is covered with a padded-vinyl headliner which can be easily cleaned with a damp, soft cloth and a mild detergent.

Clean around all vent areas to prevent any buildup of dirt, grease, or other accumulations.

WINDOW TREATMENTS

Throughout the Wayfarer, the window treatments consist of a blackout shade.

This blackout shade keeps heat and sunlight out during the day and provides complete privacy at night.

Each shade can be raised and lowered simply by pulling down on the shade.

The blackout shades are located on all the windows in the living area and bedroom. The cab over the bunk has a manual roller shade.



CAUTION: DO NOT overextend the shade; this will damage the roller tube. To operate the cockpit shades, pull the shade down to the desired level and slowly release to lock the shade in place. To retract, gently pull down on the shade and release.

WAYFARER

PLUMBING & BATH FEATURES

Chapter

14

PLUMBING & BATH FEATURES

MONITOR PANEL

The monitor panel (Figure 13-1) permits checking the approximate levels in the fresh, gray, and black water holding tanks; the LP-gas level; and the condition of the battery.



KITCHEN SINK

For the sink, cleaning care consists of washing only with mild detergents and water and using a soft cloth for subsequent drying and polishing.



SINK, SHOWER & ACCESSORIES

The typical bathroom accessories include a towel bar and a toilet paper holder. The faucet in the bathroom was chosen to match the specified decor. The tub faucet with showerhead, hose, and bracket are coordinated with the sink faucet.



PLUMBING & BATH FEATURES

WATER PUMP

The water pump is self-priming and totally automatic, operating on demand whenever water is required. The water pump is used to pressurize the freshwater system when the unit is not connected to city water.

To start the pump, follow these instructions:

1. Fill or partially fill the fresh water supply tank
2. Open the kitchen and bathroom faucets.
3. Turn the water pump switch “on” and allow the water to fill water line and hot water heater.
4. Close each faucet after it delivers a steady stream of water (close the cold-water faucet first). Leave the hot water faucets “on” until they also deliver a steady stream of water. This procedure will assure that the water heater is filled with water.
5. The water pump should stop running once all faucets are closed.
6. The water pump is now ready for automatic operation. The pump will run when a faucet is open and stop when a faucet is closed.
7. Never allow the pump to run for long periods of time without water being present in the supply tank, as doing so may cause physical damage or blow fuses.



If water does not flow when a faucet is turned “on” while using the demand system, use the following troubleshooting chart:

<u>SITUATION</u>	<u>SOLUTION</u>
Pump running – no water	1. Fill tank
Pump doesn't Run	2. Clear the water line to the pump
	1. Check the pump switch.
	2. Check the 12-volt fuses
	3. Check the electrical connections
	4. Check the Battery

All the water should be drained from the freshwater system when the unit is not in use for extended periods. For more detailed information regarding the water pump, one should refer to the water-pump manufactures brochure.

CITY WATER CONNECTIONS

When connecting your unit to city water, use the water hose manufactured and labeled for potable water service—this will assure that the hose selected for use will not alter the taste of the water.

When connecting your unit to city water, use the water hose and connect to **#1** in the above figure. While doing so, make sure the blue handle is turned to CITY.

PLUMBING & BATH FEATURES

HOOKUP

To connect the city water supply, connect one end of the hose to the city water supply.

Turn the city water supply “on” for a few seconds to clear the line. Once the hose has been flushed, turn the supply “off.” Connect the other end of the hose to the inlet valve on the sewer board; turn the blue handle valve on the sewer board to the city water fixtures turn the red handle valve on the sewer board to normal. (Note: As the water goes through the inlet and then passes through the filter insuring that all water exiting the faucets and showers have been filtered). Once the city water fill valve is opened, water is supplied to the freshwater system including the hot water heater, faucets, and toilet. Turn “on” the water supply and open all of the faucets to clear any trapped air within the plumbing lines within the motor home.



Once any air pockets have purged from the water lines and water flows freely, close all the faucets. The city water supply is pressurized; therefore, the water pump is not needed when the water system of the vehicle is connected to the city water system.

The valves should never be turned while there is pressure on the lines.

The freshwater tank is normally filled from the city water inlet on the sewer board. The red and blue handle valves located on the sewer board determine whether the city water is going through the water system or into the freshwater tank. To fill the freshwater tank, turn the blue handle valve to city fill tank, turn the red handle valve to normal. Since there is no automatic shut-off when filling the freshwater tank, check the level from the monitor panel while filling the freshwater tank on the motorhome. (NOTE: As your freshwater tank fills the water passes through the filter insuring that the water in the freshwater tank has been filtered before use).

All of the water should be drained from the freshwater system when the motorhome is not in use for an extended period of time.

RUN HOT AND COLD FIXTURES FROM FRESH WATER TANK

After filling the freshwater you are ready to run the water system from the freshwater tank supply.

1. Turn “on” water pump.
2. On the sewer board turn the blue handle valve to the normal position and turn the red handle valve to the normal position.

SANITIZING HOT AND COLD FIXTURES AND FRESHWATER TANK

To assure complete disinfecting of the freshwater system, it is recommended that the following procedures be performed on a new system, on one that has not been used for a length of time, or one that may have become

PLUMBING & BATH FEATURES

contaminated. This procedure is also recommended before long periods of storage, such as during the winter months:

1. Drain the freshwater tank by opening the drain valve. All of the faucets should be in the closed or “off” position.
2. Prepare a chlorine solution using one gallon of water and one-half cup of chlorine bleach (5% sodium-hypochlorite solution). Prepare enough of the chlorine solution to administer one gallon of solution for every 15 gallons of tank capacity. Concentrations greater than 50 ppm may damage the water lines and/or the tank.
3. Once the freshwater tank is empty, close the drain valves in the water tank.
4. Pour the solution in the gravity fill which is located on the rear of this coach.
5. Turn “on” the water pump. On the sewer board turn the blue handle valve to “normal” position and turn the red handle valve to “normal” position.
6. Open each faucet, in turning “on” both the hot and cold faucets and flushing the toilet until all of the air has been purged from the pipes and the water runs freely. The entire system will then be filled with the sanitizing solution.
7. Allow the 50 ppm disinfecting solution to stand in the system at least four hours.
8. Drain the system and flush it with freshwater. The water system needs to be flushed with water repeatedly, if necessary, until there is no chlorine taste or smell left in the system. To remove any excessive chlorine taste or odor that might remain, prepare a solution of one quart of vinegar to five gallons of water. “Rock” the tank containing the solution; by moving the vehicle forward and backward several times to clean the tank; then drain that tank and refill with clean water.

SANITIZING HOT AND COLD FIXTURES ONLY (NOT FRESHWATER TANK)

1. All faucets should be in the closed or “off” position.
2. Prepare a chlorine solution using one gallon of water and one-half cup of chlorine bleach (5% sodium-hypochlorite solution). Concentrations greater than 50 ppm may damage the water lines.
3. Connect one end of the vinyl hose to the inlet valve on the sewer board; place the other end of the hose into the solution that has been prepared.
4. Turn “on” the water pump. On the sewer board turn the blue handle valve sanitize/winterize and turn the red handle valve to bypass.
5. Open each faucet, in turning “on” both the hot and cold faucets and flushing the toilet until all of the air has been purged from the pipes and the water runs freely. The entire water lines will then be filled with the sanitizing solution.
6. When the sanitizing process is completed, turn the water pump “off”.
7. Allow the 50 ppm disinfecting solution to stand in the system at least four hours.
8. Drain the system and flush it with freshwater. The water lines will need to be flushed with water repeatedly, if necessary, until there is no chlorine taste or smell left in the system. To remove any excessive chlorine taste or odor that might remain, prepare a solution on one

PLUMBING & BATH FEATURES

quart of vinegar to five gallons of water. Repeat steps four, five and six to run the solution through the water lines. Drain the system and flush with freshwater.

WATER FILTER

This unit is equipped with a water filter (Figure13-7) which must be removed before disinfecting the fresh-water system.

First remove the water filter and then replace cover to allow the sanitizing solution access to the faucets. As installed, the filter will remove chlorine, dirt, and other matter. The filter will also eliminate most phenol (or similar) odors and tastes while delivering sparkling, taste-free water for drinking and cooking.

The water filter is located in the sanitation compartment on the outside of the motorhome. The water filter is not guaranteed to

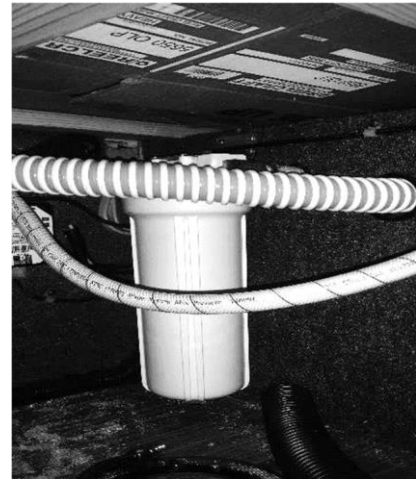

Figure 13-7: Water Filter

remove the tastes and odors of iron and sulfur. To remove these impurities, you need to chlorinate the water. Replacement filters are available that will filter iron and sulfur. Ask your dealer or RV supply center about purchasing an iron and sulfur filter.

If you are traveling in an area where the water has high iron and sulfur content, then add one tablespoon of chlorine bleach to every 10 gallons of water in your tank—this will precipitate the iron or sulfur so that the filter can remove those impurities.

If you are at a site where the unit is connected to a city water supply, you will not be able to chlorinate the system because the water flows straight to your faucets and not through the freshwater tank.

Filters should be changed every 6-12 months depending on the quality and quantity of water that is used in your motorhome.

WATER HEATER BYPASS SYSTEM

This process is performed when winterizing your motorhome. Using the bypass valve will keep antifreeze out of the water heater when winterizing the motorhome. Draining the water heater during winterizing is a MUST.

BYPASS WATER HEATER FOR MAINTENANCE

This procedure is used for any maintenance that may be done to the water heater. On the sewer board turn the blue handle valve to the city fixture position and turn the red handle valve to the bypass position. (NOTE: You will still be able to use your faucets and showers if necessary but it can only be done with pressurized city water and will only receive cold water).



Figure 13-8: Water Bypass

PLUMBING & BATH FEATURES

FRESHWATER LINES

Check all of the plumbing connections for leaks at least on an annual basis.

If the water pump runs when all faucets are turned “off,” check for a possible leak. Be sure that the drain valves are closed. Connections at the kitchen and bathroom faucets normally seal by hand-tightening them and then making an additional half-turn with a wrench.

If a fitting leak persists, disconnect it completely and visually inspect it for mineral deposits or foreign material stuck on the sealing surfaces. Clean the surfaces thoroughly and reinstall the fitting.

GENERAL INFORMATION

The waste drainage system was designed to provide adequate and safe storage and/or disposal of waste materials. All of the materials used in the fabrication of this system are tested by a nationally recognized testing laboratory. The drainage system uses plastic piping and fittings connected to the sinks, toilet, and holding tanks. This plumbing permits the drainage of these fixtures to an outside termination. The vehicle should be reasonably level for best operation of both of the wastewater systems.

There are two, separate wastewater systems. The gray-water system is for wastewater from the sinks and shower. The black-water system is for sewage waste from the toilet. Each wastewater tank has its own control valve and both drain through a common sewer-drain hose.

TOILET

The toilet (Figure 13-9) operates with water from either the fresh water tank with the water pump “on” or the city water supply. Before using the toilet, add water to the bottom of the tank. Refer to the “BLACK WATER TANK” instructions.

The toilet flushes waste directly into the black-water holding tank. It is imperative that you use as much water as possible when flushing to prevent tissue and other solids from clogging the holding tank outlet.

When using your toilet, fill the toilet $\frac{3}{4}$ full of water. To add water to the toilet bowl, push the pedal lever $\frac{1}{4}$ of the way down until the desired water level is reached. To flush the toilet, push down on the lever until the water swirls. A small amount of water should remain in the bowl.

The toilet should be cleaned regularly for maximum sanitation and operational efficiency. Clean the toilet bowl with a mild bathroom cleaner.



PLUMBING & BATH FEATURES

NOTICE

Do not use chlorine or caustic chemicals, such as bleach or drain opening chemicals in your motorhome's toilet. This will damage the seals in the toilet and dump valves.

BLACK WATER HOLDING TANK

The "black water" (i.e., sewage) holding tank is located directly beneath the toilet. Before using the toilet, you will need to treat the tank with water that is mixed with an odor-controlling chemical. These chemicals are readily available at any RV supply store. Pull the toilet levers forward to allow the chemicals to mix with the toilet water. Continue pulling the toilet levers until a depth of at least one inch of solution is directly under the toilet. Release the levers and the waste tank is now ready for use.

GRAY WATER HOLDING TANK

The gray-water holding tank is located in the underbelly of the vehicle. It is primarily used for the drainage from the kitchen and bath sinks and the shower. P-TRAPS Each of the sink drains and the shower drain has a water trap (P-trap) to prevent holding-tank odors from entering the vehicle. These traps must have water in them to trap odors. When the vehicle is in motion, the water may splash out of the sink and shower drains. When the vehicle is stored, the water may evaporate from these traps allowing odors to enter the vehicle. If this occurs, run water from the faucet into the drain, allowing water to fill the traps again.

NOTICE

Use only RV odor-controlling chemicals in the holding tanks. Products containing ammonia and petroleum will damage the ABS plastic holding tanks and seals.

WASTEWATER DISPOSAL

Both of the holding tanks terminate in a valve arrangement that permits draining each tank separately or together. It is recommended to drain the black water tank first before draining the gray water tank. This procedure permits the water from the gray tank to wash the black-water residue from the drain lines.

PLUMBING & BATH FEATURES

The valves that open to release the water are called gate valves. The blade that closed the opening in the sewer drainpipes is connected to the T-handle to release contents of the tank(s) when pulled. The sewer line must be securely capped during self-containment use to prevent leakage of waste materials. Do not pull the holding tank gate valve “open” when the protective cap is installed on the pipe.

Always drain the tank into an acceptable sewer inlet or dump station. Whenever possible, drain both the holding tanks prior to traveling. The carrying capacity of your vehicle will be reduced if water is left in the black or gray tanks. The holding tanks should only be drained when they are at least $\frac{3}{4}$ full. Doing this will provide a sufficient volume of water to allow the complete flushing of waste materials in the drain lines and hose. If the tanks are not $\frac{3}{4}$ full, add enough water to allow for sufficient flushing.

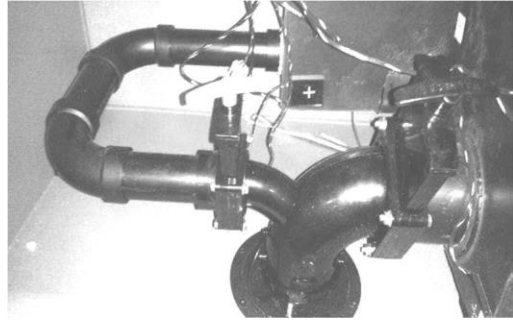

To empty the wastewater tanks, connect the adapter, supplied with your vehicle, to the drain hose. Unscrew the cap from the drain. Connect the hose, with the adapter in place, to the drain fitting. Open the gate valve completely by pulling on the T-handle. The tank will start to drain as soon as the T-handle is pulled. After you have drained the black-water tank, immediately drain the gray-water tank. This procedure helps to flush the black water from the sewage hose. When both the tanks are empty, flush them with a freshwater rinse before you close the valves. The gray tanks are easily flushed by pouring a couple of gallons of water into a sink drain. The drain outlet is engineered for quick release of the drain hose adapter. Always close the gate valves and secure the end cap to prevent leakage while the vehicle is in transit.

After draining the black water tank, it is recommended to add a holding tank deodorant to help control the odor and break down the solids. Follow the instructions given on the holding tank deodorant package.

SEWER CONNECTION AND CAMPING

While using the motorhome, it is important to keep the black-water holding-tank gate valve closed at all times, except when dumping. This allows an ample amount of liquid to remain in the tank to provide a smooth flow through the gate and drain valves when dumping. Sufficient liquid in the tank causes a swirling action that should take any accumulated solid wastes with it. Accumulation of solid wastes in the black water tank can be avoided by keeping the gate valve closed when connected to the sewer connection. The gray tank can be kept open while hooked to a sewer connection.

NOTE: When dumping, it is suggested to dump the black tank first, then the gray.

NO FUSS FLUSH

This vehicle may be equipped with a flushing system for the black-water holding tank. When draining your sewer tank, attach a water hose to the sewer spray connection. After the tank is drained, leave the gate valve “open” and open the water valve to allow water to spray inside the black-water tank. This will clean the inside

PLUMBING & BATH FEATURES

of the tank of any debris that may be left inside the tank. After this procedure is done, disconnect the freshwater hose and close the gate valve.

NOTICE

Be sure the gate valve is OPEN when flushing the tank. Do not use the same hose that for filling the fresh water tank for the No Fuss Flush.

Be sure the gate valve is “open” when flushing the tank. Do not use the same hose for the No Fuss Flush that is used for filling the fresh water tank.

EXTERIOR SHOWER

Your Wayfarer has an exterior shower for your use and convenience outside the motorhome. The exterior shower is located in the service compartment on the driver’s side and allows you to do such things as rinse off sand or grass, muddy shoes, or bathe yourself outside of your motorhome.

The faucet operates just as it would in your kitchen or bathroom. Exterior Shower and light.

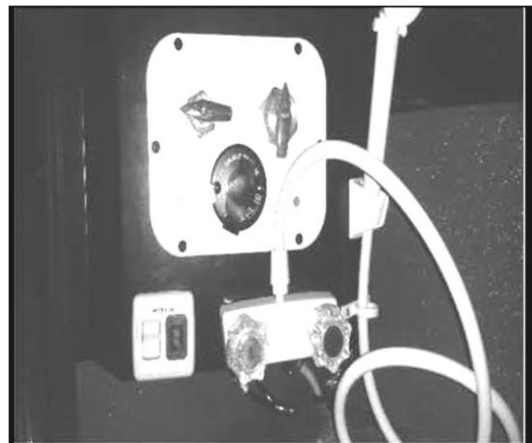

PLUMBING & BATH FEATURES

PLUMBING DIAGRAM

25JW

Water Lines

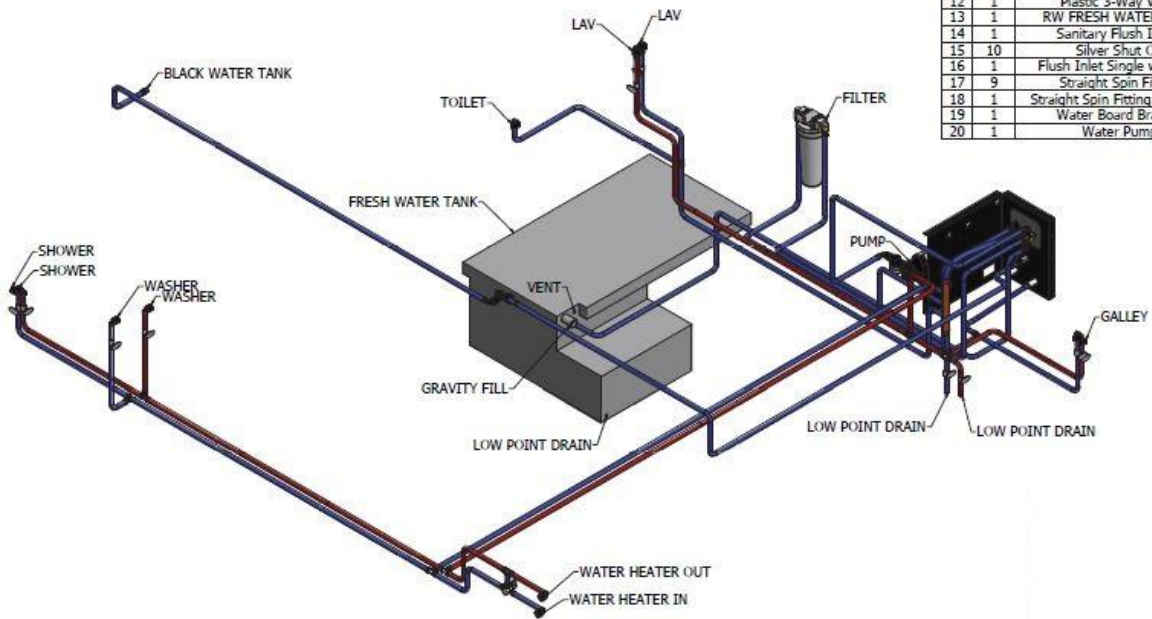

PARTS LIST			
ITEM	QTY	DESCRIPTION	PART NUMBER
1	1	1/4 Turn Panel Mount	5089084
2	1	3 Port manifold	3 Port Manifold
3	12	90 Degree Spin Fitting	8959
4	1	90 Degree Spin Fitting PEX	5101557
5	61	Crimp Ring	5003777
6	1	Filter Bracket	2503
7	2	Filter Brass 90	5061095
8	1	Filter Housing	2502 / 38545 / 2504
9	1	In Line Pump Filter	18313
10	1	OutDoor Faucet	5053034 / 5053033
11	10	PeX Tee 1/2"	5018946
12	1	Plastic 3-Way Valve	5086033
13	1	RW FRESH WATER TANK	5105363
14	1	Sanitary Flush Insert	5064297
15	10	Silver Shut Off	5018959
16	1	Flush Inlet Single with Cap	5064297
17	9	Straight Spin Fitting	5018957
18	1	Straight Spin Fitting PEX 1/2"	5018951
19	1	Water Board Bracket	5086544
20	1	Water Pump	5014479

PLUMBING & BATH FEATURES

Gas Line Assy

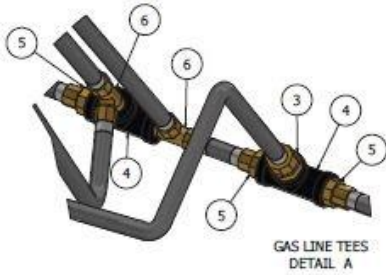

PARTS LIST			
ITEM	QTY	DESCRIPTION	PART NUMBER
1	1	1/2" Male x 1/2" Female Brass Fitting	5064323
2	1	2 Foot 1/2" Flex Line	5068985
3	1	1/2" Male x 1/2" Male Brass Fitting	5056216
4	2	1/2" x 1/2" x 1/2" Tee	5064866
5	4	1/2" Male x 3/8" Male Brass Fitting	5068988
6	2	1/2" x 3/8" x 3/8" Brass Tee	5064302
7	4	4 Foot 3/8" Flex Line	6102
8	1	40" Copper Line	5064840
9	1	Quick Connect Shut Off Valve	5073562
10	1	Quick Connect Line	5073564
11	1	1/4" x 3/8" Reducer	5073563
12	1	6 Foot 3/8" Flex Line	10603
13	2	Nut for Copper Line	5090907
14	1	3 Inch 3/8" Flex Line	-----

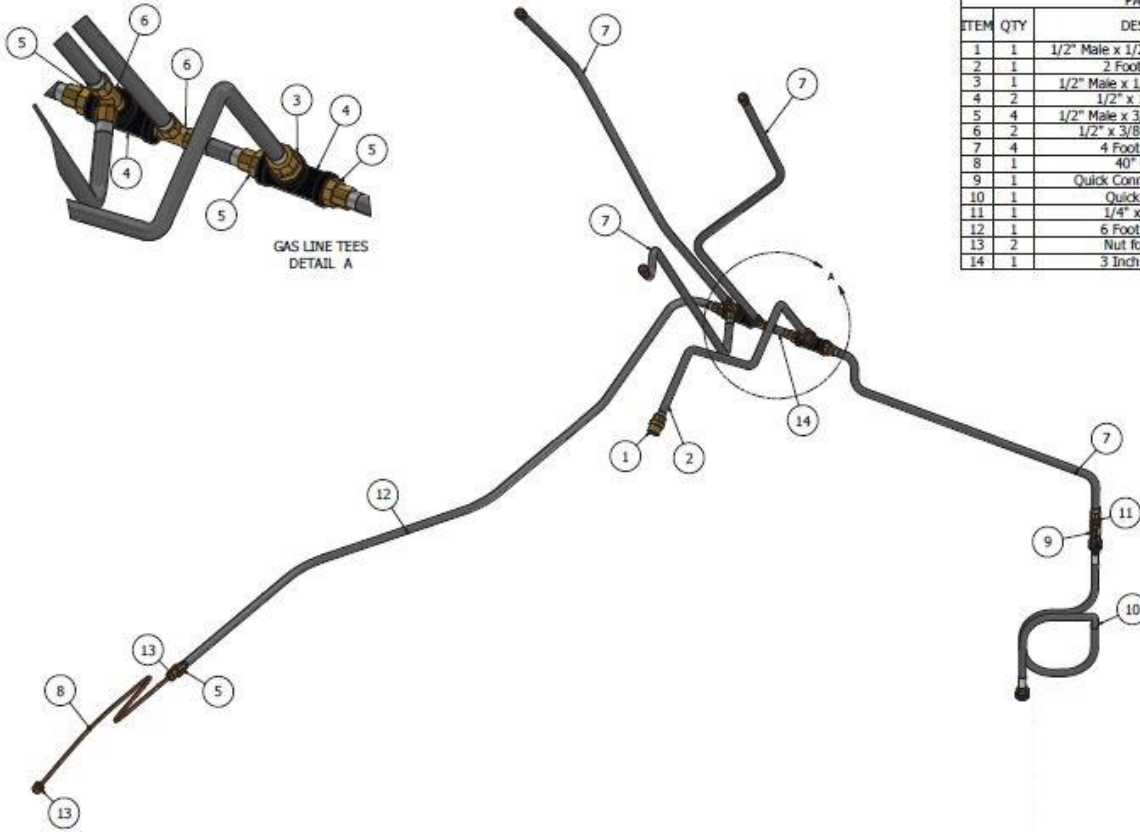

PLUMBING & BATH FEATURES

Drain Line

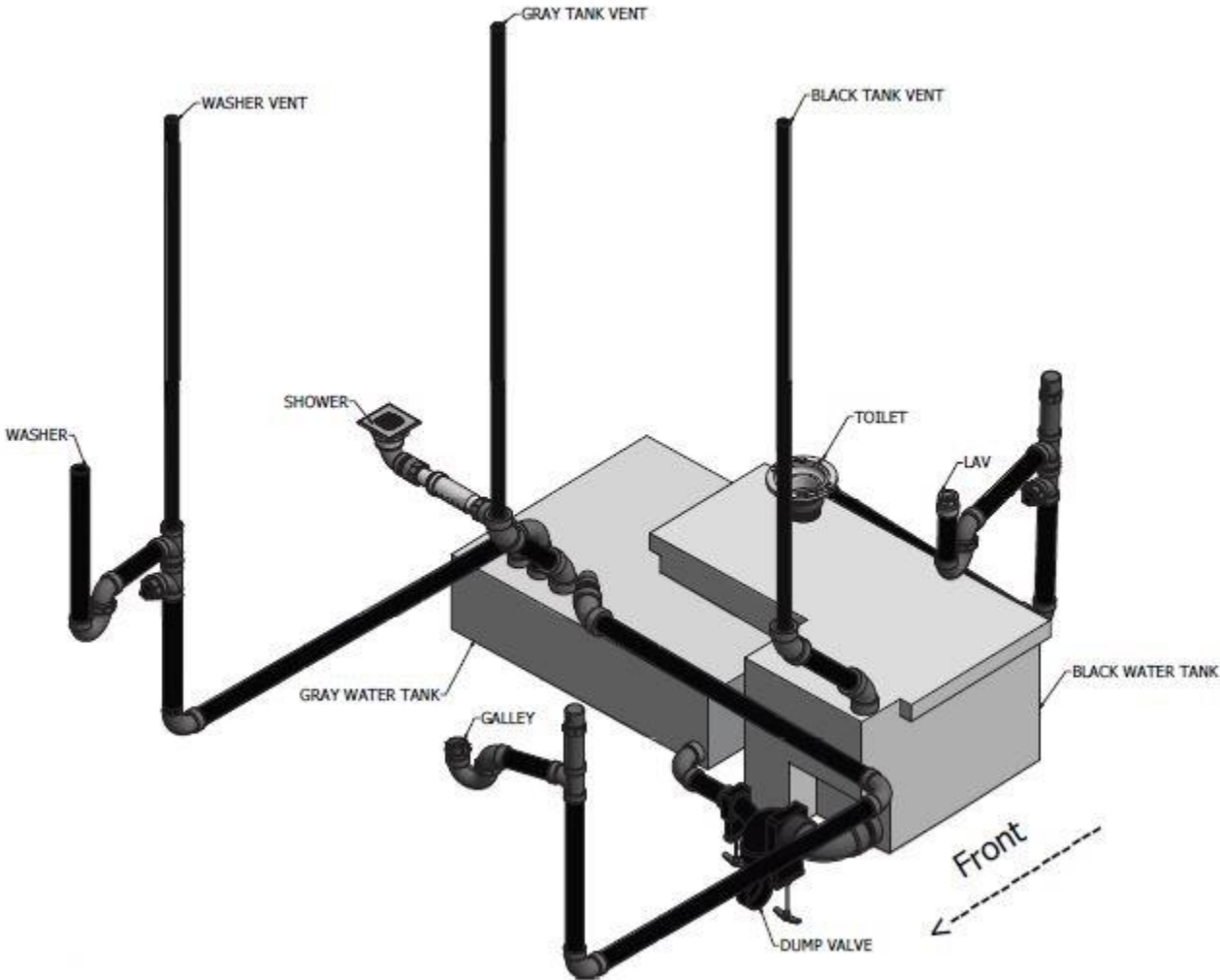

WAY FAREER

WINDOWS, AWNINGS, VENTS, & DOORS

Chapter

15

WINDOWS, AWNINGS, VENTS & DOORS

WINDOWS

Sliding windows are custom built for the Wayfarer and allow easy sliding access to open the coach to fresh outside air.

There may also be a reflective coating on the windows to reflect back a portion of the sunlight to reduce the heating of the motorhome interior and to reduce the effects of the sun's "bleaching" of interior fabrics (curtains, upholstery).

Sun shades on both the driver's and passenger's sides can be deployed and moved at any time.



Figure 14-1: Wayfarer Windows

Windows throughout the coach are designated as "EXIT" windows in the event of an emergency.

To help make the windows slide more easily, we recommend using Plexus Plastic Cleaner which can be purchased through the Tiffin Motorhomes Service Department.

AWNING

The power patio awning (Figure 14-2) is standard on the Wayfarer.

The power patio awning is extremely durable and can be operated during light rain and wind conditions. However, when periods of heavy rain, or wind is expected, or you leave the awning unattended, the awning should be closed. Please note that damage caused by wind and rain is not covered by warranty.

To operate the awning follow the instructions listed below.



Figure 14-2: Power patio awning

To open the awning:

1. Locate the Switch (on the cabinet to your left as you come in the entry door).
 - A. Press the "Extend"/"Retract" button to extend/retract. This button does not have to be held down due to a motion sensor located in the awning.

WINDOWS, AWNINGS, VENTS & DOORS

To close the awning:

NOTE: Pinch Hazard. When closing awning, bottom arm will fold down and against back channel. This area must be kept clear of people and objects. Failure to heed this warning could cause severe personal injury and/or property damage.

1. Locate the Switch.
 1. Press the "Retract" button to automatically close awning. If the button is released the awning will stop. Maintain button depressed until awning is fully retracted, then release.

IMPORTANT: As an extra safety precaution, visually verify that the awning is fully closed.

In case of awning power failure or to manually close awning:

IMPORTANT: This procedure will require two people. When this procedure has been performed, the awning must be serviced by a service center or a qualified service technician before using again.

There are two methods of rolling up the awning if it appears there is no power to the awning motor. The following method should be performed first:

1. When the power awning hardware is in the open position and the 12 VDC power has been lost the awning can be closed by supplying auxiliary power to the hardware. Connect the awning motor to an external 12 VDC power source via user-supplied wire (16 gauge minimum). A good external 12 VDC power source would be an automobile battery.
2. Locate and unplug the motor and hardware cable connection located in the upper part of the right-hand arm.
3. Connect the user-supplied wire leads to the terminals in the connector from the motor. Electrical tape may be required to keep the wire leads in place. (Do not connect to the one in the hardware.
4. Connect the other end to a 12 VDC battery source. The red wire goes to + and the black to -. If there is not a problem with the awning motor, this will retract the awning. To avoid motor damage, disconnect battery source immediately after awning is fully retracted. 5. The awning can be extended by reversing the polarity. Place the red wire on the – and the black wire on the +. Disconnect battery source after awning is fully extended.

If the awning will not retract after performing the steps listed above, perform the following steps.

1. Slide the pull strap (provided) into the utility slot of the FRTA (see awning instructions found in Owner's Information Package).
2. While one person is holding onto the pull strap, remove the screw in the top of the right top casting. The FRTA will immediately roll in once the bolt is removed. Walk the awning to the closed position.
3. Align hole where screw was removed and replace screw into top casting to secure awning.

WINDOWS, AWNINGS, VENTS & DOORS

NOTE: The screw removed from top of right casting has to be reinstalled. This is to prevent awning from opening during travel, personal injury or damage can occur. Have the awning serviced by a Service Center or a qualified service technician before attempting to open awning after this procedure has been performed.



WARNING

Since damage resulting from weather is not under warranty, anytime a heavy or prolonged rain or blustery winds are anticipated, close the awning. Similarly, if the awning is to be left unattended for any prolonged length of time, close the awning.

VENTS

The kitchen, bathroom, and bedroom are all equipped with a 12VDC exhaust vent fan (Figure 143). A three-speed switch controls the fan speed of both. The vent fan should only be left in the “on” mode when the motorhome is parked and in use. The fan will not operate until the vent is open.

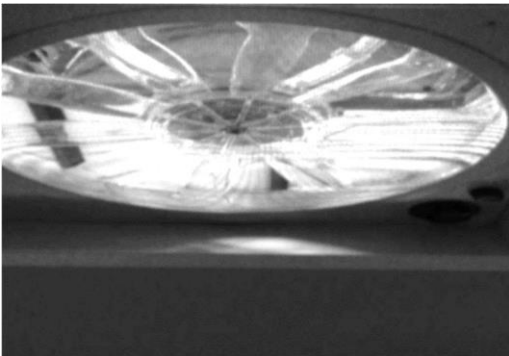

WARNING

Always secure the dead bolt lock while the motorhome is in motion to prevent accidental opening of the entrance door.

DOORS

The primary entrance door to the motorhome has a key lock and a dead bolt for additional security. When the door is fully opened, the door hinge automatically holds the door in an “open” position. There is also a screen that allows increased air circulation when the entrance door is open.

WAY FARE

DRIVING YOUR MOTORHOME

Chapter

16

DRIVING

SINGLE VISION CAMERA MONITOR SYSTEM

The rear-view monitoring system (Figure 15-1) is provided to aid the driver in backing and parking the motorhome.

A camera mounted on the rear of the vehicle feeds a televised view of the rear of the motorhome to the monitor located in the front near the driver. If the mode switch is in the “manual” mode, the monitor will be “on” when the ignition switch is turned “on.”

If the mode switch is in the “automatic” mode, the monitor display the picture from the rear-mounted camera only when the transmission is in “reverse” gear. this system effectively, please the owner’s manual for this This manual is in the Owner’s Information Package.



will
To use
consult
system.

Figure 15-1: Rear-view camera monitor

AM / FM / CD STEREO SYSTEM

An AM/FM/CD stereo system is included in the motorhome. This system is powered by the 12-volt DC system of the motorhome and operates like any conventional car-stereo system. The coach is also SIRIUS XM compatible with a subscription.



Figure 15-2: CD Player

DASHBOARD HEATING / COOLING CONTROLS

The dash air conditioner/heater is not designed to heat and cool the entire interior of the motorhome. It is intended only to provide heating and cooling for the cab area. A small amount of air will blow out of all of the defrost and dash vents regardless of the mode settings.



WAYFARER

ROUTINE MAINTENANCE

Chapter

17

ROUTINE MAINTENANCE

NOTICE

Damage caused by improperly performed maintenance or inadequate maintenance is not covered by your Tiffin Motorhomes limited warranty.

WASHING

The paint on your Tiffin motorhome has a polyurethane base called Diamont. While multiple layers of clear coat sealants protect the paint against oxidation, the sealant must be protected from deterioration (Figure 17-1).

Paint manufacturers advise against using harsh cleaners such as Simple Green, Mr. Clean, or liquid dish washing soaps. The degreasing agents in these cleaners leave a residue on the sealant, which softens and damages the clear coat in time.

Baby shampoo provides an effective yet gentle cleaner. Without the typical heavy degreasers of most detergents, baby shampoo cleans without leaving a residue to gum up the clear coat finish. Generally, one ounce (1 oz.) is all you need per five-gallon bucket of water. Add one cup of food grade distilled white vinegar to your wash bucket.

Tiffin Motorhomes recommends the lamb's wool pad sold by Mary Moppins. This enables you to safely wash your coach from the ground by placing the pad on an extension.

Do not mistake lamb's wool with imitations. Imitation pads are made from 100% polyester, which is plastic. Plastic imitations will scratch the finish of the motorhome. For this same reason, avoid microfiber products to wash or dry your motorhome. Microfiber is made from 80% polyester.



Figure 17-1: Typical Motorhome Exterior



CAUTION

DO NOT use any type of brush or plastic wash materials on the exterior paint as this could cause damage to the finish of your motorhome. Even though you might not see brush marks now, the damage will happen as the bristles wear down.

ROUTINE MAINTENANCE

Use only 100% cotton towels to dry your vehicle. Adding vinegar to your wash water and washing in the morning or evening will help prevent water spots. Water spots damage the exterior of your coach the same way they damage glass shower doors. They etch their way into the surface and removal becomes difficult. Prevention becomes the key.

Wash one side at a time, rinse, and then dry quickly using a squeegee followed by a towel placed over the cleaning head.

To remove oil and grease, remember an important rule of cleaning: give your product time to work. Dab a bit of concentrated cleaner like CleanEz by Mary Moppins—never an orange-based cleaner or one with petroleum distillates—onto a soft cloth. Apply to the oil spot and wait for 10 to 15 minutes before rubbing lightly to remove the oil. Rinse immediately.

SEALS

The seals around the doors, windows, vents, slide-out trim and external seams must be checked at least semi-annually. Additionally, the roof seams must be inspected for cracking or peeling semi-annually. If deterioration is noted during a routine maintenance inspection, reseal the seams or seals with an approved sealant to prevent leaks.

Your Tiffin Motorhomes dealer can perform resealing inspections and subsequent work for you. Tiffin Motorhomes recommends that a Tiffin Motorhomes authorized service center perform these inspections periodically and perform necessary resealing when necessary.

PROPER SEALANTS FOR APPLICATION

The following sealants are recommended for specific sealing applications, as noted in the table. These can be purchased through the Tiffin Motorhomes parts and service department by calling 256-356-0261.

RECOMMENDED SEALANTS FOR SPECIFIC SEALING APPLICATIONS	
SEALANT	APPLICATION
Plas-T-Code	Metal or fiberglass roof
Surebond #SB-140	Rubber laminated to metal roof and ALL SKYLIGHTS
Carlisle #502-LSW self leveling sealant	Rubber roof over wood base
Silicone sealant	To cover butyl and other sealants; not to be used as the main sealant
Parbond	To seal across tops of windows on exterior surfaces where silicone is not used

ROUTINE MAINTENANCE

NOTICE

Do not use solvents such as acetone, MEK, toluene, and the like on the decals. Any solvent including alcohol might soften and smear colors. Do not use lacquer thinner or paint thinner on decals. Do not overcoat the decals with clear paint. Do not allow gasoline or other fuels to come into prolonged contact with the decals. However, if this should occur, immediately flush the affected area with water.

WHEEL CARE

The care and maintenance of your wheels are simple and require no special material or products; follow the directions included in the Owner's Information Package for these. Timely care and cleaning will maintain the appearance of these wheel products for many years.

Be sure to completely wash the aluminium wheels free of all road treatment salt or other chemicals, paying close attention to the area behind the decorative lug nut covers.

**CAUTION**

Do not use harsh detergents, acids, or abrasives, which might scratch or dull the surfaces. The applicator cloth, sponge, or soft-bristled brush must be non-metallic and non-abrasive. Also, remember to check the tightness of the wheel lug nuts frequently.

ROOF CARE & MAINTENANCE

Proper care and maintenance of your motorhome, including your roof, is important for sustained, trouble-free performance. Normal maintenance is simple and easy and does not require special materials.

The roof of the motorhome is fiberglass and can be cared for in the conventional manner. Clean the roof at least every three months. The roof must be professionally inspected by a dealer annually.

ROUTINE MAINTENANCE



MOISTURE MANAGEMENT

This section outlines important recommendations to manage moisture in your motorhome to avoid moisture-related damage, such as mold. The materials and methods used to construct your motorhome were selected in part to minimize air leakage and to create a weather-tight exterior shell. However, in order to protect your investment, and reduce the risk of moisture-related damage and costly repairs, attention and care has to be taken to manage moisture inside your RV.

NOTE: These are only suggestions intended to minimize moisture-related issues with your motorhome. If any concerns arise, contact Tiffin Motorhomes' Service Department at (256) 356-0261.

INTERIOR CARE OF YOUR RV

Signs of excessive moisture can be obvious, such as water droplets forming on surfaces or wet carpet. Conversely, signs of excess moisture can be subtle, such as condensation forming on metal surfaces. When symptoms appear, it is important to immediately determine the cause of the excess moisture and take appropriate corrective action to prevent moisture-related damage.

CONTROL RELATIVE HUMIDITY

Monitoring and controlling relative humidity within the motorhome is one of the most important steps to minimize the risk for moisture-related damage. Ideally, relative humidity should be at 60% or less. Relative humidity can be monitored utilizing a portable hygrometer, which is a small device that measures temperature and relative humidity.

Use exhaust fans, the air conditioner, and/or a portable dehumidifier to manage moisture inside the RV to maintain relative humidity at 60% or less. In cold climates, relative humidity might need to be at 35% or less to avoid window condensation issues. If the motorhome is used, the majority of the time in a hot, humid climate, it might be difficult to keep relative humidity below 60%. A dehumidifier will help, but check the condensation (water) collection bucket regularly or discharge the condensation (water) directly to a drain.

ROUTINE MAINTENANCE

AVOID DRASTIC THERMOSTAT SETBACKS

To minimize the opportunity for condensation to form on interior surfaces, maintain a comfortable temperature in your RV, and avoid night-time setbacks of 10 degrees or more. Drastic setbacks that reduce the indoor air temperature quickly can increase the chance for airborne moisture to condense on cool surfaces such as windows. If you are away from your RV for an extended number of days, do not set the temperature back without taking other measures to manage relative humidity, including operating a dehumidifier with a continuous drain.

MANAGE WINDOW CONDENSATION

Window condensation issues can be identified by water or ice build-up, usually at the base of the window. The majority of these problems can be addressed by managing moisture generated inside the motorhome. Minor condensation issues are not unusual, especially for RVs used in colder climates. To help minimize window condensation, use exhaust fans vented to the outside, avoid drastic changes in thermostat settings, do not use “vent-free” heaters, and use window coverings wisely. For example, make sure to open curtains or blinds during the day to allow air to circulate and warm the window surface.

CARPET CARE AND MOISTURE MANAGEMENT

The carpet must be cleaned when it shows signs of discoloration or traffic patterns. A steam cleaning system must be used to clean the carpet unless otherwise noted in your warranty information. To manage moisture from the cleaning process, the cleaning system needs to be capable of extracting the excess water from the carpet after it has been cleaned.

IMPORTANT: Be sure the carpet is thoroughly dry before closing up the RV for storage. Water from the cleaning process can cause significant damage to the RV if the carpet is not completely dry before closing up the motorhome for an extended period.

CLEANING TILE AND WOOD FLOORS

Most floors only require a mild detergent and warm water for cleaning. More water on the floor is not always better for cleaning. Use a damp cloth to clean on a regular basis rather than wet mopping each time.

STORAGE AND OTHER ISOLATED AREAS WITHIN THE RV

Storage areas are more difficult to condition since the areas are isolated from the main body of the RV. The surfaces of these areas are more at risk for condensation and surface mold growth. To minimize this risk, clean storage areas regularly, and allow an air space between stored items and the exterior wall to promote air circulation.

USE OF UN-VENTED COMBUSTION EQUIPMENT

Un-vented combustion equipment, such as propane stovetops are a source of moisture within the RV. For every gallon of fuel consumed, approximately one gallon of water vapor is evaporated into the air. Whenever possible, operate an exhaust fan in combination with the use of any un-vented combustion

ROUTINE MAINTENANCE

appliance within the RV. Water vapor and other combustion by-products must be vented to the exterior of the RV. The RV owner must strictly follow use and maintenance instructions for safe operation of any combustion equipment, particularly un-vented equipment.

EXTERIOR CARE OF YOUR RV

The exterior shell of the RV is the primary weather and moisture barrier. Over the life of the vehicle, the shell will require regular care and maintenance in accordance with other instructions for exterior care. The shell includes the roof, sidewalls, windows, doors, and under-floor of the vehicle. Particular attention needs to be devoted to ensure these components are maintained to ensure a tight barrier against bulk water intrusion. The shell must be inspected periodically for tears, gaps, and condition of sealants in accordance with this owner's manual. Areas that require maintenance must be resealed using a similar, high-quality sealant used by the manufacturer. Particular attention must be devoted to ensure the slide outs are functioning properly. Each time a slide out is used, it must be inspected to ensure proper operation and sealing. The slide out gaskets must also be inspected to ensure proper sealing when the slide out is operated.

USE OF YOUR RV

The square footage of an RV is significantly less than that of a single-family residence. This fact alone will elevate the relative humidity because there is less volume of air to help absorb or dissipate the humidity. For example, showering and cooking create a lot of humidity in a small area. In these instances, use of an exhaust fan and opening windows should reduce the relative humidity, particularly when living in the RV for an extended period.

SEVERE ENVIRONMENTS

Prolonged use of your RV in severe environments—for example in extremely cold or hot-humid climates, will require extra care and maintenance to avoid moisture-related issues. In both extremely cold and hot humid climates, more attention needs to be focused on controlling the relative humidity within the RV. It also might require the use of a portable dehumidifier to manage the relative humidity within an acceptable range.

STORAGE OF YOUR RV

During periods when your motorhome is not in use, care must be taken to ensure that moisture sources are addressed. Ideal storage of your RV would be in an enclosed, climate-controlled environment. When this is not possible, the following steps must be taken to ensure moisture is controlled:

- Turn off all water sources.
- Turn off all combustion appliances.
- Drain the water tanks.
- Drain the water heater.
- Open all closets, cabinet doors, and drawers.
- Close all windows and entrance doors.

ROUTINE MAINTENANCE

- Open a vent or a window enough to allow for some limited ventilation airflow, but not so far as to allow snow or rain to enter.
- When storing the RV in high humidity climates, add a dehumidifier drained to exterior to control humidity inside the RV during storage.
- Refer to other sections of this owner's manual for additional recommendations.

MODIFICATIONS TO YOUR RV

Consult Tiffin Motorhomes for guidance before making any modifications to your RV. It is important that changes be completed by a qualified service firm to ensure that moisture intrusion or accumulation problems do not occur.

WET AREAS

Areas that are exposed to water spills or leaks must be dried as soon as possible and definitely within 24 to 48 hours. Drying areas quickly minimizes the chance for moisture damage and possible mold growth, which can begin to form colonies within 48 hours. A variety of methods can be used to help the drying process:

- Remove excess water with an extraction vacuum.
- Use a dehumidifier to aid drying.
- Use portable fans to move air across the surface.
- Because moisture is key to mold issues, treat all signs of condensation and spills seriously and deal with promptly. Failure to deal with a moisture issue promptly might cause more severe issues where none initially existed, or might make a small problem much worse.
- Learn to recognize signs of mold—do not paint over or cover up suspicious discoloration until you are sure it is not mold. The affected surface must first be cleaned and dried; residual staining may be painted.
- Be sure to understand and eliminate the source of moisture accumulation as a part of the clean-up. Otherwise, the same issues will reoccur.
- Small amounts of mold must be cleaned as soon as it appears. Small areas of mold must be cleaned using a detergent/soapy solution or an appropriate RV household cleaner. Gloves must be worn during cleaning. The cleaned area must then be thoroughly dried. Dispose of any sponges or rags used to clean the mold.

ROUTINE MAINTENANCE

TIRE & SAFETY INFORMATION

This portion of the Owner's Manual contains tire safety information as required by 49 CFR 575.6. The National Traffic Safety Administration (NHTSA) can be contacted at 1-888-327-4236. Their website is <http://www.safercar.gov> and their address is NHTSA, 400 Seventh St, S.W., Washington, D.C. 20590.

SECTION ONE

The National Traffic Safety (NHTSA) has published a brochure (DOT HS 809 361) that discusses all aspects of Tire Safety, as required by CFR 575.6. This brochure is reproduced in part below. It can be obtained and downloaded from NHTSA, free of charge, from the following website: <https://one.nhtsa.gov/cars/rules/TireSafety/ridesanit/brochure.html>

Studies of tire safety show that maintaining proper tire pressure, observing tire and vehicle load limits, avoiding road hazards, and inspecting tires for cuts, slashes, and other irregularities are the most important things you can do to avoid tire failure, such as tread separation or blowout, and flat tires.

These actions, along with other care and maintenance activities, can also:

- Improve vehicle handling.
- Help protect you and others from avoidable breakdowns and accidents.
- Improve fuel economy.
- Increase the life of your tires.

This section presents a comprehensive overview of tire safety, including information on the following topics:

- Basic tire maintenance.
- Uniform Tire Quality Grading System.
- Fundamental characteristics of tires.
- Tire safety tips.

Use this information to make tire safety a regular part of your vehicle maintenance routine. Recognize that the time you spend is minimal compared with the inconvenience and safety consequences of a flat tire or other tire failure.

Safety First-Basic Tire Maintenance

Properly maintained tires improve the steering, stopping, traction, and load-carrying capability of your vehicle. Under-inflated tires and overloaded vehicles are a major cause of tire failure. Therefore, as mentioned above, to avoid flat tires and other types of tire failure, you must maintain proper tire pressure, observe tire and vehicle load limits, avoid road hazards, and regularly inspect your tires.

ROUTINE MAINTENANCE

Finding Your Vehicle's Recommended Tire Pressure and Load Limits

Tire information placards and vehicle certification labels contain information on tires and load limits. These labels indicate the vehicle manufacturer's information including:

- Recommended tire size.
- Recommended tire inflation pressure.
- Vehicle capacity weight (VCW—the maximum occupant and cargo weight a vehicle is designed to carry).
- Front and rear gross axle weight ratings (GAWR—the maximum weight the axle systems are designed to carry).

For motorhomes: Both placards and certification labels are on a sticker that is located in the rear closet.

Understanding Tire Pressure and Load Limits

Tire inflation pressure is the level of air in the tire that provides it with load-carrying capacity and affects the overall performance of the vehicle. The tire inflation pressure is a number that indicates the amount of air pressure—measured in pounds per square inch (psi)—a tire requires to be properly inflated. (You will also find this number on the vehicle information placard expressed in kilopascals (kPa), which is the metric measure used internationally).

Vehicle manufacturers determine this number based on the vehicle's design load limit, that is, the greatest amount of weight a vehicle can safely carry, and the vehicle's tire size. The proper tire pressure for your vehicle is referred to as the "recommended cold-inflation pressure."

Because tires are designed to be used on more than one type of vehicle, tire manufacturers list the "maximum permissible inflation pressure" on the tire sidewall. This number is the greatest amount of air pressure that can ever be put in the tire under normal driving conditions.

Checking Tire Pressure

It is important to check your vehicle's tire pressure at least once a month for the following reasons:

- Most tires naturally lose air over time.
- Tires can lose air suddenly if you drive over a pothole or other object, or if you strike the curb when parking.
- With radial tires, it is usually not possible to determine under-inflation by visual inspection.

For convenience, purchase a tire pressure gauge to keep in your vehicle. Gauges can be purchased at tire dealerships, auto supply stores, and other retail outlets.

The recommended tire inflation pressure that vehicle manufacturers provide reflects the proper psi when a tire is cold. The term cold does not relate to the outside temperature. Rather, a cold tire is one that has not been driven on for at least three hours. When you drive, your tires get warmer, causing the air pressure within them to increase. Therefore, to get an accurate tire pressure reading, you must measure tire pressure when the tires are cold or compensate for the extra pressure in warm tires.

ROUTINE MAINTENANCE

Steps for Maintaining Proper Tire Pressure

1. Locate the recommended tire pressure on the vehicle's tire information placard, certification label, or in the owner's manual.
2. Record the tire pressure of all tires.
3. If the tire pressure is too high in any of the tires, slowly release air by gently pressing on the tire valve stem with the edge of your tire gauge until you get to the correct pressure.
4. If the tire pressure is too low, note the difference between the measured tire pressure and correct tire pressure. These "missing" pounds of pressure are what you will need to add.
5. At a service station, add the missing pounds of air pressure to each tire that is under-inflated.
6. Check all the tires to make sure they have the same air pressure (except in cases in which the front and rear tires are supposed to have different amounts of pressure).

If you have been driving your vehicle and think that a tire is under-inflated, fill it to the recommended cold-inflation pressure indicated on your vehicle's tire information placard or certification label.

While your tire might still be slightly under-inflated due to the extra pounds of pressure in the warm tire, it is safer to drive with air pressure that is slightly lower than the vehicle manufacturer's recommended cold-inflation pressure than to drive with a significantly under-inflated tire. Since this is a temporary fix, do not forget to recheck and adjust the tire's pressure when you can obtain a cold reading.

Tire Size

To maintain tire safety, purchase new tires that are of the same size as the vehicle's original tires or another size recommended by the manufacturer. Look at the tire information placard, the owner's manual, or the sidewall of the tire you are replacing to find this information. If you have any doubt about the correct size to choose, consult with the tire dealer.

Tire Tread

The tire tread provides the gripping action and traction that prevent your vehicle from slipping or sliding, especially when the road is wet or icy. In general, tires are not safe and must be replaced when the tread is worn down to 1/16 of an inch. Tires have built-in tread-wear indicators that let you know when it is time to replace your tires. These indicators are raised sections spaced intermittently in the bottom of the tread grooves. When they appear "even" with the outside of the tread, it is time to replace your tires.

Another method for checking tread depth is to place a penny in the tread with Lincoln's head upside down and facing you. If you can see the top of Lincoln's head, you are ready for new tires.

Tire Balance and Wheel Alignment

To avoid vibration or shaking of the vehicle when a tire rotates, the tire must be properly balanced. This balance is achieved by positioning weights on the wheel to counterbalance heavy spots on the wheel-and-tire assembly. A wheel alignment adjusts the angles of the wheels so that they are positioned correctly relative to the vehicle's frame. This adjustment maximizes the life of your tires. These adjustments require special equipment and must be performed by a qualified technician.

ROUTINE MAINTENANCE

Tire Rotation

Rotating tires from front to back and from side-to-side can reduce irregular wear (for vehicles that have tires that are all of the same size). Look in your owner's manual for information on how frequently the tires on your vehicle must be rotated and the best pattern for rotation.

Tire Repair

The proper repair of a punctured tire requires a plug for the hole and a patch for the area inside the tire that surrounds the puncture hole. Punctures through the tread can be repaired if they are not too large, but punctures to the sidewall must not be repaired. Tires must be removed from the rim to be properly inspected before being plugged and patched.

A Tire Rotation Example

For maximum mileage, rotate your tires every 5,000 miles. Follow correct rotation patterns.

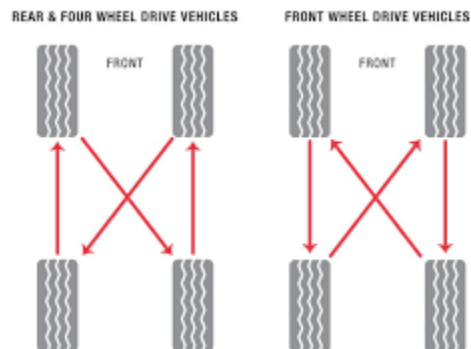
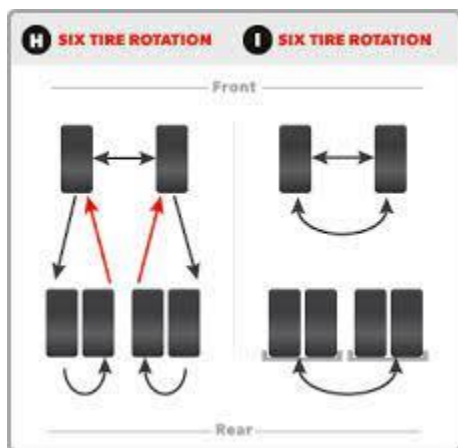
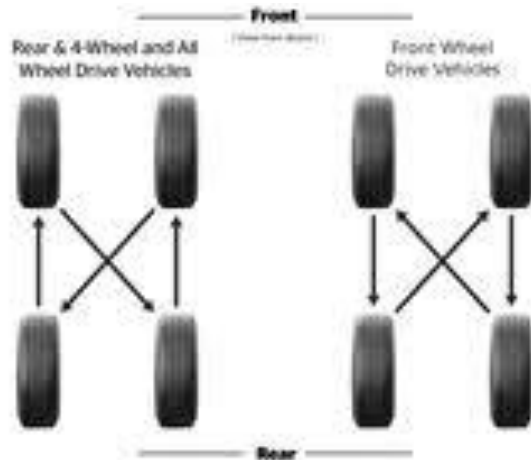
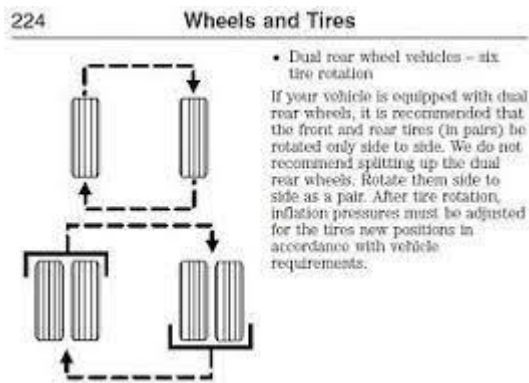

ROUTINE MAINTENANCE

Six Tire Rotation

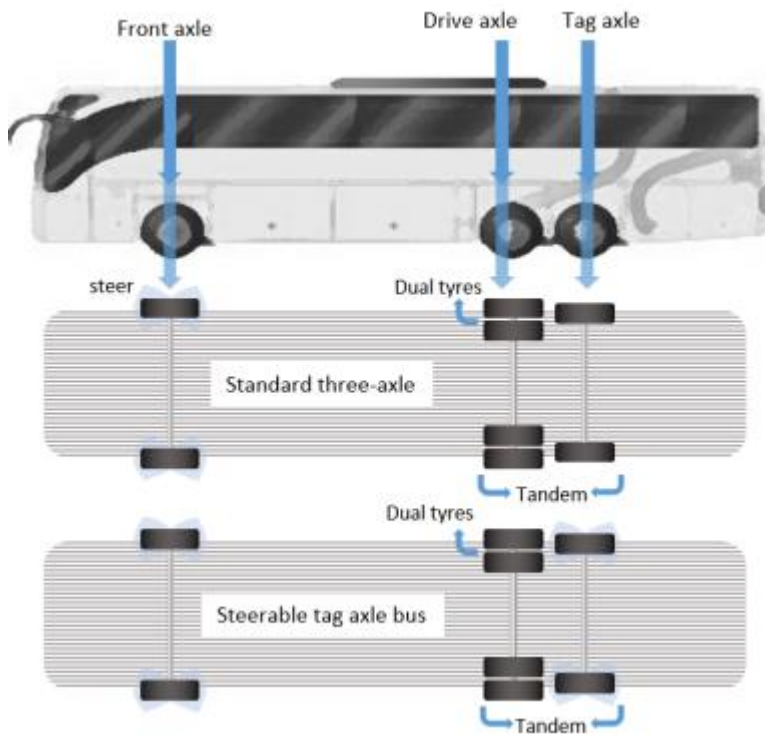
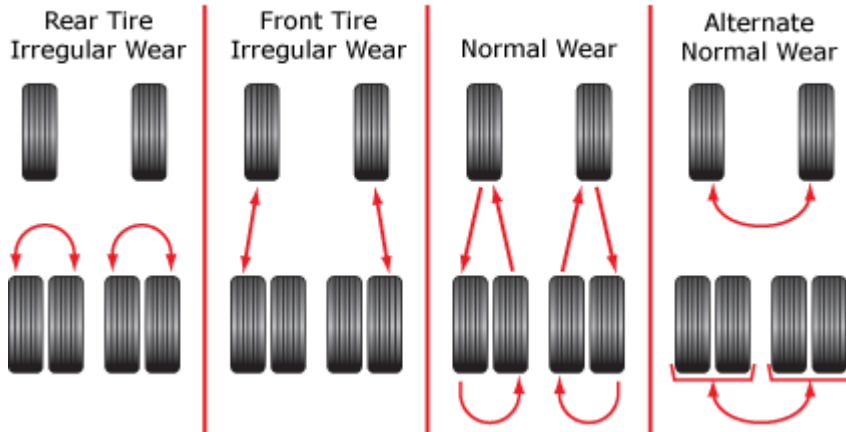

Three-axle diagram from the side and underneath perspectives

ROUTINE MAINTENANCE

Information on Passenger Vehicle Tires

P—The “P” indicates the tire is for passenger vehicles.

NOTE: Passenger car tires are not recommended for use on trailers, because the capacity ratings

TIRE SIDEWALL MARKINGS

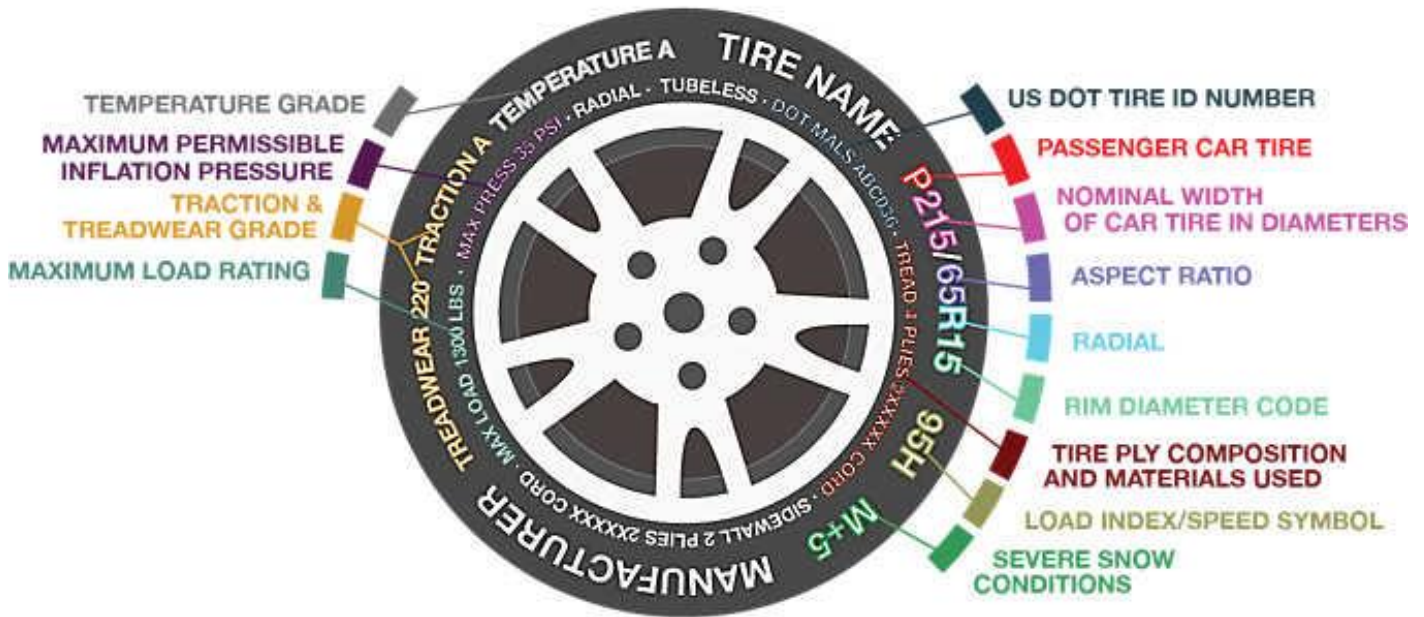

are not marked on the side walls of these tires. In the event that a passenger car tire is used, the capacity must be de-rated by 10%.

Next number—This three-digit number gives the width in millimeters of the tire from sidewall edge to sidewall edge. In general, the larger the number, the wider the tire.

Next number—This two-digit number, known as the aspect ratio, gives the tire’s ratio of height to width. Numbers of 70 or lower indicate a short sidewall for improved steering response and better overall handling on dry pavement.

R—The “R” stands for radial. Radial ply construction of tires has been the industry standard for more than 20 years.

Next number—This two-digit number is the wheel or rim diameter in inches. If you change your wheel size, you will have to purchase new tires to match the new wheel number.

Next number—This two or three-digit number is the tire’s load index. It is a measurement of how much weight each tire can support. You might find this information in your owner’s manual. If not, contact a local tire dealer.

NOTE: You might not find this information on all tires because it is not required by law.

ROUTINE MAINTENANCE

M+S—The “M+S” or “M/S” indicates that the tire has some mud and snow capability. Most radial tires have these markings.

Speed Rating—The speed rating denotes the speed at which a tire is designed to be driven for extended periods of time.

U.S. DOT Tire Identification Number—This begins with the letters “DOT” and indicates that the tire meets all federal standards. The next two numbers or letters are the plant code where it was manufactured, and the last four numbers represent the week and year the tire was built. For example, the numbers 1612 means the 16th week of 2012. The other numbers are marketing codes used at the manufacturer’s discretion. This information is used to contact customers if a tire defect requires a recall.

Tire Ply Composition and Materials Used—The number of plies indicates the number of layers of rubber-coated fabric in the tire. In general, the greater the number of plies, the more weight a tire can support. Tire manufacturers also must indicate the materials in the tire, which include steel, nylon, polyester, and others.

Maximum Load Rating—This number indicates the maximum load in kilograms and pounds that can be carried by the tire.

Maximum Permissible Inflation Pressure—This number is the greatest amount of air pressure that should ever be put in the tire under normal driving conditions.

Vehicle Load Limits

Determining the load limits of a vehicle includes more than understanding the load limits of the tires alone. On a motorhome, there is a federal certification label that is affixed in the rear closet. The certification label will indicate the vehicle’s gross vehicle weight rating (GVWR). This is the most weight the fully loaded vehicle can weigh.

It will also provide the gross axle weight rating (GAWR). This is the most a particular axle can weigh. If there are multiple axles, the GAWR of each axle will be provided. For motorhomes, in the same location as the certification label described above, there is a vehicle placard in the entry door frame. This placard provides tire and loading information. In addition, this placard will show the vehicle’s seating capacity for people and a statement regarding maximum cargo capacity.

Cargo Capacities

For motorhomes, cargo can be added to the vehicle, up to the maximum weight specified on the placard. For motorized vehicles, the combined weight of passengers and cargo is provided as a single number. If fewer people are traveling, more cargo can be added. If more people are involved, the weight of cargo must be reduced. In any case, the total weight of a fully loaded vehicle, including passengers, cannot exceed the stated GVWR.

For motorhomes, the water and propane also need to be considered. The weight of fully filled propane containers is considered part of the weight of the RV before it is loaded with people or cargo and is not considered part of the disposable cargo load. Water, however, is a cargo weight and is treated as such. If there is a fresh water storage tank of 50 gallons, this tank when filled would weigh about 400 pounds. If more cargo or people are being transported, water can be off-loaded to keep the total amount of cargo added to the vehicle within the limits of the GVWR so as to not overload the vehicle.

ROUTINE MAINTENANCE

Understanding this flexibility will allow you to make choices that fit your travel and camping needs. When loading your cargo, be sure it is distributed evenly to prevent overloading from front to back and side-to-side. Heavy items must be placed low and as close to the axle positions as reasonable. Too many items on one side might overload a tire.

The best way to know the actual weight of the vehicle is to weigh it at a certified public scale. Talk to your RV dealer to discuss the weighing methods needed to determine the various weights related to the RV. This will include weights for axles, wheels, hitch, and total weight.

How Overloading Affects Your RV and Tires

The results of overloading can have serious consequences for passenger safety. Too much weight on your vehicle's suspension system can cause spring, shock absorber, or brake failure, handling or steering problems, irregular tire wear, tire failure, or other damage.

An overloaded vehicle is hard to drive and hard to stop. In cases of serious overloading, brakes can fail completely, particularly on steep hills. The load a tire will safely carry is a combination of the size of tire, its load range, and corresponding inflation pressure.

Excessive loads and/or under-inflation cause tire overloading and, as a result, abnormal tire flexing occurs. This situation can generate an excessive amount of heat within the tire. Excessive heat might lead to tire wear and eventually, tire failure.

It is the air pressure that enables a tire to support the load, so proper inflation is critical. Since RVs can be configured and loaded in many ways, air pressures must be determined from actual loads (determined by weighing) and taken from the load and inflation tables provided by the tire manufacturer. These air pressures might differ from those found on the certification label. However, they must never exceed the tire limitation for load or air pressure.

Tire Safety Tips

Preventing Tire Damage

- Slow down if you have to go over a pothole or other object in the road.
- Do not run over curbs or other foreign objects in the roadway, and try not to strike the curb when parking.

Tire Safety Checklist

- ✓ Check tire pressure regularly (at least once a month), including the spare.
- ✓ Inspect tires for uneven wear patterns on the tread, cracks, foreign objects, or other signs of wear or trauma.
- ✓ Remove bits of glass and foreign objects wedged in the tread.
- ✓ Make sure your tire valves have valve caps.
- ✓ Check tire pressure before going on a long trip.
- ✓ Do not overload your vehicle. Check the Tire Information and Loading Placard or User's Manual for the maximum recommended load for the vehicle.

ROUTINE MAINTENANCE

SECTION TWO

Steps for Determining Correct Load Limit

1. Locate the statement “The combined weight of occupants and cargo should never exceed XXX lbs” on your vehicles placard.
2. Determine the combined weight of the driver and passengers that will be riding in your vehicle.
3. Subtract the combined weight of the driver and passengers from XXX kilograms or XXX pounds.
4. The resulting figure equals the available amount of cargo and luggage capacity. For example, if “XXX” equals 1400 lbs. and there will be five 150 lb. passengers in your vehicle, the amount of available cargo and luggage capacity is 650 lbs. (1400-750 (5 x 150) = 650 lbs.)
5. Determine the combined weight of luggage and cargo being loaded on the vehicle. That weight may not safely exceed the available cargo and luggage capacity calculated in Step #4.
6. If your vehicle will be towing a trailer, load from your trailer will be transferred to your vehicle. Consult this section to determine how this reduces the available cargo and luggage capacity of your vehicle.

SECTION THREE

Glossary of Tire Terminology

Accessory weight—The combined weight (in excess of those standard items, which may be replaced) of automatic transmission, power steering, power brakes, power windows, power seats, radio and heater, to the extent that these items are available as factory-installed equipment (whether installed or not).

Bead—The part of the tire that is made of steel wires, wrapped or reinforced by ply cords and that is shaped to fit the rim.

Bead separation—This is the breakdown of the bond between components in the bead.

Bias ply tire—A pneumatic tire in which the ply cords that extend to the beads are laid at alternate angles substantially less than 90 degrees to the centerline of the tread.

Carcass—The tire structure, except tread and sidewall rubber which, when inflated, bears the load.

Chunking—The breaking away of pieces of the tread or sidewall.

Cold-inflation pressure—The pressure in the tire before you drive.

Cord—The strands forming the plies in the tire.

Cord separation—The parting of cords from adjacent rubber compounds.

Cracking—Any parting within the tread, sidewall, or inner liner of the tire extending to cord material.

CT—A pneumatic tire with an inverted flange tire and rim system in which the rim is designed with rim flanges pointed radially inward and the tire is designed to fit on the underside of the rim in a manner that encloses the rim flanges inside the air cavity of the tire.

ROUTINE MAINTENANCE

Curb weight—The weight of a motor vehicle with standard equipment including the maximum capacity of fuel, oil, and coolant, and, if so equipped, air conditioning and additional weight optional engine.

Extra load tire—A tire designed to operate at higher loads and at higher inflation pressures than the corresponding standard tire.

Groove—The space between two adjacent tread ribs.

Gross Vehicle Weight Rating (GVWR)—The maximum permissible weight of this fully loaded motorhome.

Gross Axle Weight Rating (GAWR)—The value specified as the load carrying capacity of a single axle system, as measured at the tire-ground interfaces.

Hitch Weight—The vertical trailer load supported by the hitch ball.

Innerliner separation—The parting of the innerliner from cord material in the carcass.

Intended outboard sidewall—The sidewall that contains a white-wall, bears white lettering or bears manufacturer, brand, and/or model name molding that is higher or deeper than the same molding on the other sidewall of the tire or the outward facing sidewall of an asymmetrical tire that has a particular side that must always face outward when mounted on a vehicle.

Light truck (LT) tire—A tire designated by its manufacturer as primarily intended for use on light-weight trucks or multipurpose passenger vehicles.

Load rating—The maximum load that a tire is rated to carry for a given inflation pressure.

Maximum load rating—The load rating for a tire at the maximum permissible inflation pressure for that tire.

Maximum permissible inflation pressure—The maximum cold-inflation pressure to which a tire may be inflated.

Maximum loaded vehicle weight—The sum of curb weight, accessory weight, vehicle capacity weight, and production options weight.

Measuring rim—The rim on which a tire is fitted for physical dimension requirements.

Non-pneumatic rim—A mechanical device which, when a non-pneumatic tire assembly incorporates a wheel, supports the tire, and attaches, either integrally or separably, to the wheel center member and upon which the tire is attached.

Non-pneumatic tire assembly—A non-pneumatic tire, alone or in combination with a wheel or wheel center member, which can be mounted on a vehicle.

Normal occupant weight—This means 68 kilograms (150 lbs.) times the number of occupants specified in the second column of Table I of 49 CFR 571.110.

Occupant distribution—The distribution of occupants in a vehicle as specified in the third column of Table I of 49 CFR 571.110.

Open splice—Any parting at any junction of tread, sidewall, or innerliner that extends to cord material.

Outer diameter—The overall diameter of an inflated new tire.

ROUTINE MAINTENANCE

Overall width—The linear distance between the exteriors of the sidewalls of an inflated tire, including elevations due to labelling, decorations, or protective bands or ribs.

Pin Weight—The vertical trailer load supported by the king pin of a fifth wheel hitch.

Ply—A layer of rubber-coated parallel cords.

Ply separation—A parting of rubber compound between adjacent plies.

Pneumatic tire—A mechanical device made of rubber, chemicals, fabric and steel, or other materials, that, when mounted on an automotive wheel, provides the traction and contains the gas or fluid that sustains the load.

Production options weight—The combined weight of those installed regular production options weighing over 2.3 kilograms (5 lbs.) in excess of those standard items which they replace, not previously considered in curb weight or accessory weight, including heavy duty brakes, ride levelers, roof rack, heavy duty battery, and special trim.

Radial ply tire—A pneumatic tire in which the ply cords that extend to the beads are laid at substantially 90 degrees to the centerline of the tread.

Recommended inflation pressure—This is the inflation pressure provided by the vehicle manufacturer on the Tire Information label and on the Certification/VIN tag.

Reinforced tire—A tire designed to operate at higher loads and at higher inflation pressures than the corresponding standard tire.

Rim—A metal support for a tire or a tire and tube assembly upon which the tire beads are seated.

Rim diameter—This means the nominal diameter of the bead seat.

Rim size designation—This means the rim diameter and width.

Rim type designation—This means the industry of manufacturer's designation for a rim by style or code.

Rim width—This means the nominal distance between rim flanges.

Section width—The linear distance between the exteriors of the sidewalls of an inflated tire, excluding elevations due to labelling, decoration, or protective bands.

Sidewall—That portion of a tire between the tread and bead.

Sidewall separation—The parting of the rubber compound from the cord material in the sidewall.

Test rim—The rim on which a tire is fitted for testing, and may be any rim listed as appropriate for use with that tire.

Tread—That portion of a tire that comes into contact with the road.

Tread rib—A tread section running circumferentially around a tire.

Tread separation—Pulling away of the tread from the tire carcass.

Treadwear indicators (TWI)—The projections within the principal grooves designed to give a visual indication of the degrees of wear of the tread.

ROUTINE MAINTENANCE

Vehicle capacity weight—The rated cargo and luggage load plus 68 kilograms (150 lbs.) times the vehicle’s designated seating capacity.

Vehicle maximum load on the tire—The load on an individual tire that is determined by distributing to each axle its share of the maximum loaded vehicle weight and dividing by two.

Vehicle normal load on the tire—The load on an individual tire that is determined by distributing to each axle its share of the curb weight, accessory weight, and normal occupant weight (distributed in accordance with Table I of CFR 49 571.110) and dividing by 2.

Weather side—The surface area of the rim not covered by the inflated tire.

Wheel center member—In the case of a non-pneumatic tire assembly incorporating a wheel, a mechanical device which attached, either integrally or separably, to the non-pneumatic rim and provides the connection between the non-pneumatic rim and the vehicle; or, in the case of a non-pneumatic tire assembly not incorporating a wheel, a mechanical device which attaches, either integrally or separably, to the non-pneumatic tire and provides the connection between tire and the vehicle.

TIRE PRESSURE

Correct tire inflation pressure is essential to maximizing the life of the tires and assuring the safety of the vehicle and its occupants. Driving with tires that are not correctly inflated for the load of the motorhome is dangerous and might cause premature wear, tire damage, and/or loss of control of the motorhome.

An underinflated tire will build up excessive heat that might actually approach the vulcanization temperature of the rubber and lead to tread separation and/or disintegration of the tire.

Underinflated tires will also cause poor handling of the motorhome, rapid and/or irregular tire wear, and an increase in rolling resistance of the motorhome, which, in turn, produces a decrease in fuel economy of operation.

An overinflated tire will reduce the tire’s “footprint” (i.e., its actual contact with the road); thus, reducing the traction, braking capacity, and handling of the motorhome. A tire that is over-inflated for the load that it is carrying will also contribute to a harsh ride, uneven tire wear, and the tire itself will be more susceptible to impact damage.

Maintaining correct tire pressure for each loaded wheel position on the motorhome is critically important and must be a part of regular vehicle maintenance.

Tire Maximum Load Rating

Federal law requires that the maximum load rating be moulded into the sidewall of the tire. If you look at a tire sidewall, you might see some “typical” information, such as:

Max. Load Single 3640 Lbs at 85-psi cold

Max. Load Dual 3415 Lbs at 85-psi cold

The maximum load allowed for the size of the tire and load rating and the minimum cold air-inflation pressure needed to carry that stated maximum load are noted on the tire. Using less air pressure would reduce the load-carrying capacity of the tire.

ROUTINE MAINTENANCE

NOTE: The amount of air pressure you need depends on the weight of the fully loaded motorhome. You cannot determine the correct air-inflation pressure, unless you know the actual weights of the motorhome.

Weighing the Motorhome

Earlier, in Chapter 1, the procedures for weighing the motorhome were presented. These procedures provided the weighing of a “non-loaded” (i.e., not stocked with the possessions and provisions the user would normally have on-board for travel) motorhome. Obviously, any additional weight stored onboard (inside and underneath) the motorhome will contribute to the overall weight of the motorhome.

If not stored uniformly throughout the motorhome, additional weight of the possessions and provisions of the motorhome user will load each axle and each tire differently (front-to-rear and side-to-side distribution of that additional weight). Accordingly, **it is necessary to weigh the motorhome fully loaded, as the user would have it for travel. Moreover, it is necessary to weigh each tire position individually.**

Overloading the motorhome can produce problems with the tires, wheels, springs, brakes, drive train, and other motorhome assemblies. In addition, an overloaded motorhome uses more fuel, is more difficult to handle properly, and can lead to driver fatigue more quickly. In a worst-case condition, if any component should fail, this could result in loss of control of the motorhome and subsequent damage.

In certain states, the Highway Patrol routinely weighs motorhomes to check for overloaded axle weights. Therefore, there are many good reasons for assuring that the motorhome is properly loaded and not overloaded—this can be accomplished through a proper weighing of the fully loaded motorhome.

You can find various places that have certified public scales where your motorhome can be weighed. For example, moving and storage company lots, farm suppliers with grain elevators, gravel pits, recycling companies, and large-scale commercial-truck stops are some of the possible locations for weighing the motorhome. You can also check the Yellow Pages of the telephone book for “scales – public” or “weighers” to determine other locations for weighing the motorhome.

ROUTINE MAINTENANCE

A brief overview of the procedure for weighing the motorhome

WEIGHING YOUR SINGLE AXLE RECREATIONAL VEHICLE

RV: To Obtain Individual Axle and Gross Vehicle Weights:

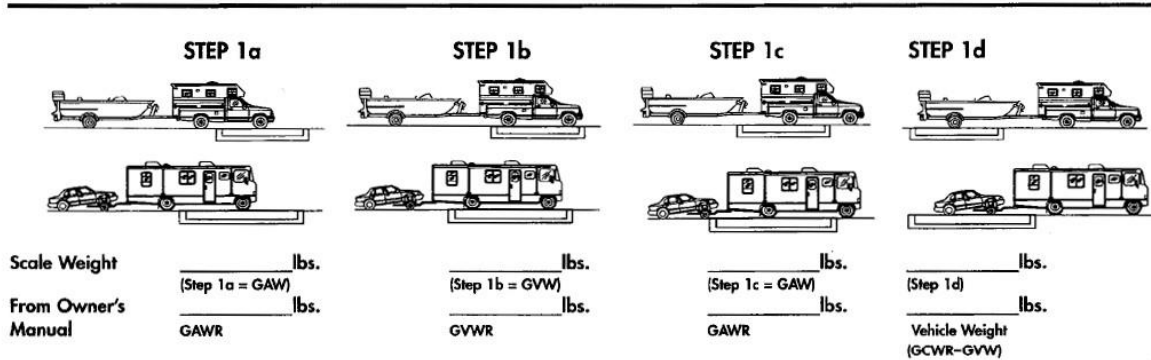

To Obtain Individual Wheel Position Weights:

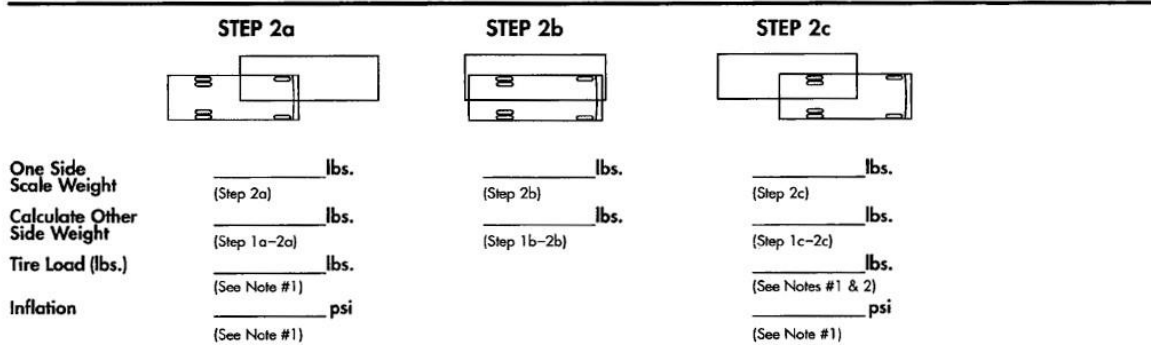

Figure 17-3: Motorhome Weighing Procedures

NOTE: Tire manufacturer's load and inflation tables can be found on the sidewall of the tires mounted on the motorhome.

NOTE: If the motorhome has duals, read dual capacity from the tire and multiply by 2 (two) to obtain dual-assembly load-carrying capacity.

More detailed information can be found in the manufacturer's literature associated with the chassis and/or the tires provided with the motorhome. For example, the above graphic illustrates the inflation pressures for Michelin tires as a function of the loads per position for a specified speed of the motorhome. You can determine the appropriate inflation pressures for each of the tires on the motorhome, as a function of the loads they are to carry on a trip. Whenever there is a significant change in the loading regimen of the motorhome, it would be wise to re-calculate the load weights of the tires to ensure optimal use of the motorhome.

ROUTINE MAINTENANCE

Frequency of Checking Tire Inflation Pressures

When you have determined the “correct” tire inflation pressures for each of the motorhome tires (Figure 17-4 and Figure 17-5) and inflated the tires under “cold” conditions, meaning the tires haven’t been driven for more than one mile, then the air pressures in the tires must be periodically checked to make sure that they retain their proper pressures. It is recommended that tire pressures be checked at least once a month, or preferably, every two weeks, and before any major trip.

On long trips, the tires must be checked every “drive” morning. On short trips (a day or less), the tires must be checked before one departs on the trip and again before one returns home.

Check tire pressures when they are “cold”; that is, the tires have not been driven at all or, at most, less than one mile before being measured. In this manner, the tire pressure has not been increased by the heating associated with tire sidewall and tread flexure associated with traveling. If you check tires that are warm or hot, remember

that they will necessarily read higher than normal. Do not “bleed” these tires down to the “cold pressure” readings, as they will probably then be underinflated when they are actually cool.

Do not make any adjustments to tire pressures when the tires are warm or hot, if such can be avoided. To make these tire-pressure measurements, purchase a high-quality truck-tire air gauge, which has an angled dual head. This type of gauge enables you to check inflation pressures of both the inner dual wheel, which has the valve stem pointing toward one, and on the outer wheel, which has the valve stem pointing away from one.



Figure 16:4 Instrument Panel
Tire Pressure Monitor



Figure 17-4: Rear Tire



Figure 17-5: Front Tire

Pressure-sealing valve caps must always be used to protect the valve stems and prevent air from escaping from the valve stems.

ROUTINE MAINTENANCE

Tire Wear, Balance, and Wheel Alignment

In addition to tire inflation considerations, the tires must also be periodically examined for other types of normal “wear and tear.” If installed and maintained properly, all tires mounted on the motorhome will wear in a smooth, even pattern. If the tires begin to show irregular wear patterns and the motorhome alignment is still correct, then sometimes just rotating the tires by changing wheel position and rotation of the tires will allow the tires to wear evenly.

Check with the chassis manufacturer (Power Glide) and its literature in the Owner’s Information Package for particulars on maintaining proper wheel alignment.

Tire Cleaning

Proper cleaning of the tires will ensure maximum years of service. A soft brush and the normal mild soap must be used to clean the tires. Use care in applying any tire “dressing” product as these contain petroleum derivatives, alcohol, or silicones, which might cause deterioration of the rubber, possibly leading to cracking, and accelerate the aging process. In many instances, it is not the actual dressing itself, but the reaction of that product with the antioxidant in the tire. Heat can also compound this problem.

INTERIOR CARE

NOTICE

The fading of upholstery, carpet, and other interior fabrics is generally caused by excessive sunlight. The drapes, blinds, or other shades must be kept closed when the vehicle is parked for an extended period of time to minimize the fading. Normal deterioration of the appearance of such items caused by wear and/or exposure to strong lighting is not covered by the Tiffin Motorhomes Limited Warranty.

FABRICS

The fabrics (**Error! Reference source not found.**), used in this Tiffin motorhome for the bedspread, draperies, headboard, and valances contain fire-retardant additives that might be damaged by use of improper cleaning products.

These items are DRY CLEAN ONLY. Water-based products are not recommended for cleaning the fabrics in your new vehicle. Most water-based, household-cleaning products are not formulated for use

ROUTINE MAINTENANCE

on these fabrics and might cause excessive shrinkage or fading. For best results, the fabrics in this vehicle must be cleaned by a professional carpet and upholstery cleaner.

Spills, spots, or stains must be treated as soon as possible to avoid permanent damage to the fabrics. If a spill occurs, blot the fluid with a dry towel, do not rub the spill as rubbing might cause the liquid to “set” in the fabric and cause a stain. When attempting to clean a spot or stain, always start from the outside and work inward to avoid spreading the stain further. Some stains or soils are extremely difficult or impossible to be removed completely. These stains must receive immediate professional attention. Spills, spots, stains, or soiled areas are the responsibility of the owner and are not covered by Tiffin Motorhomes Limited Warranty.

	WARNING
<p>When cleaning the upholstery and fabric of the motorhome, do not use lacquer thinner, nail polish remover, laundry soaps, or bleach. Never use carbon tetrachloride or gasoline for cleaning purposes. These substances might cause damage to the materials being cleaned and most are highly flammable.</p>	

WALLS & CEILING

The wall and ceiling coverings must be cleaned periodically to maintain a new appearance. Use a non-abrasive cleaner with a soft cloth on the walls. Do not use solvents of any kind, as those solvents might damage the surfaces being cleaned.

DASHBOARD

To keep the motorhome dashboard (Figure 17-6) in like-new condition, regularly follow these guidelines:

DOs

- Dust and clean the dashboard with a soft, damp cloth or chamois, wiping the surface gently.
- Use a mild detergent and lukewarm water.
- After washing and rinsing the dashboard, dry it by blotting with a damp cloth or chamois.



Figure 17-6: Dashboard

DON'Ts

- Use harsh chemicals that might damage the dashboard.

ROUTINE MAINTENANCE

- Use cloths containing grit or abrasive particles or kitchen-scouring compounds to clean or dust the dashboard.
- Subject the dashboard to hard, direct blows.
- Use boiling water, strong solvents, or other such materials to clean the dashboard, as they will soften the plastic.

WOODWORK & FLOORS

The wood cabinetry must be cared for with furniture polish to sustain the natural beauty and luster of the wood. This procedure will also keep the cabinetry (Figure 17-7) looking new, prevent the wood from drying, and reduce chances of accidental staining or aging.

Use area rugs and floor mats by the entrance door to trap dirt.

Use soap and water to clean the flooring, begin by vacuuming the floor to remove loose dust and dirt. Then, damp mop the floor with a cleaning solution consisting of any standard cleaning solution. The mop must be damp, but not dripping. For further tips, see the manufacturer's information sheet in your Tiffin Motorhomes Owners Information Package.



Figure 17-7: Kitchen Cabinetry

COUNTERTOPS

To care properly for the countertops in your new vehicle, always use a heat pad or trivet to protect the surface from hot objects that might mar or damage the countertop surface. Hot pans and heat-producing appliances (such as electric skillets), when set directly on top of the countertop, can possibly mar the beauty and finish of the product.

Additionally, since heat-producing appliances can also damage countertop seams, it is essential to check with Tiffin Motorhomes to identify seam locations to avoid them during subsequent use of the motorhome. Although solid surfacing is repaired easily, certain steps must be taken to protect it.

Be sure to use a cutting board, rather than cutting directly on the countertop (Figure 17-8) surfaces. Although minor scratches and cuts can be repaired, a little care will ensure that the counter-top surfaces will keep looking new for years.

Avoid using harsh chemicals on the countertop. Wipe the countertop with a damp cloth to remove water spots. For most dirt and stains, wipe with a damp cloth and use soapy water or ammonia-based cleaners (e.g., Windex). If a stain does not respond to soap and water, for a matte finish, apply an abrasive cleanser and buff it with a Scotch-Brite pad, using a circular motion. Use the same technique in the case of a cigarette burn. If the finish is a gloss finish, contact the dealer for specific cleaning instructions.



Figure 17-8: Kitchen Countertops

ROUTINE MAINTENANCE

Do not expose the surface to harsh chemicals, such as paint remover, turpentine, nail polish remover, or any stove and drain cleansers. If these chemicals come into contact with the countertop surfaces, immediately wash off these chemicals, using appropriate safety measures to avoid injury.

In the event of subsequent staining or spotting, sand the affected surface lightly with fine sandpaper (400 grit or finer), then buff in a circular motion with a Scotch-Brite pad.

ACCESSORIES

The metallic light fixtures, bath accessories, and faucets can be cleaned by wiping with a soft, damp cloth. Washing with warm water will remove dry water spots. Polishing those fixtures with a soft cloth will also enhance their appearance. Do not use cleaners that contain harsh or abrasive chemicals. Alcohol or other similar solvents must never be used.

DETECTORS

The CO/LP gas detectors (Figure 17-9) are self-contained and DO NOT require any maintenance other than normal cleaning and periodic testing. The smoke detector installed in the motorhome is a 9 volt, battery-operated detector. The CO/LP gas detector is wired directly to the house batteries.

The batteries in the smoke detector need to be tested periodically and replaced when necessary. When cleaning the case on any of the detectors, use a damp cloth or paper towel. Do not spray cleaners or wax directly into the case as this action might cause false alarms or hinder the normal operation of the detectors.

Tiffin Motorhomes recommends purchasing an inexpensive battery tester. This tester will allow checking of the batteries in the various alarms, any flashlights used in the motorhome, and batteries in other appliances, which might be in the motorhome during travels.



Figure 17-9: Smoke Detector

CONDENSATION

NOTICE

Since surface condensation within the motorhome cannot be controlled by the manufacturer, damage caused by condensation is not covered by the Tiffin Motorhomes Limited Warranty.

Damage might occur to your vehicle if excessive condensation exists. Accumulation of condensation on surfaces within your motorhome occurs when warm, moist air contacts a cool surface. It is most evident on the inside of windows, but this problem can be controlled by:

ROUTINE MAINTENANCE

1. Slightly opening a window or roof vent to allow the moisture to escape from the motorhome.
2. Using a small dehumidifier to remove moisture from the air.

Condensation levels are highest during times when a person is cooking or taking a shower in the motorhome, but these occasions are not the only times that condensation is present. Walls and ceiling panels might become wet when the moisture accumulates on these surfaces. Tiffin Motorhomes does not recommend the use of any catalytic heaters because of resulting extensive condensation.

ROUTINE MAINTENANCE SCHEDULES

NOTICE

Always follow the chassis maintenance guidelines outlined in the chassis manufacturer's owner's manual.

All routine maintenance is the responsibility of the owner and is not covered by the Tiffin Motorhomes Limited Warranty. Use the maintenance record in Chapter 18 to record all performed maintenance as required.

Any damage caused by improper or unperformed maintenance is not covered by the Tiffin Motorhomes Limited Warranty. Items supplied by other manufacturers might require specific individual maintenance not listed herein. Refer to the manufacturers' suggested maintenance guidelines in the Owners Information Package.

NOTICE

Cosmetic adjustments and alignments must be performed within the first three months from the date of original purchase for warranty consideration. Thereafter, these items are considered routine maintenance.

Monthly

- Check the water levels of the batteries.

Every Three Months

- Check LP gas lines for leaks with soap solution or leak detector.
- Clean the microwave hood exhaust fan filter and blades.

ROUTINE MAINTENANCE

- Test smoke alarm and carbon monoxide/LP gas detector.
- Check operation of windows, latches, and hinges.
- Clean the roof-ducted air conditioner filters.
- Clean and inspect door and window seals; reseal where necessary.
- Inspect and reseal around the tub and shower area where necessary.
- Lubricate the exterior door hinges and latches with a graphite (silicone) lubricant.
- Check, clean, and tighten battery cables and inspect batteries for proper fluid levels.

Every Six Months

- Inspect the slide-out for proper seal. If realignment is necessary, contact an authorized Tiffin Motorhomes Service Center.
- Inspect the exterior rubber slide-out seals and apply a UV inhibitor, such as 303 Protectant.
- Change the battery in the smoke detector.
- Rotate tires as recommended by the tire manufacturer.
- Check all gas appliances for proper operation.
- Have the LP system inspected by a qualified technician.
- Lubricate the movable parts on the entrance step.
- Change the batteries in both the smoke detectors.
- For the optional washer/dryer, inspect the water hoses (both the hot and cold supply lines) to note any bulges, kinks, cuts, wear, or leaks. Especially note the hot-water hose, as this tends to degrade faster than the cold-water hose. Replace if hose feels “soft” or “spongy.”

Annually

- Inspection of roof seams and joints must be performed by an authorized Motorhomes Service Center. If resealing is necessary, it is the owner’s responsibility and is not covered by the Tiffin Motorhomes Limited Warranty.
- Sanitize the fresh water system.
- Wax and buff all gel-coat surfaces on the vehicle as described previously in this chapter.

ROUTINE MAINTENANCE

WINTERIZING

To store your vehicle for the winter months, it is necessary to winterize the water system to help prevent freezing of this system. If your unit has a Truma Water Heater, be sure to follow the instructions in the Operations Manual. The control panel is located in the bedroom closet.



Figure 17-10: Truma Switch

IMPORTANT: Turn off the water heater before draining to prevent burning the element out.

1. Drain all the water from the water system including the holding tanks, the hot water heater, and freshwater tank. Also, drain the water filter. For the holding tanks, open the gate valves to drain the tanks.

NOTE: This procedure is to be performed only at a wastewater pumping station to prevent dumping of contaminated water elsewhere.

For the hot water heater, remove the outside cover and then remove the drain plug. When this tank is drained, replace the drain plug and then replace the cover. For the water tank, open the red-handled valve to drain the tank; then close the valve. Remove the filter cartridge from the water filter and store it in a clean environment. Empty any excess water from the filter housing and replace the housing.

2. Turn the by-pass valve located in the exterior sanitation compartment to the “by-pass” position to prevent filling the water heater tank with antifreeze.
3. Disconnect the inlet connection to the water pump located in the sanitary service compartment under the motorhome. Attach the supplied vinyl hose (through the plastic coupling on the hose) to the inlet connection and hand-tighten that connection. Do not over-tighten.
4. Place the other end of the hose into a gallon of freshwater system antifreeze (one can refer to the local Tiffin Motorhomes dealer or representative for the freshwater antifreeze formulation for your specific area).

NOTE: Do not use automotive antifreeze; use only antifreeze approved for RV applications. Otherwise, damage to the systems being protected might result.

5. Turn ON the water pump to start the flow of antifreeze. Turn ON each faucet, one at a time and allow pure antifreeze to run through that piping. Let about one cup drop into the drains to protect the traps.
6. When all the antifreeze is withdrawn from the bottle, disconnect the clear vinyl hose from the water-pump inlet connection and reconnect the inlet line to the water pump. (This might require more than one gallon of antifreeze).
7. When the winterizing process is completed, turn the water pump OFF and then reconnect the water line. Store the vinyl hose for future use.
8. Open the water supply valve that controls flow from the pump to the tank to help prevent freezing on that water line.

ROUTINE MAINTENANCE

NOTE: The motorhome also has an exterior shower that must be winterized, as well.

If the motorhome is equipped with an optional ice maker, the following additional steps must be taken.

Dometic Refrigerator Ice Maker (optional)

1. Shut off the water supply to the icemaker.
 2. Place a shallow pan under the water solenoid valve.
 3. Remove the inlet fitting to the icemaker water solenoid valve. Then, drain the water from the supply line.
 4. Remove the plastic nut and water line from the outlet side of the water solenoid valve. Then, drain the water from that line.
-

NOTE: Do not lose the metal insert from the plastic water line. One recommended way to secure this insert is to place it into a “zip lock” bag, seal the bag, punch a small hole through the top of the bag above the zip-lock, insert any type of “twist-tie” through the hole, and then secure that bag to the outlet line for safekeeping.

5. Connect a source of compressed air (up to 20 psig) onto the inlet fitting of the water solenoid valve. Apply AC power to the solenoid valve for forcing the icemaker mold assembly through several harvest cycles.
 6. Remove the plastic cover from the mold assembly. The bail arm must be in the DOWN (or ON) position.
 7. Start the harvest cycle with a flat-blade screwdriver inserted into the center of the small gear.
 8. Turn the gear counter clockwise (CCW). When the hold switch closes, the mold assembly will continue to operate through the harvest cycle. During the water-fill sequence of the harvest cycle, the compressed air will blow out the water trapped in the solenoid valve.
 9. Repeat the harvest cycle operation (i.e., steps 7 and 8) several times.
-

NOTE: Damage to the solenoid valve can occur if the AC power is applied for more than 20 seconds.

10. Reconnect and tighten the lines on the water solenoid valve. The metal insert must be installed in the plastic water line going to the outlet side of the water solenoid. Leave the water supply turned OFF until temperatures are above 0° F (-18° C).
11. Dry out the icemaker mold assembly with a soft cloth. Place the bail arm in the UP (OFF) position.

Residential Refrigerator Ice Maker (optional)

1. Unplug refrigerator or disconnect power.
 2. Locate the water supply shut off valve and turn OFF the water supply.
 3. Disconnect the water supply line at the refrigerator and drain the supply line completely.
-

ROUTINE MAINTENANCE

4. Locate the icemaker fill tube at the rear of the refrigerator and follow the water line down to the water valve.
5. Remove any covers if necessary.
6. Disconnect the water line from the water valve, and drain the water from the line and the valve. Use a small pan to catch water.
7. Remove the water filter cartridge (if applicable.)

NOTE: Reinstall a new water filter cartridge when the refrigerator is put back into service.

DE-WINTERIZING

Follow the instructions in your water system's Operations Manual.

1. Open both of the low-point drains to allow the antifreeze solution to drain from the water system.
2. Close the low-point drains and connect your vehicle to the city water system. Put water in the freshwater tank and pump at least one gallon through the water pump to remove the antifreeze from the water pump. Keep the water heater in the bypass mode.
3. Open the kitchen faucet, bath faucet, and inside and outside showers, turning ON both the hot and cold-water valves and flushing the stool until the antifreeze solution is flushed out of the system and the water flow is clear.
4. Open the water heater bypass valve. Open the freshwater tank supply valve from the pump and the icemaker valve.
5. Reinstall the (optional) water filter. Fill the water heater and hot water lines before turning the water heater on.
6. Be sure to close the fresh water tank drain valves to allow the tank to fill.

WAYFARER

MAINTENANCE & DATA CHARTS

Chapter

18

RV OWNER DATA SHEET

Enter the following information in the table for your future use:

Wayfarer: Year: _____ Model # _____ Tiffin Serial# _____			
Appliance	Brand	Model No.	Serial No.
Refrigerator			
Water heater			
Microwave			
Inverter/Converter			
Television, Front			
Back-up monitor			
Stereo/CD			
DVD home theater			
Air conditioner			
Generator			
Dishwasher			
Washer/Dryer			

Reproduction Master – Copy this sheet and use copy to maintain your maintenance records. You might wish to keep the completed sheets in a three-ring binder for your permanent record.



TIFFIN

MOTORHOMES

Tiffin Motorhomes, Inc. | 105 2nd St. NW | Red Bay, AL 35582
tiffinmotorhomes.com

Phone: 256-356-8661 | Email: customersupport@tiffinmotorhomes.com

To view or download a full color, printable version of this owner's manual, visit
www.tiffinmotorhomes.com/resources/owners-manual

OR SCAN BELOW

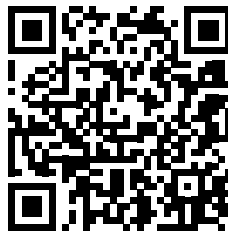

Because of progressive improvements and specifications, standard and optional equipment are subject to change without notice or obligation. For a complete and up-to-date list of available options and specifications, visit tiffinmotorhomes.com.

©2024 Tiffin Motorhomes, Inc.

Allegro®, Allegro Breeze®, Allegro RED®, Phaeton®, Allegro Bus®, Zephyr®, Wayfarer®, Roughing It Smoothly®, Open Road®, PowerGlide®, and Cahaba® are registered trademarks of Tiffin Motorhomes, Inc. All rights reserved.