



**TIFFIN**

MOTORHOMES

**2024 Owner's Manual**



**ALLEGRO BUS**



# TIFFIN

## MOTORHOMES

### **DISCLAIMER**

Many of the features and appliances described in this manual might not be reflected in the actual motorhome purchased, depending on the options and models selected by the motorhome owner. All items, materials, instructions, and guidance described in this manual are as accurate as possible at the time of printing. However, due to Tiffin Motor Homes' ongoing and dedicated commitment to excellence, improvement of Tiffin's motorhomes is a continuing process. Consequently, Tiffin Motor Homes reserves the right to make substitutions and improvements in its makes and models of motorhomes without prior notification. Substitutions of comparable or better materials, finishes, appliances, instrumentation, and instruction might be made at any time it is deemed prudent to provide the customer with the best possible motorhome, meeting the customer's requirements.

Copyright © by Tiffinmotorhomes, Inc. - all rights reserved

Tiffin Motor Homes, Inc. ©  
105 2nd St. NW • Red Bay, AL 35582  
Phone: 256-356-8661  
Fax: 256-356-8219

Email: [customersupport@tiffinmotorhomes.com](mailto:customersupport@tiffinmotorhomes.com)

[www.tiffinmotorhomes.com](http://www.tiffinmotorhomes.com)

[www.tiffinmotorhomes.com](http://www.tiffinmotorhomes.com)





TIFFIN

# Many Adventures. One Dream.™



There are many ways to adventure in our products, but all customers share a similar dream of leisure, exploration, and fun while making lifelong memories with the most important people in their lives.

Our products are the vehicle for customer's adventures and helping them realize their dreams.

# TABLE OF CONTENTS

<b>1 General Information .....</b>	<b>1</b>
Welcome to a life of “roughing it smoothly” .....	2
About This Manual .....	2
Delivery .....	3
Dealer Responsibilities.....	3
Customer Responsibilities .....	3
Reporting Safety Defects (Usa).....	4
Reporting Safety Defects (Canada).....	4
Tiffin Motor Homes Limited Warranty .....	5
Major Equipment Manufacturers .....	6
Warranty Service .....	6
Owner’s Information Package .....	7
Customer Relations .....	7
Specification Labels .....	7
Weighing Procedures.....	9
Weight Distribution.....	9
Safety Messages .....	9
<b>2 Safety Instructions .....</b>	<b>11</b>
Safety Considerations .....	12
General Warnings .....	12
Pre-Departure Checklist .....	13
Driving Safety .....	14
Fuels for the Motorhome .....	15
Carbon Monoxide Warning.....	16
CO/LP Gas Detector.....	16
Fire Safety .....	18
Fire Extinguisher .....	18
Smoke Detector.....	19
Electrical .....	19
Loading .....	20
Maintenance .....	20
Emergency Exits.....	20
Parking Procedures .....	21
Towing Hitch .....	21
<b>3 Spyder Controls System .....</b>	<b>23</b>
Spyder Controls System .....	24



# TABLE OF CONTENTS

<b>4 Heating &amp; Air Conditioning .....</b>	<b>25</b>
Aqua-Hot Heating System .....	26
Air Conditioning System .....	27
Air Conditioning Controls .....	28
Thermostat on Spyder Controls System .....	29
Heat Pump Controls.....	30
<b>5 Major Appliances .....</b>	<b>31</b>
Residential Refrigerator .....	32
Wood Refer-Panel Refrigerator (Optional).....	33
Microwave/Convection Range .....	34
Air Filtration Fan.....	34
True Induction CookTop/Wolf Cooktop (Optional) .....	35
Dishwasher (Optional) .....	37
Stacked Washer/Dryer (Optional) .....	38
<b>6 Entertainment.....</b>	<b>39</b>
Television Antenna.....	40
Television Satellite Dish.....	40
Television Sets .....	41
Television Lift In Living Room (Optional On Some Models).....	42
Television Lift in Bedroom (Optional) .....	43
Exterior Television .....	44
Infrared Repeater .....	44
Sound Bar .....	45
Blu-ray Player .....	45
<b>7 Cabinets &amp; Furniture .....</b>	<b>46</b>
Cabinets.....	47
Slide-Out Pantry .....	49
Furniture .....	50
Kitchen, Living & Dining Areas .....	50
Bedroom Area.....	53
Power Smart Bed .....	53
<b>8 Structural Features .....</b>	<b>54</b>
Chassis Features .....	55
<b>9 Electrical Features .....</b>	<b>56</b>
General Information.....	57

# TABLE OF CONTENTS

<b>Electrical Cautions</b> .....	<b>58</b>
<b>Circuit Breaker Boxes</b> .....	<b>58</b>
<b>Auxiliary Start Switch</b> .....	<b>60</b>
<b>Battery Inspection and Care</b> .....	<b>61</b>
<b>House Battery Disconnect Panel</b> .....	<b>63</b>
<b>Engine Battery Disconnect Panel</b> .....	<b>64</b>
<b>EXTERNAL Solar Port</b> .....	<b>64</b>
<b>12 Volt DC (VDC) Receptacles</b> .....	<b>65</b>
<b>USB Receptacles</b> .....	<b>65</b>
<b>Converter/Inverter</b> .....	<b>65</b>
<b>120 Volt (VAC) AC Receptacles</b> .....	<b>67</b>
<b>Ground-Fault-Circuit-Interrupt Receptacles</b> .....	<b>67</b>
<b>Pop-Up 110 Volt/USB Ports</b> .....	<b>68</b>
<b>Electrical Generator</b> .....	<b>68</b>
<b>Energy Management System</b> .....	<b>69</b>
<b>Electrical Power Cord Reel</b> .....	<b>69</b>
<b>Automatic Transfer Switch</b> .....	<b>70</b>
<b>Fuse Blocks</b> .....	<b>70</b>
<b>Seven-Pin Towing Connector</b> .....	<b>70</b>
<b>WIFI ANTENNA (OPTIONAL)</b> .....	<b>71</b>
<b>KING EXTENDED BOOSTER (OPTIONAL)</b> .....	<b>71</b>
<b>35CP</b> .....	<b>72</b>
<b>40IP</b> .....	<b>75</b>
<b>45FP</b> .....	<b>80</b>
<b>45FP</b> .....	<b>85</b>
<b>45OPP</b> .....	<b>88</b>
<b>10 Slide-Out Features</b> .....	<b>94</b>
<b>Slide-Out Overview</b> .....	<b>95</b>
<b>General Considerations</b> .....	<b>95</b>
<b>Operating Precautions</b> .....	<b>95</b>
<b>Extending the Slide-Out Room</b> .....	<b>96</b>
<b>Emergency Slide-Out Room Control Override</b> .....	<b>98</b>
<b>11 Exterior Features</b> .....	<b>99</b>
<b>Exterior Sides</b> .....	<b>100</b>
<b>Electric Slide Tray (Optional)</b> .....	<b>101</b>
<b>ELECTRIC SLIDE WITH KITCHEN (OPTIONAL)</b> .....	<b>101</b>
<b>Security Lights</b> .....	<b>101</b>
<b>Roof &amp; Ladder (Optional)</b> .....	<b>102</b>
<b>Electric Steps</b> .....	<b>103</b>
<b>Using the Electrical, Double-Entrance, Door Steps</b> .....	<b>103</b>

# TABLE OF CONTENTS

MIRRORS WITH BSM.....	106
Outside Refrigerator Access .....	107
<b>12 Interior Features.....</b>	<b>108</b>
Bedspread.....	109
ELEVATED BEDS CAUTION.....	109
Flooring.....	110
Safe.....	110
Rear Fireplace .....	110
Heated Tile Floor (Optional) .....	111
Ceiling.....	112
Ceiling Fan.....	112
WINDOW TREATMENT .....	113
Multiplex Lighting Control.....	113
Wall Sconce .....	114
<b>13 Plumbing &amp; Bath Features .....</b>	<b>115</b>
Tank-Level Monitor.....	116
Kitchen Sink .....	116
Bathroom Sink, Shower, & Accessories .....	117
Water Pump .....	117
City Water Connection.....	119
Filling the Freshwater Tank .....	119
Water Filter .....	120
Freshwater Lines.....	120
Sanitizing .....	121
Wastewater General Information .....	122
Toilet.....	122
Black-Water Holding Tank.....	123
Gray-Water Holding Tank .....	123
P-Traps.....	124
Wastewater Disposal.....	124
Sewer Connection and Camping .....	125
No Fuss Flush .....	125
Exterior Shower.....	126
Aqua-Hot Heating System .....	126
35CP .....	128
40IP .....	130
45FP.....	132
45OPP .....	133
45OPP .....	134



# TABLE OF CONTENTS

<b>14 Windows, Awnings, Vents, &amp; Doors .....</b>	<b>135</b>
<b>Windows.....</b>	<b>136</b>
<b>Awnings .....</b>	<b>136</b>
<b>Awning Remote Control .....</b>	<b>137</b>
<b>Vents.....</b>	<b>138</b>
<b>Doors.....</b>	<b>138</b>
<b>Keyless Lock .....</b>	<b>139</b>
<b>15 Driving Your Motorhome.....</b>	<b>140</b>
<b>Instrument Panel .....</b>	<b>141</b>
<b>Ecomaster Camera Monitor System.....</b>	<b>141</b>
<b>Basic Rear View Camera Operation .....</b>	<b>141</b>
<b>Side-Mount Camera .....</b>	<b>142</b>
<b>CB Radio System Antenna Connection .....</b>	<b>142</b>
<b>AM/FM/CD Stereo System .....</b>	<b>143</b>
<b>Dashboard Heating/Cooling Controls .....</b>	<b>143</b>
<b>Xcite Radio System (Optional) .....</b>	<b>143</b>
<b>Camera Monitoring System (Optional) .....</b>	<b>144</b>
<b>Secondary Passenger Monitor (Optional) .....</b>	<b>145</b>
<b>Levelling Zero-Set .....</b>	<b>145</b>
<b>Mobileye Collision Mitigation System .....</b>	<b>145</b>
<b>AFO Supplemental Braking System .....</b>	<b>146</b>
<b>Adaptive Cruise Control .....</b>	<b>146</b>
<b>16 Routine Maintenance .....</b>	<b>147</b>
<b>Washing .....</b>	<b>148</b>
<b>Seals .....</b>	<b>149</b>
<b>Proper Sealants for Application .....</b>	<b>149</b>
<b>Road Salt and Other Road Treatments .....</b>	<b>150</b>
<b>Wheel Care.....</b>	<b>150</b>
<b>Roof Care &amp; Maintenance .....</b>	<b>151</b>
<b>Moisture Management .....</b>	<b>151</b>
<b>Interior Care of Your RV .....</b>	<b>151</b>
<b>Control Relative Humidity .....</b>	<b>151</b>
<b>Avoid Drastic Thermostat Setbacks .....</b>	<b>152</b>
<b>Manage Window Condensation .....</b>	<b>152</b>
<b>Carpet Care and Moisture Management .....</b>	<b>152</b>
<b>Cleaning Tile and Wood Floors .....</b>	<b>152</b>
<b>Storage and Other Isolated Areas within the RV .....</b>	<b>152</b>
<b>Use of Un-Vented Combustion Equipment.....</b>	<b>153</b>
<b>Exterior Care of Your RV.....</b>	<b>153</b>

# TABLE OF CONTENTS

<b>Use of Your RV .....</b>	<b>153</b>
<b>Severe Environments .....</b>	<b>153</b>
<b>Storage of Your RV.....</b>	<b>153</b>
<b>Modifications to your RV.....</b>	<b>154</b>
<b>Wet Areas .....</b>	<b>154</b>
<b>Tire &amp; Safety Information.....</b>	<b>155</b>
<b>Section One .....</b>	<b>155</b>
<b>Section Two .....</b>	<b>164</b>
<b>Section Three .....</b>	<b>164</b>
<b>Tire Pressure .....</b>	<b>167</b>
<b>Interior Care .....</b>	<b>171</b>
<b>Fabrics .....</b>	<b>173</b>
<b>Walls &amp; Ceiling .....</b>	<b>174</b>
<b>Dashboard.....</b>	<b>174</b>
<b>Woodwork &amp; Floors .....</b>	<b>174</b>
<b>Countertops .....</b>	<b>175</b>
<b>Accessories .....</b>	<b>175</b>
<b>Detectors .....</b>	<b>176</b>
<b>Condensation.....</b>	<b>176</b>
<b>Routine Maintenance Schedules.....</b>	<b>177</b>
<b>Winterizing.....</b>	<b>178</b>
<b>De-Winterizing.....</b>	<b>179</b>
<b>17 Maintenance &amp; Data Charts .....</b>	<b>181</b>
<b>RV Owner Data Sheet.....</b>	<b>182</b>
<b>RV Owner Maintenance Record .....</b>	<b>183</b>

# ALLEGRO BUS

## GENERAL INFORMATION

---

Chapter

1



# ALLEGRO BUS

**WELCOME TO A LIFE OF “ROUGHING IT SMOOTHLY”**



**Tiffin Motor Homes – Made To Move You**

Tiffin Motor Homes is excited that you have entered the world of motorhome travel and we believe that you and your family will enjoy this way of life for years to come. Your Tiffin-built motorhome provides many of the comforts of home while allowing you to travel freely as you choose.



However, before heading out on the open roads, make yourself familiar with this owner's manual to learn more about the operations of your motorhome. Also, work with your dealer to learn as much as possible about the functionality and features of your coach.

In addition, remember, *“wherever you go, we go.”*

## **ABOUT THIS MANUAL**

Carefully read through this manual to understand how everything in your motorhome works.

---

**NOTE:** This operator's manual describes the features of your motorhome and includes instructions for their safe use. The manual, however, including its photography and illustrations, is of a general nature. Some equipment and features described in this manual might be optional or unavailable on your model.

The instructions included are meant to serve as a guide and in no way extend the responsibilities of Tiffin Motor Homes beyond the standard written warranty. The descriptions, illustrations, and specifications in this manual were correct at the time of printing and Tiffin Motor Homes reserves the right to change specifications or design without notice, and without incurring the obligation to install the same on products previously manufactured.

Many of the instruction sheets and manuals for the various appliances inside your motorhome have been incorporated into this manual for your convenience.

---

## GENERAL INFORMATION



# TIFFIN

## MOTORHOMES

### DELIVERY

Throughout the entire manufacturing process, your Tiffin motorhome has been regularly inspected by our qualified personnel to ensure that you receive the finest product of the highest quality. However, the final inspection at our factory is not the last one. The pre-delivery inspection and system check that your dealer perform are the final inspections before you receive your new motorhome. Your dealer is also available to assist you in understanding the warranties and completing the necessary forms to activate the warranties for the various appliances and accessories installed in your motorhome.

### DEALER RESPONSIBILITIES

1. A **pre-delivery inspection and systems check** is performed to ensure a thorough inspection of the motorhome and the proper operation of all factory-installed components.
2. A **customer walk-through** is performed to familiarize the buyer with the motorhome, its systems and components, and their proper and safe operation.
3. Delivery of the **Owner's Information Package**, which contains warranty cards and registrations for the vehicle and all factory-installed components from other vendors and suppliers to Tiffin Motor Homes. The detailed operation and maintenance instructions on these components are also included in this package.
4. Assisting the customer in **completing the registration forms** to avoid loss of warranty coverage. The dealer will review the limited-warranty provisions with the customer and stress the importance of completing the warranty cards and registration forms for the components in the motorhome to enable the manufacturers to receive them within the prescribed time limits.
5. Providing the customer with **information regarding warranty and non-warranty work** on the vehicle and its separately warranted components.

### CUSTOMER RESPONSIBILITIES

The customer is responsible for regular and proper maintenance of the motorhome. Properly maintaining your motorhome will prevent conditions arising from neglect that are not covered by your Tiffin Motor Homes limited warranty. The maintenance guidelines in this manual and any other

## GENERAL INFORMATION

applicable manuals must be followed. It is your responsibility and obligation to return the vehicle to an authorized dealer for repairs and service.

To assist you in avoiding problems with your motorhome, Tiffin Motor Homes recommends that you do the following:

1. **Read the warranty.** Go over it thoroughly with your dealer to make sure you understand all the terms and conditions of the warranty.
2. **Inspect the motorhome;** do not accept delivery until you have gone through the motorhome with the authorized Tiffin Motor Homes dealer.
3. **Ask questions** about anything you do not fully understand about your motorhome. Tiffin Motor Homes is here to serve you and ensure that you have all the information necessary for the safe and enjoyable use of your new motorhome.
4. When you are taking delivery, **set an appointment for adjustments.** This appointment must be within two weeks after you accept delivery.
5. You are responsible to **use your motorhome in a responsible, safe manner.** Take the time to familiarize yourself with the proper operation of the unit before you attempt to use it.

## REPORTING SAFETY DEFECTS (USA)

575.6(a)(2)(i) At the time a motor vehicle manufactured on or after September 1, 1990 is delivered to the first purchaser for purposes other than resale, the manufacturer shall provide to the purchaser, in writing in the English language and not less than 10 point type, the following statement in the owner's manual, or, if there is no owner's manual, on a one-page document:

**If you believe that your vehicle has a defect which could cause a crash or could cause injury or death, you should immediately inform the National Highway Traffic Safety Administration (NHTSA) in addition to notifying TIFFIN MOTOR HOMES.**

If NHTSA receives similar complaints, it may open an investigation, and if it finds that a safety defect exists in a group of vehicles, it may order a recall and remedy campaign. However, NHTSA cannot become involved in individual problems between you, your dealer, or Tiffin Motor Homes.

To contact NHTSA, you may either call the Vehicle Safety Hotline toll-free at 1-888-327-4236 (TTY: 1-800-424-9153); go to <http://www.safercar.gov>; or write to: Administrator, NHTSA, 1200 New Jersey Avenue, S.E., Washington, DC 20590. You can also obtain other information about motor vehicle safety from <http://www.safercar.gov>.

(ii) The manufacturer shall specify in the table of contents of the owner's manual the location of the statement in 575.6(a)(2)(i). The heading in the table of contents shall state "Reporting Safety Defects."

## REPORTING SAFETY DEFECTS (CANADA)

Vehicles domiciled in Canada that are thought to have a defect that could cause a crash, injury, or death, should immediately be reported to Transport Canada and Tiffin Motor Homes at 1-256-356-8661.



## GENERAL INFORMATION

If Transport Canada receives similar complaints, it may open an investigation; if it finds that a safety defect exists in a group of vehicles, it may order a recall and remedy campaign. However, Transport Canada cannot become involved in individual problems between you, your dealer, or Tiffin Motor Homes.

To contact Transport Canada, call the Defect Investigation and Recall Division toll-free in Canada at 1-800-333-0510 or 1-819-994-3328 in the Gatineau-Ottawa area or internationally.

By Mail:

Transport Canada – ASFAD

330 Sparks Street

Ottawa, ON

K1A0N5

### **Signalement Des Defauts De Securite A Transport Canada Pour Les Proprietaires Canadiens**

Si vous pensez que votre véhicule présente un défaut lié à la sécurité, vous devez immédiatement en informer Transports Canada (TC) ainsi que Tiffin Motor Homes, Inc.

Si Transports Canada reçoit des plaintes similaires, il pourrait ouvrir une enquête à ce sujet. Si le Ministère constate l'existence d'un défaut de sécurité au sein d'un groupe de véhicules, il pourrait ordonner une campagne de rappel et de réparation.

Toutefois, Transports Canada ne peut pas intervenir en cas des problèmes individuels entre vous, votre concessionnaire ou Tiffin Motor Homes, Inc.

Vous pouvez communiquer avec Transports Canada par l'un des moyens suivants:

Par telephone: 819-994-3328 (région de Gatineau-Ottawa ou international)

Numéros sans frais: 1-800-333-0510 (au Canada)

Par la poste:

Transports Canada – ASFAD

330, rue Sparks

Ottawa (Ontario)

K1A 0N5

Vous pouvez également consulter le site Web de Transports Canada à [tc.canada.ca](http://tc.canada.ca) pour remplir en ligne un formulaire de plainte de défauts.

## **TIFFIN MOTOR HOMES LIMITED WARRANTY**

The Tiffin Motor Homes limited warranty is provided to you by your authorized Tiffin Motor Homes dealer during the pre-delivery inspection. When you enquire about your Tiffin Motor Homes warranty, refer to this document. If you require an additional copy of the warranty or other information, contact:

Tiffin Motor Homes, Inc.

105 2nd St. NW • Red Bay, AL 35582

Phone: 256-356-8661

Email: [info@tiffinmotorhomes.com](mailto:info@tiffinmotorhomes.com)

## GENERAL INFORMATION

Visit [www.tiffinmotorhomes.com](http://www.tiffinmotorhomes.com) for access to related materials.

### MAJOR EQUIPMENT MANUFACTURERS

The following list is a compilation of the vendors and suppliers of the major subsystems and components of your motorhome. This list is provided for your convenience and is not a substitution of the literature accompanying the “how to contact us” information supplied by the vendors and suppliers in your Owner’s Information Package. Where appropriate, website information is also provided.

- |                              |                |  |
|------------------------------|----------------|--|
| • Atwood Mobile Products     | (800) 825 4328 | <a href="http://atwoodmobile.com">atwoodmobile.com</a>                   |
| • Aqua-Hot                   | (800) 685-4298 | <a href="http://aquahot.com">aquahot.com</a>                             |
| • Denso Corporation          | (800) 366 1123 | <a href="http://globaldenso.com">globaldenso.com</a>                     |
| • Flexsteel Industries       | (563) 556 7734 | <a href="mailto:service@flexsteel.com">service@flexsteel.com</a>         |
| • HWH Corporation            | (800) 494-3213 | <a href="http://hwhcorp.com">hwhcorp.com</a>                             |
| • Kwikkee                    | (541) 942-3888 | <a href="http://kwikkee.com">kwikkee.com</a>                             |
| • Norcold, Inc.              | (800) 543-1219 | <a href="http://norcold.com">norcold.com</a>                             |
| • Onan Corporation           | (256) 883-8164 | <a href="http://onanindiana.com">onanindiana.com</a>                     |
| • Power Gear                 | (800) 334-4712 | <a href="http://powergear.com">powergear.com</a>                         |
| • RV Products (Coleman A/C)  | (316) 832-3400 | <a href="http://airxcel.com">airxcel.com</a>                             |
| • Precision Circuits Inc.    | (630) 240-9832 | <a href="http://precisioncircuitsinc.com">precisioncircuitsinc.com</a>   |
| • Saf-T-Alert (CO/LP Alarm)  | (800) 383-0269 | <a href="http://safetalert.com">safetalert.com</a>                       |
| • Sharp Corporation          | (800) 237-4277 | <a href="http://sharp-usa.com">sharp-usa.com</a>                         |
| • Suburban Manufacturing Co. | (423) 775-2131 | <a href="http://suburbanmanufacturing.com">suburbanmanufacturing.com</a> |
| • The Dometic Corporation    | (219) 294-2017 | <a href="http://dometic.com">dometic.com</a>                             |
| • Whirlpool                  | (800) 749 7929 | <a href="http://whirlpool.com">whirlpool.com</a>                         |
| • Winegard                   | (800) 288 8094 | <a href="mailto:help@winegard.com">help@winegard.com</a>                 |
| • LG                         | (800) 243-0000 | <a href="http://lg.com">lg.com</a>                                       |

### WARRANTY SERVICE

All warranty service needs to be completed during the warranty period (basic warranty: 12 months or 12,000 miles). Tiffin Motor Homes warrants its unitized construction for 10 years and its laminations for five years. Any service work performed after the expiration of the Tiffin Motor Homes warranties **WILL NOT** be covered by those warranties.

Exceptions may be made, on an individual basis, to this deadline, because of the unavailability of parts and/or service appointment time where work is to be performed. However, do not rely on the possibility of an exception; schedule any desired in-warranty work before your warranty expires.

# GENERAL INFORMATION

## OWNER'S INFORMATION PACKAGE

The Owner's Information Package includes valuable documents about your motorhome and its components and systems. By consulting the booklets and instruction manuals included in the Owner's Information Package, you will learn how to operate, maintain, and troubleshoot these items safely and effectively. The Tiffin Motor Homes Owner's Manual does not cover every possible detail of equipment—standard and/or optional—installed on or in your vehicle.

As with all valuable documentation, keep them in a safe, secure place for your later use and consultation. When you complete and mail to the respective manufacturers any warranty/guaranty registration cards, make a photocopy of both sides of each card before mailing, and keep the photo copy in your permanent records for your motorhome.

## CUSTOMER RELATIONS

To schedule maintenance or service, or order parts, notify your local authorized Tiffin Motor Homes dealership to set up an appointment. If you are unsure of the location of your nearest authorized Tiffin Motor Homes dealership, access the Tiffin Motor Homes website at [www.tiffinmotorhomes.com](http://www.tiffinmotorhomes.com), and then click on the "Locate Dealer" button, and then enter the appropriate search criteria, such as state and retail sales, and then click on the red ball located on the map to find dealer information in that area.

## SPECIFICATION LABELS

There are two main numbers used to identify your motorhome. The Vehicle Identification Number (VIN) is the legal identification of the vehicle. The VIN is the number used by the state for vehicle identification and registration. Additionally, there is a Tiffin serial number ( ). This number can be found on the side of the dashboard. A typical sample of this identification label is shown below.



Figure 1-1: RVIA Label located on the outside of the motorhome

MANUFACTURED BY:	TIFFIN MOTOR HOMES INC		DATE:	4/18/2014	
GVWR	10669	KG( 23500 LB)			
GAWR FRONT	3859	KG( 8500 LB)	TIRES	26570R19.5	RIMS 19.5X8.25
				110	PSI
GAWR INTERM		COLD INFLATION PRESSURE	LB) TIRES		RIMS
		KG(		KPA(	PSI
GAWR REAR	6810	KG( 15000 LB)	TIRES	26570R19.5	RIMS 19.5X8.25
				110	PSI
		COLD INFLATION PRESSURE	758	KPA(	
THIS VEHICLE CONFORMS TO ALL APPLICABLE FEDERAL MOTOR VEHICLE SAFETY STANDARDS IN EFFECT ON 4/2014					
V.I.N	5VBR093A4EA115569			TYPE:	MPV



## GENERAL INFORMATION

# NOTICE

**NOTICE is used to address practices not related to personal injury, or damage to the equipment.**

## WEIGHING PROCEDURES

To weigh the motorhome properly, the motorhome must be level when the weighing process is performed. Your motorhome has been designed and built in compliance with the recommended limits of the major-component/system suppliers to provide a

realistic OCCC. It is up to the final user to provide even distribution to prevent uneven loading. Once the vehicle is loaded, it can be taken to any certified drive-on scales or individual-wheel scales to determine that the final weight is within specified limits for the motorhome.

### To Determine the Final Weight of the Motorhome:

1. Drive the motorhome onto the scales so that all wheels are on the scales; this provides the gross vehicle weight (GVW) of the vehicle and can be recorded as such. The GVW must not exceed the GVWR specified for the vehicle.
2. Drive the motorhome so that only the rear wheels remain on the scales; this provides the total weight of the vehicle, save for the front axle. This weight must not exceed the total rating of the axles remaining on the scales. The front axle weight is determined by subtracting the weight from the GVW that was obtained in the first step. The result must not exceed the listed front-axle weight rating.

## WEIGHT DISTRIBUTION

To ensure the maximum stability of the motorhome under static (i.e., parked) and dynamic (i.e., moving) conditions, the distribution of the items to be carried and stored within the motorhome and in the storage bays underneath the motorhome must be performed in such a manner as to strive for reasonably even side-to-side and front-to-rear dispersion of the weight of the stored items. This process will ensure that the motorhome is not “lop-sided” in weight distribution (i.e., all the stored weight is not on one side and/or mainly toward the front or the rear). Keeping a center of mass of the motorhome essentially centered on a front-to-rear and side-to-side basis will also provide better control of the motorhome when it is in motion.

## SAFETY MESSAGES

Note that several labels listed in this manual represent items that need your attention. The Danger, Warning, Caution, and Notice labels alert you to precautions that might help you to avoid damage to your motorhome, its equipment, or your personal safety. Read and follow them carefully.

## GENERAL INFORMATION



**WARNING**

WARNING indicates a hazardous situation, which, if not avoided, could result in death or serious personal injury, or damage to the equipment.



**DANGER**

DANGER indicates a hazardous situation, which, if not avoided, will result in death or serious personal injury, and damage to the equipment.



**CAUTION**

CAUTION indicates a hazardous situation, which, if not avoided, could result in minor or moderate personal injury, or damage to the equipment.



# ALLEGRO BUS

## SAFETY INSTRUCTIONS

---

Chapter

2

# SAFETY

## SAFETY CONSIDERATIONS

Before using your motorhome, especially for the first time or after a long period of non-use, read all the instructions in the Owner's Manual and the chassis-manufacturer's manual thoroughly. There are several safety considerations that you must be aware of and follow while your motorhome is in motion. These safety considerations, as well as others meant to preclude any damage to the motorhome, are listed in this chapter. Besides the driver, it would be helpful for the passengers to be familiar with these safety considerations and precautions too.

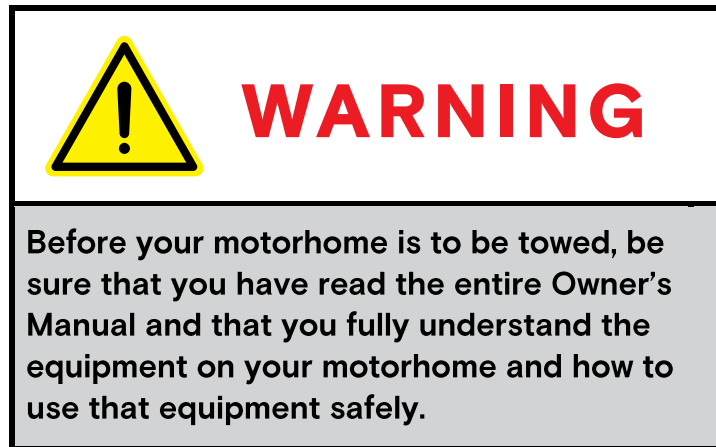

## GENERAL WARNINGS

In general, there are several "common-sense" safety precautions that must be taken every time the motorhome is to be used on the road. These precautions include:

- Only seats with seat belts must be used while the motorhome is in motion; the seat belts should be worn by all people (driver and passengers) in the motorhome at that time.
- While the motorhome is moving, lock all seats in the forward-facing position to provide maximum safety for the users.
- While the motorhome is moving, no one (e.g., young children) inside should ever stand or kneel on the seats.
- In the majority of states, it is the law that seat belts must be used (fastened snugly about the chest and hip areas), anytime the motorhome is in motion, to provide desired protection in the event of a crash.
- Any fire extinguishers must be inspected on a monthly basis to ensure that each extinguisher is properly charged and ready for operation.
- Any smoke and/or carbon-monoxide (CO)/liquid propane (LP) alarms must be regularly inspected and tested. If being used for the first time, the smoke and/or CO/LP alarm must be properly activated and fresh batteries installed before the motorhome is placed into service. Never sleep in a motorhome not having functional smoke and/or CO/LP alarms.
- While the motorhome is moving, the sleeping facilities are not to be used.

## SAFETY

- Be sure to be familiar with all emergency exits (doors, emergency window). Do not use the emergency window as a routine exit; this is strictly to be used for emergency purposes only.
- Movement inside the motorhome should be minimized while the motorhome is in motion.
- Never leave the driver's seat unattended while the motorhome is in motion.

## PRE-DEPARTURE CHECKLIST

For your continued safety and convenience, the following is a representative "checklist" designed to ensure your safety while driving:

- ✓ Clean all windows, mirrors, and light lenses (front, back, and sides) to ensure that you can "see" and "be seen."
- ✓ Reposition any mirrors or other fixtures to provide an unobstructed view (front, back, and sides) from the driver's seat.
- ✓ Remove or secure all loose fixtures (e.g., awnings, flags, antennas, portable lights) to keep them from falling from the motorhome when the vehicle is in motion.
- ✓ Make a "walk-around" visual inspection of the motorhome to note any irregularities (e.g., loose trim) or problems (e.g., low tires); correct noted problems accordingly.
- ✓ Check all exterior storage-compartment and generator-compartment doors to make sure that they are properly latched. If need be, check inside all exterior compartments to make sure that all cargo and equipment are properly secured so that they do not work loose and become hazards during sudden starts and stops.
- ✓ Check the tires for proper inflation (i.e., cold-inflation pressure: 100 psig). If the motorhome has not been used, make sure that the "cold-inflation" pressure is maintained. If the motorhome has recently been used, make sure that the "hot inflation" pressure (see the tire-manufacturer's literature to determine appropriate "hot inflation" pressure) is maintained. All tire pressures must be within 1-2 pounds (psi) of each other.
- ✓ Examine wheel lug nuts to ensure their proper tightness. If any lug nuts are found to be loose, first check the fit of the wheel to the hub to make sure the wheel is mounted properly, which would produce a "wobbly" wheel when the motorhome is in motion, and then tighten the lug nuts.
- ✓ Check all fluid levels (e.g., engine oil, transmission fluid, coolant, power-steering fluid, brake fluid, battery fluid [if applicable], windshield-washer solvent) to ensure that correct levels are maintained. Fill any low reservoirs, as needed.
- ✓ DO NOT SUBSTITUTE any other fluids for specified oils, transmission fluid, brake fluid, or other hydraulic fluids—substitutions are not acceptable and can void warranties.



## SAFETY

- ✓ Before starting the motorhome engine, make sure all lines (e.g., water, sewer) and electrical power cords are disconnected and properly stowed.
- ✓ Ensure that the leveling jacks are in the “travel” position and antennas are securely docked.
- ✓ After entering the motorhome, make sure that the electrically actuated, retractable step has properly operated to retract the step fully before starting the engine of the motorhome.
- ✓ Check all interior doors (e.g., shower, microwave, refrigerator, etc.) to ensure that they are locked and/or secure. Make sure that all large items are stored away and secure (e.g., coffee pots, corning ware, etc.).

## DRIVING SAFETY

Various adjustments must be made to ensure the driver’s comfort and the safety of the motorhome before starting and moving the motorhome; these include:

- Do not attempt to adjust the driver’s seat while the vehicle is moving.
- Do not adjust the tilt steering while the vehicle is moving.
- The driver must be familiar with all gauges, instruments, switches, and indicators on the instrument panel before driving.
- Do not operate the cruise-control function during any extreme weather situations (e.g., snow, ice, sleet, heavy rain), when road conditions are hazardous (icy, snowy, winding roads, city traffic), when a constant speed of the motorhome is not possible, or if traffic conditions do not warrant such.
- Avoid driving the motorhome through any standing water. If deep enough, such water can wet the brake pads and cause fading of the brakes (i.e., loss of braking power) and lead to excessive sliding or pulling to one side or the other.
- Know the limits of operation of the motorhome. Do not try to achieve excessive speeds, climb overly steep hills, traverse overly long grades, attempt to use as an “off-the-road” (OTR), rapidly switch lanes, or rapidly accelerate or decelerate the motorhome. When in doubt about the handling characteristics of the motorhome, consult your chassis manual for information.
- The solar or blackout shade is operated by using a switch on the driver’s console. Depress the switch to lower or raise the shade. On the Allegro Bus, the switch is labeled SOLAR SHADE or NIGHT SHADE. The time delay switch must be held for a few seconds before it is activated.



Figure 2-1: Driver’s Side Dashboard and Instrument Console

## SAFETY

- NEVER drive the vehicle with a slide-out room extended.



## FUELS FOR THE MOTORHOME

Your Allegro Bus is designed to use diesel fuel only:

- Anytime the motor fuel is to be filled, turn OFF the motorhome engine, all pilot lights, and appliances.
- DO NOT SMOKE when refilling the fuel tank.
- NEVER use any other “burning” equipment (e.g., charcoal grills, wood stoves, butane lights, propane lights) inside the motorhome. Doing so might cause fires and/or asphyxiation.

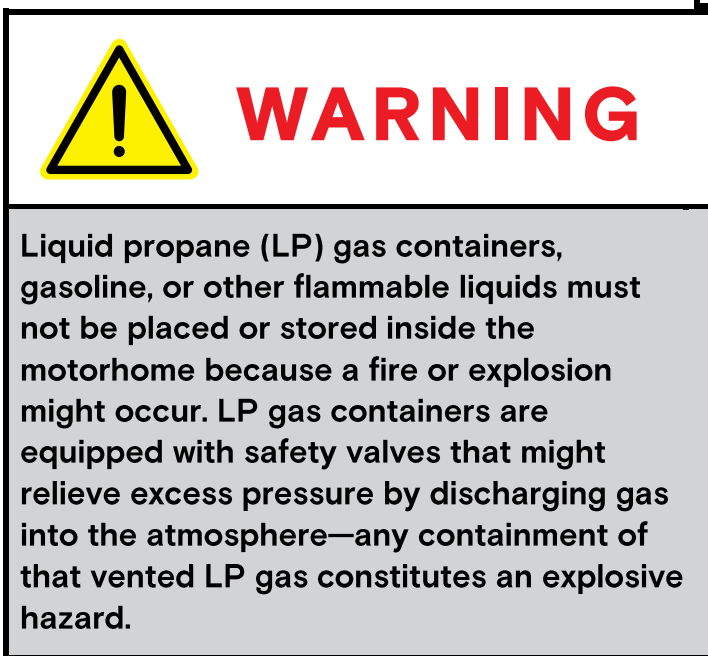

## SAFETY

### CARBON MONOXIDE WARNING

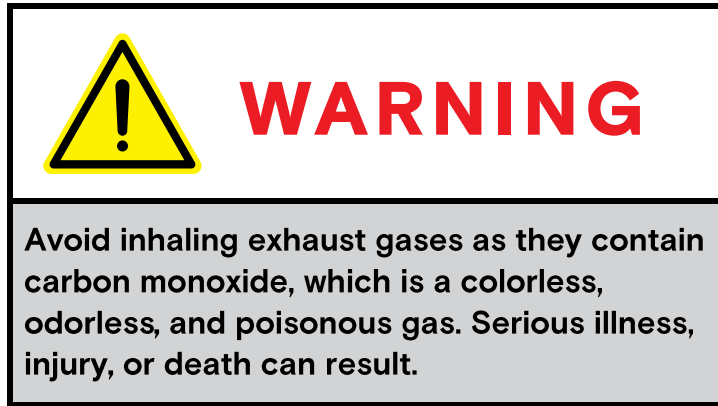

A properly maintained engine exhaust and ventilation system is the best way to protect against carbon monoxide's entry into the vehicle. Tiffin Motor Homes recommends that the exhaust system and body be inspected by a qualified motorhome service center:

- Each time the vehicle is serviced for an oil change.
- Whenever a change in the sound of the exhaust system is noticed.
- Whenever the exhaust system, underbody, or rear of the vehicle is damaged.

To allow proper operation of the vehicle's ventilation system, keep the front ventilation inlet grill clear of obstructions at all times.

Do not occupy a parked vehicle with the engine running for an extended time, and do not run the engine in confined areas, such as a garage.

Your motorhome is equipped with a combination CO/LP Gas Alarm (Figure 2-2). This alarm combines a single compact system that detects both Carbon Monoxide (CO) and Propane (LPG) gas. It will detect carbon monoxide gas from any combustion source such as the furnace, oven/range, water heater, refrigerator, chassis engine, and generator engine.

### CO/LP GAS DETECTOR

Since LP gas is denser than air, the LP gas will naturally settle to the lowest point in an enclosed space. In the motorhome, this would be the floor. Because of this, the CO/LP gas detector (Figure 2-2) is necessarily mounted close to the floor.

To activate the CO/LP-gas sensor on this detector for the first time, remove the sensor activation strip, if it was not removed during the pre-delivery inspection.

If the alarm persists in re-arming and giving further alarms, ventilate the motorhome by opening the doors and windows. After the ventilation process is concluded, shut all the doors and

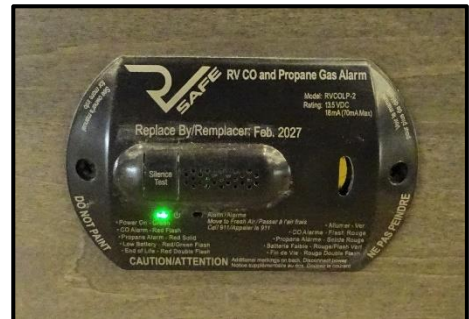

Figure 2-2: Carbon Monoxide/LP Gas Detector



## SAFETY

windows, and then take the motorhome to a qualified service technician.

The CO/LP gas detector is a single compact system that provides a powerful combined alarm that detects both Carbon Monoxide (CO) and explosive gases, such as Propane (LPG) and Methane (Natural Gas). This detector uses the latest microprocessor technology combined with two electronic self-cleaning sensors that operate independently of each other. The combined unit can detect both CO and explosive gases simultaneously.

Carbon monoxide (CO) is a colorless, odorless, tasteless gas which, when breathed, bonds to the hemoglobin in the red blood cells and, thus, drastically reduces or blocks the transfer of oxygen from the lungs to the rest of the body.

In sufficient concentrations, CO kills by asphyxiation. In lesser amounts, CO makes the victim groggy, lethargic, and unable to think clearly or quickly.

CO is one of the products of combustion for many materials including petroleum-based products (e.g., gasoline, diesel fuel, propane, butane, etc.). Since many of the appliances and the engines associated with the motorhome produce CO in their normal operations, it is necessary to ensure that CO levels do not rise to dangerous levels within the motorhome. In sufficiently high concentrations, CO can kill in minutes.

The people most susceptible to CO poisoning are unborn babies, small children, pregnant women, senior citizens, and people with cardiovascular or respiratory problems.

Consequently, it is prudent to check the CO monitor regularly for normal operation and to remain aware of the symptoms of CO poisoning, which include dizziness, nausea, vomiting, muscular twitching, throbbing in the temples, incoherent thinking and speech, weakness, sleepiness, and intense headaches.

If any of these symptoms are experienced in the motorhome, IMMEDIATELY evacuate the motorhome and seek medical help. Shut down the motorhome and do not attempt to operate it again until the sources of the CO are located and fixed.



## DANGER

**Carbon monoxide gas—derived from products of combustion of diesel fuel, LP gas, and other petroleum-based products—is a deadly gas that can kill motorhome occupants, if allowed to accumulate in sufficient concentration. Ensure that all engine operations are not restricted—tailpipes and exhaust ports should not be blocked or restricted in any way. Additionally, any accumulation of exhaust gases outside or underneath the vehicle must be avoided as it might enter the motorhome through windows or vents—be careful of how and where the motorhome is parked to avoid such conditions. Regularly monitor outside conditions to ensure that all exhaust gases can readily be dissipated and not enter the motorhome inadvertently.**

## SAFETY



# DANGER

Never sleep in a motorhome when the engine is running—engine exhaust fumes could enter the motorhome and cause disability or death. Regularly check the exhaust system to note any leakage sites and, if found, discontinue use of the motorhome until they are repaired by a competent, qualified service technician. Do not attempt repairs on the exhaust system yourself and do not modify (temporarily or permanently) the exhaust system at all.

## FIRE SAFETY

As with any enclosed system containing the three required conditions for fire (i.e., combustible materials, oxygen, and ignition sources), there will exist the possibility of fire inside the motorhome. Tiffin Motor Homes has taken every precaution and design practice to minimize or negate this possibility, but the final determination rests with the owner and user of the motorhome. Hence, the owners, users, and their guests must be aware of basic fire-safety practices and procedures, and those particular features that Tiffin Motor Homes has provided for fire safety.

## FIRE EXTINGUISHER

The motorhome is equipped with a fire extinguisher located in the entrance door stairwell (Figure 2-3). The extinguisher is rated for both Class B (i.e., grease, gasoline, diesel fuel, flammable liquids) and Class C (i.e., electrical) services.

Read and understand the accompanying owner's manual on the extinguisher (found in your Owner's Information Package) and remember the location of the extinguisher. These types of fire extinguishers are pressurized mechanical devices and require that appropriate care be used in their safe storage and use. The owner's manual will provide necessary guidance for the proper storage, handling, and use of the extinguishers.

Prudent preventive maintenance suggests monthly inspection of any fire extinguisher to ensure that it is sufficiently pressurized (i.e., the needle on the gauge is in the "normal" zone) and that the mechanical components are not blocked in any way.



Figure 2-3:  
Fire Extinguisher

## SAFETY

**DO NOT test a fire extinguisher by partially discharging the unit**—this will cause a loss of pressure and might lodge some fire-retardant materials in the valve mechanism and cause the extinguisher to continue to vent slowly down to zero pressure. If an extinguisher is ever partially used, continue its use until the unit is completely discharged. Then, have the fire extinguisher fully recharged at an appropriate service center (call any fire department for information on having an extinguisher recharged in that particular locality).

**DO NOT wait to recharge an empty fire extinguisher;** you will never know when it might be needed.

Should a fire occur inside or around the motorhome, evacuate the motorhome quickly and calmly—do not panic. In the event of heavy smoke or extensive flames, keep low (crawl if you must), and make your way to the nearest exit (door, emergency window) and leave. If the fire involves a fuel source (e.g., diesel fuel, LP gas), consider the probability of an explosion and move sufficiently far away to minimize personal harm. If possible, immediately place a call to the local fire department (or ask someone nearby to do so) to report the fire. Consider the cause and the consequences of the fire and the risks associated with possibly fighting the fire yourself before trying to extinguish it.

**DO NOT expose yourself or others to unnecessary danger.**

## SMOKE DETECTOR

The motorhome is equipped with a battery-operated smoke detector (Figure 2-4) located on the ceiling in the living area of the motorhome.

The smoke detector must be tested on a weekly basis, before each trip, and after any period of storage of the motorhome.

If a low-battery condition is noted or the alarm “chirps” to indicate a low-battery condition, immediately replace the battery. Tiffin Motor Homes recommends that you keep replacement batteries in the motorhome for any in-transit replacements so that the smoke-alarm capability is never compromised.



Figure 2-4: Smoke Detector

**DO NOT disable the smoke detector** for any transient, false alarm (e.g., cooking smoke, dusty furnace, tobacco smoke). Ventilate the motorhome with fresh air and the alarm will reset on its own.

## ELECTRICAL

- Careless handling of electrical components can be fatal. Never touch or use electrical components or appliances while feet are bare, hands are wet, or standing in water.
- Improper grounding of the vehicle can cause personal injury.
- Do not attach an extension cord to the utility power cord.
- Do not use any electrical device that has had the ground pin removed.
- Avoid overloading electrical circuits. Replace fuses or circuit breakers with those of the same size and amperage rating only. NEVER use a higher rated fuse or breaker.

# SAFETY

## LOADING

- Store or secure all loose items inside the motorhome before traveling. Possible overlooked items such as canned goods or small appliances on the countertop, cooking pans on the range, or freestanding furniture can become dangerous projectiles during a sudden stop.
- Be aware of GVWR, GAWR, and individual load limit on each tire or set of duals.
- Never load the motorhome in excess of the gross vehicle weight rating or the gross axle weight rating for either axle.

## MAINTENANCE

- Do not remove the radiator cap while the engine and radiator are still hot. Always check the coolant level visually using the see-through coolant reservoir.
- NEVER get beneath a vehicle that is held up by a jack only.
- Do not mix different construction types of tires on the vehicle. Replace tires with the exact size, type, and load range.

## EMERGENCY EXITS

The living areas of the motorhome are equipped with emergency exit windows (Figure 2-5 and Figure 2-6). These windows are designed for emergency exits when it is not practical to exit by the door, which also is an emergency exit—in the front of the motorhome. These windows are readily noticeable by their red handles and the red EXIT label on the windows.



Figure 2-5: Emergency Exit Window



Figure 2-6: Emergency Exit Latch

To use these windows as emergency exits, lift the handle and push outward on the window. As required, the window can be closed by pulling the window inward and then lowering the handle to latch the window back in place. When the motorhome is to be parked, note where these windows will be, so that the exits will not be blocked (e.g., against a tree, pole, or wall).

## SAFETY

### PARKING PROCEDURES

To park the motorhome in any unfamiliar terrain, examine the site for surface irregularities, slopes, or inclines, and other items such as stumps, rocks, or external connections for power/water/sewage, and also examine the area immediately above the parking site for obstructions like tree branches and limbs, signs, and overhead wiring.

If the motorhome is to be backed into the parking site, try to have that site on the driver's left-hand side, as this will allow the driver to watch the rear of the motorhome. Back up slowly and use the side mirrors and the back-up camera as a guide or, better yet, have another person outside provide guidance to help park the motorhome.

When the motorhome is finally situated, shift the transmission into park, set the foot-operated park brake, and then turn OFF the engine. Activate the hydraulic levelling system to level and stabilize the motorhome.

If the motorhome is to be powered externally, connect the 120 VAC power to the motorhome. If the motorhome uses LP gas, turn ON the LP gas valve at the LP tank. Connect the fresh-water supply and sanitize the water systems as needed. Connect the waste drain hose to the external sewer hook-up. Start the refrigerator, water heater, and furnace, as warranted. Light the oven pilot light, as needed. Certain appliances, such as the refrigerator, will not work properly, if the motorhome is not level, so be sure to complete the motorhome-levelling process before activating any of the appliances.

### TOWING HITCH

The motorhome is fully capable of towing typical motor vehicles.

On the rear of the Allegro Bus is a towing hitch (Figure 2-7) capable of handling a tongue weight of 1,500 lbs. A 20,000 pound hitch is also available with the 605 HP engine upgrade. Units with a tag axle have a 15,000-pound towing limit and those units without a tax axle have a 10,000-pound towing limit.

The towing hitch features a standard 7 pin wiring connector. If desired, a trailer brake actuator can be added. The plug for the actuator is located to the left of the steering column, underneath the dash.



Figure 2-7: Towing Hitch & Tow Brake Air Outlet

A tow brake air outlet is also available for use with an **Air Force One Supplemental Braking** system.

The motorhome is capable of towing light loads, and instructions are in the chassis manufacturer's literature in the Owner's Information Package provided with the motorhome.

The total weight of the motorhome and any vehicle towed by that motorhome must not exceed the Gross Combined Weight Rating (GCWR).

## **SAFETY**

The tongue weight must not exceed 10 percent of the towing capacity. Information related to the motorhome weight and GCWR can be found on a sticker inside the motorhome closet. Any vehicles to be towed by the motorhome must have adequate active braking.

**Tiffin Motor Homes does not recommend using any type of hydraulic towing lift that attaches to the rear of the motorhome designed to carry motorcycles, scooters, golf carts, etc.**

**NOTICE. If drop hitch or receiver extension is added to coach, it reduces ton capacity by half.**



The tongue weight must not exceed 10 percent of the towing capacity. Information related to the motorhome weight and GCWR can be found on a sticker inside the motorhome closet. Any vehicles to be towed by the motorhome must have adequate active braking.

**Tiffin Motor Homes does not recommend using any type of hydraulic towing lift that attaches to the rear of the motorhome designed to carry motorcycles, scooters, golf carts, etc**



# **ALLEGRO BUS**

## **SPYDER CONTROLS SYSTEM**

---

Chapter

3

# SPYDER CONTROLS SYSTEM

## SPYDER CONTROLS SYSTEM



Figure 3-1: Spyder Controls Multiplex System

The Master Control Screen houses the **Spyder Controls Multiplex System** (Figure 3-1). This electronic command center has an easy-to-read touchpad screen that enables you to control features throughout the coach. In addition to showing you the fresh water, grey and black tank levels, the inside and outside temperatures, and the house and chassis battery voltage, you can control almost every electronic feature on your coach from here.

Push the first button, the HOME button (Figure 3-2), to view your tank levels, the temperatures for all three zones of your coach, as well as the outside temperature, and your battery voltage. You can also control the on/off switches for the heated floors, gas, and electric water heaters powered by your Aqua-Hot system, your generator, and your inverter.



Figure 3-2: Home Screen for the Spyder Controls System

For detailed instructions and videos on the Spyder Controls system, visit [www.spydercontrols.com](http://www.spydercontrols.com) (Figure 3-3).

Click on the Customers tab at the top.

To access text and audio files, use the following information:

Username: Tiffin

Password: Motor Homes

---

**NOTE:** Both username and password are case sensitive.

---



Figure 3-3: Spyder Controls Website Home Screen

# **ALLEGRO BUS**

## **HEATING & AIR CONDITIONING**

---

Chapter

**4**

## HEATING & AIR CONDITIONING

### AQUA-HOT HEATING SYSTEM

The Allegro Bus features an Aqua-Hot heating system (Figure 4-1) that provides a continuous, on-demand supply of domestic hot water, as well as interior zone.

Both heating features are accompanied by a unique VDC-powered diesel-fired burner, and a VAC-powered electric heating element (120 VAC). These two heating sources maintain the temperature of the Aqua-Hot's solution of water and anti-freeze.

If interior heat and hot water are both needed at the same time, the hot water will take precedence over the interior heat, causing the interior heat to shut down and turn off until the water flow is turned off from the water sources.



Figure 4-1: Aqua-Hot Heating System Control Screen



Figure 4-2: Aqua-Hot Surge Tank

In the Allegro Bus, the controls for the Aqua-Hot heating system are integrated with the Spyder Controls System. To activate the Aqua-Hot heating system, select the Aqua-Hot option from the Spyder Controls System home screen. By activating this function, a supply of hot water as well as interior heat can be provided. The surge tank (Figure 4-1), which is located in the basement, must be routinely inspected to make sure the anti-freeze fill line stays in the acceptable zone. If the anti-freeze becomes low, you must add the recommended anti-freeze stated in the Aqua-Hot owner's manual.

If anti-freeze is totally depleted from the surge tank, a switch will be released inside the main Aqua-Hot tank, disabling the system from operating. Anti-freeze will then have to be added to the tank to reactivate the switch and allow the system to operate. If batteries become discharged and the Aqua-Hot system is activated, the system will automatically shut down before the batteries are totally discharged. Once power is restored to the batteries, the system must be reset by depressing the reset button on the black panel of the surge tank. For detailed operations on using the heating system, refer to the owner's manual in your Tiffin Owner's Information Package.

## NOTICE

**Yearly maintenance is required on the burner portion of the Aqua-Hot heating system.**

## HEATING & AIR CONDITIONING



### CAUTION

The Aqua-Hot heating system operates off the motorhome's diesel tank. The Aqua-Hot fuel tube is located higher in the diesel tank than the motorhome's engine fuel in order to prevent complete depletion of the diesel fuel tank. **BE SURE AN ADEQUATE AMOUNT OF FUEL IS IN THE TANK BEFORE DRY CAMPING.**



### CAUTION

**DO NOT** operate the diesel burner and/or the electric heating element without the water and anti-freeze solution in the Aqua-Hot's boiler tank. Failure to do so will cause **SERIOUS DAMAGE** to the heater.

## AIR CONDITIONING SYSTEM

The factory-installed air-conditioning system is designed for 120 VAC power supplied either from the external power cord or from the generator. For the best cooling scenarios, park the motorhome in a shaded location whenever possible and close drapes on the windows exposed to direct sunlight.

The air-conditioned, cooled air is emitted through the vents (Figure 4-3 to Figure 4-5), which are located in the roof throughout the entire coach along the passenger side. The return air vents run parallel, front to back, on the ceiling along the driver's side of the coach. The return vents are similar to the air conditioning vents, but they contain foam filters that keep dust from flowing back through the air conditioning system. The return filters can be easily removed and cleaned with warm water and a mild cleaning solution. To remove the filter, pull the vent down and lift the filter from inside the opening.

## HEATING & AIR CONDITIONING



Figure 4-3: Ceiling Vents



Figure 4-4: Traditional Ceiling Layout



Figure 4-5: Contemporary Ceiling Layout

### NOTICE

**The air conditioning system is the major consumption device of electrical power in the motorhome. When this system is being used in an RV park, cumulative use of these air-conditioning systems by the resident vehicles can create a bigger demand for electrical power than is actually available. Accordingly, at times, a “brown-out” condition might arise. This is when the AC voltage normally available drops to a lesser value (e.g., 10-20% below normal or more).**

**“Brown-out” conditions cause appliances to draw greater currents to make up for the reduced voltage; thereby causing circuit breakers to trip or fuses to blow. Under such conditions, your own motorhome is not at fault; reset your breakers and/or replace your fuses. Should such conditions continue, reduce the electrical load (in this case, turn OFF the air conditioning system for a while) or start the electrical generator.**

### AIR CONDITIONING CONTROLS

The following is a brief overview of how best to operate the air conditioning (A/C) controls. The A/C controls are integrated into the Spyder Controls Multiplexing System, and can be found on any of the touch screens. To access the A/C controls, touch the temperature icon located on the 10” touch panel in the hallway, or use one of the 7” or 5” touch panels. These are located throughout the coach. To activate the desired A/C, select A/C on the touch panel. Once pressed, the A/C button will begin flashing. The right side of each A/C control panel will indicate the fan speed (HIGH, LOW, or AUTO). The default setting for the fan speed is AUTO. This can be changed by pressing LOW or HIGH. When the A/C is in the AUTO mode, a fan icon below the arrows will indicate the fan speed. In AUTO mode, once the temperature reaches the set point, the compressor (indicated by a blue snowflake changing to gray) will cut off first, and then the fan will shut off after. If the fan speed of HIGH or LOW is selected, the compressor will shut off, but the fan will stay on when the set point for temperature has been reached.



## HEATING & AIR CONDITIONING

---

**NOTE:** If the motorhome temporarily loses its 110V power, the air conditioning system will resume operation at its last programmed setting when power is restored. If 12V power is lost, the thermostat settings will turn off, and the climate control must be turned back on.

---

---

**NOTE:** The A/C and heater cannot operate at the same time.

---

### THERMOSTAT ON SPYDER CONTROLS SYSTEM

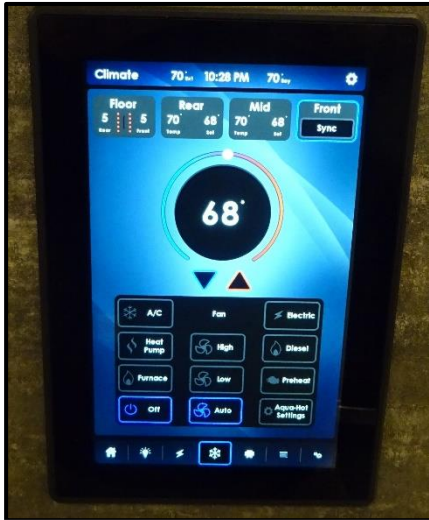

Figure 4-6: A/C Thermostat Control on 5-inch Panel

The following is an overview of how best to use the thermostat on the Spyder Controls System (Figure 4-6). For more detailed instructions, refer to the thermostat literature in the Owner's Information Package.

1. Push the THERMOMETER icon on the Spyder Controls System. This will bring up a touch screen to select the desired function (e.g., A/C, HEAT PUMP, FURN, or OFF).

---

**NOTE:** In the A/C mode, there will be a delay of several minutes before the refrigerant in the air-conditioning system begins to cool the motorhome, as the compressor is on a time delay circuit and it must also cool the ductwork to the vents first.

---

2. Select the Fan Mode operation (AUTO) or set the Fan Speed operation (LOW or HIGH) to select the fan speed desired.
3. Press the UP and/or the DOWN buttons to set the desired temperature for the motorhome.

---

**NOTE:** When the fan is on AUTO mode, the fan will turn on and off when the temperature reaches the desired setting.

When the fan is on LOW or HIGH mode, it will continue to run even though the compressor cycles on and off when it reaches the desired temperature.

If the motorhome temporarily loses its 110V power, the air conditioning system will resume operation at its last programmed setting once power is restored.

If 12V power is lost to the thermostat, it will automatically reset to 72 degrees once power is restored.

---

---

**NOTE:** There is a thermostat control for each air conditioning unit.

---

# HEATING & AIR CONDITIONING

## HEAT PUMP CONTROLS

To activate the optional heat pump (Figure 4-7), set the thermostat to the ELEC HEAT mode and select the desired temperature.

---

**NOTE:** If the setting on the thermostat and the room temperature are more than five degrees apart, the Aqua-Hot heating system will automatically turn ON with the heat pump. Once the room temperature reaches the desired level specified on the thermostat setting, the furnace will cut off and the heat pump will maintain the heating of the coach.

---

---

**NOTE:** The heat pump is controlled by each individual thermostat.

---

If the external temperature falls to 45 degrees Fahrenheit, the heat pump will become inoperative and the gas furnace will begin to operate automatically.

On the A/C controls page, press HEAT PUMP to activate the heat strip on the rooftop A/C unit.

---

**NOTE:** You will see the snowflake icon change to a heating symbol beneath the arrows. After a slight delay, the heat pump icon will begin to flash. When the heat strip on the rooftop A/C engages, the heating symbol beneath the arrows will change to red, and the fan icon will indicate the fan speed.

---

---

**NOTE:** The heat pump refers to the electric strip on each exterior rooftop A/C. The FURN button refers to the Aqua-Hot.

---



Figure 4-7: Heat Pump Controls

# **ALLEGRO BUS**

## **MAJOR APPLIANCES**

---

Chapter

5

## APPLIANCES & ACCESSORIES

### RESIDENTIAL REFRIGERATOR

The Allegro Bus is equipped with a 110 volt style residential refrigerator (Figure 5-1), which is powered from an outside source, or from the unit's generator or inverter, which uses a 12 volt battery power supply.

This unit operates as most home refrigerators do.

---

**NOTE:** While traveling, the refrigerator will be powered by the inverter.

---

For further operating and maintenance instructions, refer to the operating booklet found in the Owner's Information Package.

---

**NOTE:** While traveling, the 12 V battery is charged by the engine alternator.

---

The inverter must be ON for the residential electric refrigerator to operate, if not connected to shore power, or if the generator is not running.



Figure 5-1: Residential Refrigerator

## APPLIANCES & ACCESSORIES

### WOOD REFER-PANEL REFRIGERATOR (OPTIONAL)



To accentuate the appearance of your refrigerator, a wood refer-panel option is available for the Allegro Bus.

Figure 5-2: Wood Refer-Panel Option (Linen Style)

## APPLIANCES & ACCESSORIES

### MICROWAVE/CONVECTION RANGE

The Allegro Bus contains a microwave/convection oven (Figure 5-3). All microwave ranges operate on 120 volt AC electrical power, supplied either by the external electrical hookup or by the onboard electrical generator in the motorhome.

Touchpad controls are used for operating the convection microwave (i.e., cooking temperature, mode, power level, and cooking time). For basic operating instructions, care, and maintenance for the proper use of the microwave, refer to the specific manual in the Owner's Information Package.



Figure 5-3: Microwave

### AIR FILTRATION FAN



Figure 5-4: Air Filtration Fan

In the motorhome, the “exhaust” or air filtration fan (Figure 5-4) is built into the microwave, and its function is to filter the air and exhaust to the outside.

The filtration fan must be used whenever cooking is performed to filter any airborne cooking residues and heated air.

The filtration system can be used as supplemental filtration of other odors and gases including tobacco smoke, candle fumes, and related vapors. It contains filters, which can be removed and cleaned or replaced to ensure normal operation. Consult the particular owner's manual contained in the Owner's Information Package for more information.



## APPLIANCES & ACCESSORIES

### TRUE INDUCTION COOKTOP/WOLF COOKTOP (OPTIONAL)

The Allegro Bus is equipped with an induction cooktop (Figure 5-5) that requires 30 amp service, or the generator, to operate. Refer to the manufacturer's manual for more details. When both heating element "eyes" are ON, the combined temperature is 720 degrees Fahrenheit, or 383 degrees Celsius. Each "eye" automatically adjusts to maintain the combined temperature.

The optional Wolf cooktop can run both "eyes" at maximum temperature. Refer to the manufacturer's manual for more information.



Figure 5-5: Two-Burner True Induction Cook Top

The control panel features options on operating the following settings:

**HEATING** — This is the default function of the induction cook top. When pressing ON/OFF, the heating light will illuminate and the cook top will heat the cookware at 1200 W. The heat can be adjusted by touching the UP or DOWN arrows. There are 10 levels of power, with 10 being the highest.

**TEMPERATURE** — When pressing TEMP, the induction cook top will begin setting the temperature and the TEMP light will illuminate. The default temperature is 248 degrees Fahrenheit (120 degrees Celsius). The temperature can be adjusted by touching the UP or DOWN buttons.

---

**NOTE:** The temperature range is 140 degrees to 420 degrees Fahrenheit for a single "eye" (60 to 215 degrees Celsius).

---

**TIMER** — When pressing TIMER, the light of the TIMER and one of the lights on HEATING/TEMP will illuminate accordingly. The cook top will enter the Time Setting mode. Five seconds after setting, the window will automatically shift to the mode display of the corresponding function. To view the countdown time, press TIMER again. The display window will show you the remaining time.



## WARNING

**DO NOT USE** cooking appliances as a heating source for the motorhome. Cooking appliances require fresh air for safe operation. Before using any cooking appliance, make sure that an overhead vent or window is open and/or turn ON an exhaust fan. **DO NOT** place stove covers on cook top until it is cooled.

## APPLIANCES & ACCESSORIES



### DANGER

All LP gas-operated appliances in the motorhome will consume oxygen. If the motorhome is totally closed during such operation, the oxygen level might be reduced and the associated carbon monoxide level might be increased thereby causing possible harm or death to the occupants through asphyxiation. Always use these appliances with proper ventilation.



### WARNING

Portable fuel burning equipment, including wood and charcoal grills and stoves, should NEVER be used inside the motorhome. The use of this equipment inside the coach can cause fire or asphyxiation and could result in serious injury or death.



### DANGER

#### IF YOU SMELL GAS, YOU SHOULD IMMEDIATELY:

Extinguish any open flames, pilot lights, and all smoking materials. Do not touch or operate any electrical appliances or switches. Immediately shut off the gas supply at the main tank valve or supply connection. Open doors, windows, and other ventilation openings. Exit the RV to allow entrapped LP gas to dissipate. Have the LP gas system checked to locate and fix the sources of the leakage.

## APPLIANCES & ACCESSORIES

### DISHWASHER (OPTIONAL)

The Allegro Bus might be equipped with an optional compact dishwasher (Figure 5-6). The following operating instructions can be used to operate the dishwasher:

1. Load the dishes.
2. Add any detergent and rinse-aid solution.
3. Press the POWER button to turn the dishwasher ON (pushing this button again will turn the dishwasher OFF).



Figure 5-6: Dishwasher

---

**NOTE:** Opening the dishwasher will automatically turn ON the dishwasher for a 30 second period. To end a wash cycle before it is fully completed, press the POWER button; the dishwasher will pump any remaining water in the dishwasher out of the unit.

---

4. Select Wash Program. By pressing the PROGRAM button, the desired wash cycle can be selected. The dishwasher will remember the last selection made until a newer one is selected.
5. Check to ensure that the drain filter is flush with the filter plate and the spray arm can rotate within the dishwasher freely without impacting anything.
6. Start the dishwasher by closing the dishwasher door; then press the START/PAUSE button to begin the washing cycle. This button also has a DELAY START function.
7. Pause the dishwashing cycle, if desired, by pressing the START/PAUSE button; wait for three beeps to be heard, and then open the dishwasher. Restart the dishwasher (after closing the door) by pressing the START/PAUSE button.

---

**NOTE:** Forcing open the dishwasher door mid-cycle might cause damage and/or injury.

---

8. Finish the dishwashing cycle by noting when the dishwasher beeps six times to indicate the end of the wash cycle. At the end of the washing cycle, the drying fan will continue to run for a pre-determined time or until the door is opened. The drying fan assists in drying the washed contents and actually uses very little electrical energy in the process. It is normal for some water to remain in the drain filter area after the wash cycle is completed.

---

**NOTE:** Should a power failure occur when the dishwasher is operating, the dishwasher will stop. It might be impossible to open the dishwasher, depending on where it was interrupted in the dishwashing cycle. When the power is reapplied, the dishwasher will resume its operation at the point at which it was interrupted. When not in actual use, the dishwasher can be used to store dishes, cups, glasses, etc. as the dishwasher itself provides secure storage for these items while in transit.

---

## APPLIANCES & ACCESSORIES



### WARNING

The dishwasher must have 110V power or inverter power at all times to stay locked during transit. If not, the dishwasher could disengage during travel.

To ensure that the dishwasher is properly locked for travel, follow the steps below:

Push the center control located on the face of the dishwasher until it blinks green. Press the key button to the right of the center button until it turns red and compresses. This denotes that the dishwasher is in “lock down” mode.

To decompress the dishwasher, push the key button for five (5) seconds.

### STACKED WASHER/DRYER (OPTIONAL)

Your Allegro Bus might be equipped with an optional stacked washer/dryer (Figure 5-7). The optional stacked washer/dryer can operate on 30 or 50 amp service.

### NOTICE

Tiffin Motor Homes does not recommend operating the washer or dryer while traveling as this could damage internal components.

For specific information regarding the use of the stacked washer/dryer, consult the owner’s manuals found in the Owner’s Information Package.



Figure 5-7: Stacked Washer/Dryer

# ALLEGRO BUS

## ENTERTAINMENT

---

Chapter

6

## ENTERTAINMENT

# TELEVISION SYSTEM OPERATION

## TELEVISION ANTENNA

You can automatically search for channels that are active in your area by editing and scanning channels on your remote control. To set up the television, refer to the television instruction manual provided.

---

**NOTE:** The antenna booster is located in the front, right cabinet of your unit, and must be ON when using the antenna, and OFF when using cable.

---

---

**NOTE:** If the motorhome has been moved, the channels must be rescanned on each TV.

---

---

**NOTE:** Due to Tiffin Motor Homes' commitment to continuous research and development, some units might also contain televisions manufactured by other companies (LG, Samsung, etc.). Refer to the information in your Owner's Information Package on setup for the brands.

---

## TELEVISION SATELLITE DISH

Your motorhome is equipped with an in-motion TV satellite dish control system (Figure 6-1) to permit access to satellite television. The satellite is equipped with a high-definition receiver.

The motorhome satellite is capable of receiving High Definition (HD) satellite signal from Dish Network. However, you must subscribe to HD service.

The dome satellite, on top of the coach, can be raised to allow easy access to change switches to a new satellite provider.

Follow the directions in the Owner's Manual for this dish-control mechanism to obtain the best orientation of the satellite dish for desired television reception.



Figure 6-1: Dome Satellite

### **To set up your satellite receiver for Dish Network (Factory Configuration):**

1. Remove the satellite dome cover on top of the motorhome by releasing the screws around the dome.
2. Change dish settings to 4-7-8 by adjusting the dip switches to the DOWN position (8 is already in the DOWN position).
3. Re-install the dome.



## ENTERTAINMENT

on the Dish remote:

1. Press MENU.
2. Press the no. 6 button.
3. Press the no. 1 button.
4. Press the no. 1 button again.

This will bring up the Dish screen. Go to the right-hand column where it says "CHECK SWITCH."

Once this is done, EXIT the system, then press 0-0-0 to download the information.

### TELEVISION SETS

Your motorhome is High Definition (HD) ready and is capable of receiving channels that are broadcasting in High Definition.

In order to receive a clear picture from your satellite dish, you must subscribe to High Definition (HD) service. Your motorhome is equipped with an automatic switching box that enables you to easily change between TV input modes.

To change the mode of your television, press INPUT on your remote control. Then, select TV, Blu-ray, or Satellite, and press OK.



Figure 6-2: Living Area Television Set

---

**NOTE:** The booster must be ON for the antenna and OFF for the cable. The television sets (Figure 6-2) are located in different areas of the motorhome. All TV sets are High Definition.

---

The televisions are powered by 120-volt AC electricity; therefore, the motorhome must either be plugged into an external source of AC power or using on-board power from the generator. An optional inverter would also permit the 12-volt DC power to be converted into 120 volt AC for the televisions.

Detailed operation of the televisions is provided in the accompanying owner's manuals found in the Owner's Information Package included with the motorhome.

## ENTERTAINMENT

### TELEVISION LIFT IN LIVING ROOM (OPTIONAL ON SOME MODELS)

**NOTE:** The inverter must be ON to use the TV lift function.

Some Allegro Buses come equipped with an optional TV lift in the living room area and the bedroom. (Figure 6-3, Figure 6-4, and Figure 6-5).



Figure 6-3: Television Lift (Before Lift)



Figure 6-4: Television Lift (Lifting)



Figure 6-5: Television Lift (After Lift)

The Television Lift mechanism can be operated by pushing a button on the Spyder control panel on the wall (Figure 6-6) or by pressing the buttons on the television lift key fob (Available in bedroom only) (Not available in model 45FP) (Figure 6-7).

## ENTERTAINMENT



Figure 6-6: Television Lift Control Panel (located in the living room slide-out box)



Figure 6-7: Bedroom television Lift Control Fob. Not available on 45 FP Model.

## TELEVISION LIFT IN BEDROOM (OPTIONAL)

The Allegro Bus can also be equipped with an optional TV lift in the bedroom area (Figure 6-8).

The TV Lift mechanism can be operated using the touch screens located on the end walls of the bedside box (Figure 6-9) or by pressing the buttons on the TV lift key fob (Figure 6-7).



Figure 6-9: Rear TV Lift on 5" Touch Screen



Figure 6-8: Rear TV Lift

## ENTERTAINMENT

### EXTERIOR TELEVISION

The Allegro Bus is equipped with a 43" external television that can be viewed from outside the motorhome by raising the protective TV door on the side. A power exterior TV door option is also available.



Figure 6-10: Exterior TV

### INFRARED REPEATER

The motorhome features an infrared repeater, which enables the owner to utilize the satellite remote control from various areas of the coach. An infrared repeater will be located in the bedroom and by the overhead TV located in the driver's area. If your motorhome has the optional outside entertainment system, this feature will be located on it also.

To utilize the infrared repeater, locate the one inside the cabinet that contains the DVD player. Peel the adhesive backing from the back of the infrared repeater and line the infrared repeater against the satellite receiver's infrared repeater. This will allow the infrared repeater to operate when the satellite remote control is directed toward the infrared repeater situated next to the TV.

You will now have the convenience of changing the satellite receiver channels from various areas of the coach.

---

**NOTE:** The infrared repeater will not work with a Dish Network receiver.

---

## ENTERTAINMENT

### SOUND BAR

The L.G. sound bar automatically comes on with the TV. No setup is required.



### BLU-RAY PLAYER

The standard Blu-ray player (Figure 6-11) is located in a vented cabinet in the bedroom of the coach.



Figure 6-11: Player

The player allows accessibility to play Blu-ray, iPods, and other electronic devices as well as viewing photos and playing music. Detailed operation of the player is provided in the accompanying manuals found in the Owner's Information Package included with the motorhome.

# ALLEGRO BUS

## CABINETS & FURNITURE

---

Chapter

7



# CABINETS & FURNITURE

## CABINETS

Your Allegro Bus contains cabinetry (Figure 7-1) installed throughout the entire motorhome from the driver's area, through the kitchen/dining areas, and back into the bedroom.

The cabinetry is available in contemporary and traditional fascia, and has been designed and built to provide ample storage space, to be easily accessible, and to be conveniently located to support the areas of concern.



Figure 7-1: Living Room Cabinets (Contemporary Fascia)

Construction of these cabinets incorporates various hardwoods, raised panels, cabinet doors, and supports. Door pulls, handles, and knobs are installed in a style complementing the particular décor of each motorhome so that an aesthetically pleasing, as well as fully functional, storage capacity is realized.

For the many floor plans available in the Allegro Bus product line, cabinet design has been optimized to provide maximal storage for each floor plan available. Accordingly, the Allegro Bus can readily accommodate the routine materials, supplies, and customer-specific items desired for any travel requirements.

These cabinets are designed to contain stored supplies quite securely during travel to minimize or eliminate the possibility of shifting or spilling of cabinet contents during travel. But, when the motorhome is parked, all stored items are readily available in the cabinets for the convenience of the users.

As the storage requirements will vary somewhat from one floor plan to another, general observations can be made about the Tiffin-supplied cabinetry, which might or might not be applicable for your specific motorhome configuration.

Cabinets are provided in the kitchen/dining area to accommodate the routine cooking utensils and groceries normally required for travel. Storage space within these cabinets has been designed to accommodate the typical sizes and configurations of food supplies (e.g., cereal boxes, condiments, canned goods, bottled liquids) normally taken on travel trips.

Based on Tiffin Motor Homes' extensive experience with travel requirements of the seasoned motorhome users and from Tiffin Motor Homes' own research and development in cabinet design requirements, the cabinets offer the greatest storage capacity possible.

In the bathroom and bedroom, additional cabinets are available for storage of sundries and toiletries specific to these areas.

## CABINETS & FURNITURE



Figure 7-2: Kitchen Cabinets

In the kitchen, a color-coordinated countertop is provided on top of the floor-mounted cabinets (Figure 7-2). To maintain the appearance of the countertop, clean with a damp cloth. If spotting occurs, clean the countertop with a damp cloth and a mild liquid soap. Should some dried-on residue still persist, let a damp cloth moistened with the liquid cleaner stand directly on top of that residue for 15-30 minutes to loosen the residue, then clean that spot accordingly.

---

**NOTE:** Strong chemicals, solvents, and cleaners (e.g., oven cleaner) might damage the surface; so do not use any products not specifically designed for countertop cleaning.

---

The countertop might be physically damaged, too, if proper care is not taken. Do not cut anything (e.g., vegetables, fruits) directly on the countertop; rather, use a cutting board on top of the countertop to provide necessary protection. Excessive heat might also damage the countertop; therefore, any pots or pans taken directly from the range or oven must not be placed directly on the countertop; rather, use trivets or some other form of fireproof heat insulators to hold very hot pots or pans on the countertop.

All drawers are equipped with metal slides to provide additional load-bearing strength, and to permit effortless opening and closing of the drawers, even when they are fully loaded. These metal guides have a slight “locking” action, when closed. To open the drawers, slightly lift up on the drawer handle and then pull the drawer open.

To close, push the drawer closed until it “clicks” back into place (i.e., the locking action is engaged).

As this cabinetry is typically of furniture-grade quality, any commercial furniture polish or cleaner can be used. Do not try to soak these wooden surfaces with water or any other liquid; be sure to wipe up spills or residues of any fluids that contact these surfaces to preclude any staining or discoloration of the cabinet surfaces.

## CABINETS & FURNITURE

### SLIDE-OUT PANTRY



Figure 7-3: Slide-Out Pantry (Closed)

On some floor plans of the Allegro Bus, a slide-out pantry is located in the kitchen area (Figure 7-3). The slide-out pantry has a safety lock that engages while the motorhome ignition switch is in the ON position to prevent the slide-out from accidentally sliding open while traveling down the road.

If the ignition switch is ON, the pantry may be accessed by pressing the round silver button at the top of the pantry (Figure 7-4), and pulling the cabinet handle.

If the ignition switch is in the OFF position, a simple pull on the handle will allow access to the pantry.



Figure 7-4: Button to Unlock Pantry



Figure 7-5: Slide-Out Pantry (Opening)



Figure 7-6: Slide-Out Pantry (Opened)

## CABINETS & FURNITURE

### FURNITURE

#### KITCHEN, LIVING & DINING AREAS

On the Allegro Bus, a built-in dinette computer workstation (Figure 7-7) is standard. A booth/dinette is optional.

The living room contains a sofa (Figure 7-8), which converts into a bed.

It may be one of two styles—either a standard jack knife bed, or an optional air coil hide-a-bed sofa sleeper. The optional air coil hide-a-bed sofa sleeper includes an air pump.



Figure 7-7: Computer Work Station

It operates by depressing the black latch and unfolding the bed. The sofa is custom coordinated with the décor of the motorhome.

#### To convert the sofa into a bed:

1. Remove the accent pillows.
2. Under the seat cushion, locate the “black tab” and slide the tab to the left or the right, and then pull upwards on the seat portion of the sofa—this will cause the sofa seat to open, extend, and convert into a bed.



## CABINETS & FURNITURE



Figure 7-8: Sofa

## CABINETS & FURNITURE



Figure 7-9: Driver and Passenger Chairs swivel to the living area

The driver's seat (Figure 7-9) is manually operated and has swivel features. When the motorhome is parked, the driver's seat can be swiveled to face into the living room. To swivel this chair, first extend the slide-out room (see Chapter 10). Then, move the chair backwards as far as possible to gain clearance from the steering wheel. Now the chair can be swiveled without interference.

The passenger's seat is also a manually operated seat having essentially the same controls as that of the driver's seat, and it is operated accordingly. The passenger's seat provides a comfortable footrest for your use.

Both the passenger and driver's seat comes equipped with a heater and lumbar support. The switches for these features (Figure 7-10 and Figure 7-11) are located on the side of each seat.



Figure 7-10: Heated Seat Switch



Figure 7-11: Lumbar Support Switch



## CABINETS & FURNITURE

### BEDROOM AREA

If a décor-coordinated, quilted bedspread with accessorized pillow shams and accent pillows (Figure 7-12) are included with the bedroom suit, Tiffin Motor Homes recommends that the bedspread be only dry-cleaned to preserve the quality of the bedspread for the longest time possible.

Treatment of the bedspread with any of the stain-resistant sprays (e.g., Scotchgard, etc.) will also make the bedspread more resistant to stains and fabric damage and, thus, provide many years of dependable service.



Figure 7-12: Bedroom Décor

### POWER SMART BED

Some Allegro Bus models have the Power Smart Bed option. This option allows the bed to be adjusted to different positions: (a) sliding the mattress out from the wall to aid in making the bed, (b) raising the head of the bed for reading and watching television, and (c) placing the bed in a horizontal position against the headboard.



Figure 7-13: (a)



Figure 7-14: (b)



Figure 7-15: (c)

To adjust the positions, a touch pad is located at the bedside (Figure 7-10).



Figure 7-16: Touchpad

# ALLEGRO BUS

## STRUCTURAL FEATURES

---

Chapter

8

## STRUCTURAL FEATURES

### CHASSIS FEATURES

The Powerglide chassis of your Tiffin Motor Homes Allegro Bus was built by and is warranted by Tiffin. The operating instructions for the chassis are included in the Chassis Owner's Manual, which is provided with your Allegro Bus and is a part of the Owner's Information Package furnished to you by your Tiffin Motor Homes dealership.

Before you begin using your Allegro Bus, read and follow all recommendations for the proper care, operation, and maintenance of the chassis—this will ensure a pleasant, trouble-free use of the vehicle. If you have any questions about the chassis, however, contact your chassis manufacturer.

Call 256-356-8661 ext. 2382 for questions about your chassis, and 256-356-8661 ext. 3385 for parts.



Figure 8-1: Powerglide Chassis

# ALLEGRO BUS

## ELECTRICAL FEATURES

---

Chapter

9

# ELECTRICAL FEATURES

## GENERAL INFORMATION

There are two electrical systems in your motorhome. These are the 12 volt DC (VDC) system and the 120 volt AC (VAC) system. Most standard appliances require the 120 VAC system, while the majority of the lighting systems used in the motorhome use the 12 VDC electrical system.

The electrical power for the 12 VDC system is supplied by the batteries of the motorhome. Those batteries are charged by a power converter. The alternator also charges the batteries when the engine is running.

The electrical power for the 120 VAC is supplied by the power cord when the motorhome is connected to an external power source or when the on-board electrical generator is in operation. The converter/inverter can also supply 120 VAC electrical power (to limited outlets and limited appliances)—the inverter transforms the 12 VDC electrical power from the batteries into the 120 VAC electrical power for the basic appliances.

If you ordered the (Optional) Go Power solar system, the controls for this system are in the Spyder system. The information in the figure is for reference purposes only. (Figure 7-1)



Figure 7-1 Solar Controls

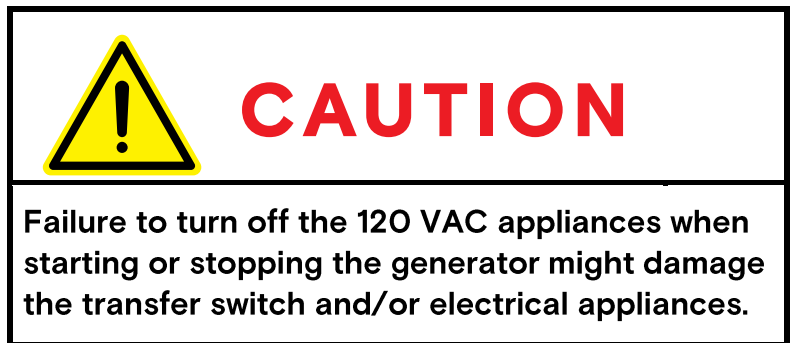

To connect the motorhome to an external source of 120 VAC electrical power, Tiffin Motor Homes recommends that all of the circuit breakers be in the OFF position, (this is done to prevent any power surge when connecting the motorhome to the external power source), and then unwind the power cord from the electrical compartment located in an external compartment. The standard, flexible, power cord supplied with the motorhome is designed to handle up to 50 amperes. Make sure that the pins in the male end of the plug are oriented correctly so that they match the power cable, and that they are in good condition (i.e., are not bent or damaged).

If there is a circuit breaker switch at the “plug” end of the power cord, that breaker must be turned OFF before making the connection. Insert the plug into the mating outlet, and then turn the circuit breaker ON. Close and lock the electrical compartment door to protect the contents and to keep them clean and dry. Close the cover on the power box, if so equipped, to avoid an unintentional disconnection and to keep the contents clean and dry. Then switch the main breaker to the ON position.

When properly connected, the 120 VAC system provides power to all the 120 VAC circuits and outlets when the main breaker is turned ON.

## ELECTRICAL FEATURES

### ELECTRICAL CAUTIONS



## CAUTION

- Careless handling of electrical components can be fatal. Do not touch or use electrical components or appliances while feet are bare, hands are wet or standing in water or on wet ground.
- Do not touch an extension cord to the utility power cord.
- Avoid overloading circuits and replace fuses or circuit breakers with those of the same size and amps only. **DO NOT** use a higher rated fuse or breaker.
- Do not plug the utility power cord into an outlet that is not grounded.
- Do not adapt a plug to connect to a receptacle that it is not designed for.
- Be sure that all electrical appliances used inside the motorhome contain three-prong plugs for proper grounding.
- Use caution when handling or working near electrical storage batteries.
- Always remove jewelry and wear protective clothing and eyewear when working on an electrical matter.

### CIRCUIT BREAKER BOXES

## NOTICE

**Be sure the air conditioning units are turned OFF before connecting or disconnecting to or from the shore power.**

If there is no power to the coach from the shore or generator, then check the generator circuit breaker. If the circuit breakers are not tripped in the generator or the coach, the transfer box might need to be replaced. For more detailed information on the automatic transfer switch, refer to the specific owner's instructions found in the Owner's Information Package.

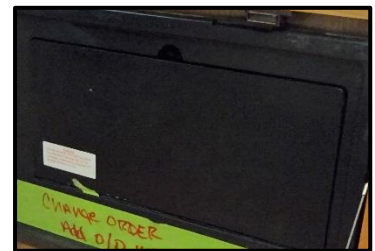

Figure 9-1: Circuit Breaker Box



## ELECTRICAL FEATURES



### CAUTION

**Service to this box must be performed by a qualified technician. DO NOT attempt to remove the cover unless the shore cord is unplugged and the generator is turned OFF.**



### CAUTION

**Be careful when working around the connections, as an accidental electrical short to ground (i.e., briefly connecting the “positive” or “hot” terminal to any part of the chassis) can be hazardous.**

Interior 120 VAC and 12 VDC breaker boxes (Figure 9-1) are typically located in the rear closet, bedroom vanity lower cabinet, hall bathroom overhead cabinet, or rear bathroom overhead cabinet.

Exterior House 12 VDC breaker boxes are typically located either in front of, or behind, the driver’s front wheel well electrical compartment.

The circuit breakers and associated fuses are installed to protect the electrical system of the motorhome from any overloads. Do not attempt to change the electrical circuitry or to add appliances yourself.

The 120 VAC power supplied from shoreline or generator enters the MAIN circuit breaker, located on the left side of the AC breaker box. This double circuit breaker will disconnect power from all 120 VAC appliances when tripped. Each circuit breaker has a label giving an indication of the device it is passing power to. Check these circuit breakers if a 120 VAC powered device is not working.

Fusing is provided for 12 VDC circuits, such as interior decorative and overhead lighting, water heater, TV switching box, slide-out lights, power roof vents, monitor panel, and the passenger side console switch panel.

Additional House 12 VDC breaker boxes are typically located in the front driver’s electrical box in front of, or behind, the wheel well.

A multiplex-based system with power distribution modules supply the 12 VDC functions for the chassis functions. These modules and associated circuit protecting fuses/breakers are located either in front of, or behind, the driver’s front wheel well electrical compartment.

Located on the passenger-side rear compartment is another circuit panel, which contains the following circuit breakers: slide-outs, 12 VDC disconnect storage box lights, and solenoids.

## ELECTRICAL FEATURES



### WARNING

To protect the 12 VDC system, **DO NOT STORE** anything in circuit panel compartments (e.g., toolbox), which might jostle around, break through the shield, and short out the 12 VDC system. If this system were short-circuited, extensive damage and/or fire could result.

## AUXILIARY START SWITCH



Figure 9-2: Auxiliary Start

The auxiliary start switch (Figure 9-2) is located on the switch panel to the left of the steering wheel in front of the driver's-side console box.

This switch connects the motorhome coach batteries to the chassis batteries—this allows the chassis batteries to “borrow” power from the coach batteries to assist in starting the engine.

If the chassis batteries cannot start the engine by turning the ignition key, hold down the battery-boost switch for at least 60 seconds and retry starting the engine.

When attempting to use the auxiliary start switch function, Tiffin Motor Homes recommends that you press and hold the switch for about 60 seconds before trying to start the engine. This gives the two sets of batteries (house and chassis) a chance to equalize before engaging the starter. The multiplex system that controls most chassis functions will need to reach optimal voltage range to ensure proper operation as well.

## ELECTRICAL FEATURES

### BATTERY INSPECTION AND CARE



Figure 9-3: House Batteries

The motorhome batteries (Figure 9-3) are located on a sliding tray, which extend from an underneath compartment. The Allegro Bus house batteries are located toward the front driver's side.

To access these batteries, undo the latches securing the sliding assembly, and slide the tray out of the compartment. When access to these batteries is no longer needed, replace the sliding battery assembly, making sure that it is securely latched.

When batteries are not used for extended periods of time, they will gradually lose their electrical charge. Therefore, it is necessary to periodically recharge the batteries to increase the operational lives of the batteries.

It is also necessary to check the external condition of the batteries on a regular basis. Look for cracks in the battery case and cover. Check the vent plugs and replace them if they are cracked or broken. Keep the battery clean.

Since accumulations of dirt and acid residue around the battery terminals might provide an electrical path for discharging the battery, the area around the terminals must be cleaned periodically.

You can use an old toothbrush and a sparse amount of a diluted solution of baking soda (sodium bicarbonate) and water (distilled or de-ionized, preferred; tap water, acceptable) to clean and neutralize any acidic build-up around the battery terminals. If there is any foaming on the top of the battery, this indicates that acidic residues are being neutralized. Rinse the cleaned areas thoroughly with distilled or de-ionized water (tap water is okay, too).

Avoid getting the baking-soda solution into the battery fill plugs to each battery cell; this would drastically reduce the effectiveness of the battery (by neutralizing the sulfuric acid in the battery cells) or, worse, "kill" the battery. Dry the battery cables and terminals to prevent corrosion; to protect those terminals further, use a plastic ignition spray on the terminals. Do not use grease on the terminals, especially on the metal-to-metal connections, as grease might act as an insulator and keep the battery electrical power from entering the cables.

If the batteries are not going to be used for an extended period, remove them from the motorhome and store in a warm, dry place. Tiffin Motor Homes recommends that this service be performed by a qualified service technician, as the process is usually too complicated for the average owner to perform. For those who might wish to perform this service themselves, use the following procedure: Mark the battery cables ("+" sign or "red" for the positive cable; "-" sign or "black" for the negative cable) so that they can be properly reconnected again later. These batteries require periodic recharging to maintain their full charge.

Over time, the batteries will lose some of the water used with the sulfuric acid in the batteries. Following manufacturer's recommendations as found in the Owner's Information Package, periodically check the

## **ELECTRICAL FEATURES**

fluid levels in all the cells of the batteries (be sure to use safety eyewear during this process) and fill those that are low with water (distilled or de-ionized water is preferred; tap water is okay).

Do not overfill the cells; follow the filling directions exactly. Check the battery on a regular basis to realize the fullest service possible from the batteries over the longest time possible.

If the motorhome is to be stored for an extended period, disconnect the 12 VDC battery system—this procedure will prevent unnecessary drain and corrosion of the batteries and their terminals.

## ELECTRICAL FEATURES

### NOTICE

Disconnect the 120 VAC electrical power cord and the negative terminal from the coach batteries **BEFORE** working on the motorhome electrical system.

### NOTICE

If the motorhome ever requires any welding operations on the frame, first disconnect the chassis batteries. Failure to do so will destroy all of the chassis computer system.



### WARNING

Remove rings, metal watchbands, and any other metal jewelry before working around batteries. If any metallic object (tool, jewelry, etc.) contacts the positive battery terminal or any connection made to that terminal **AND** also contacts the negative terminal or any of its connections, a **SEVERE ELECTRICAL SHORT** will occur, which could result in an explosion, fire, and/or personal injury. Lead-acid batteries contain diluted sulfuric acid, which can be dangerous; avoid direct contact with any battery fluids. Wear eye protection.

## HOUSE BATTERY DISCONNECT PANEL

The house battery disconnect panel (Figure 9-4) is located in the cargo storage area on the driver side. Along with the inverter switch and several breakers, the rotary switch labeled House Battery Master Switch can disconnect the house batteries when the vehicle is in storage for long periods.

Rotating this switch disconnects the house batteries only, not the engine batteries. This feature is designed to disconnect all 12 VDC circuitry from the batteries and prevent them from being drained during storage.



Figure 9-4: House Battery Disconnect Panel Switch

## ELECTRICAL FEATURES

### ENGINE BATTERY DISCONNECT PANEL

The engine battery disconnect panel is located in the outside battery storage compartment, on the rear of the passenger's side of the motorhome.

On the upper, right-hand side of that compartment is another rotary switch (Figure 9-5) which, when activated, disconnects the "engine" batteries. When the motorhome is to be stored for any length of time, it is wise to disconnect these two 12 VDC systems.

When the motorhome is removed from storage, rotate the upper, right-hand disconnect switch to reconnect the 12 VDC power.

Tiffin Motor Homes recommends disconnecting the engine batteries while servicing the coach.



Figure 9-5: Engine Battery Disconnect Panel Switch

For routine, short-term use, there is a "12 VDC disconnect" switch on the switch console located in the stairwell of the Allegro Bus (Figure 9-6). This switch—located at the bottom of the switch console—can be used to disconnect the "house" battery from most of the 12 VDC circuits in the motorhome so that there is no inadvertent drain on the battery while the owner is away from the motorhome (e.g., shopping trips, day trips for sightseeing).



Figure 9-6: 12 VDC Disconnect Switch

Tiffin Motor Homes also recommends periodically checking the fluid levels in the batteries constituting the 12 VDC "house" battery system to make sure that all fluid levels are properly maintained; otherwise, a full charge cannot be maintained in the

batteries.

Your motorhome is also equipped with a battery maintainer that automatically activates when the motorhome is plugged into shore power in order to maintain charge in the engine batteries.

### EXTERNAL SOLAR PORT

Your motorhome is equipped with an external Solar Port located in the water bay. It allows you to plug in your own solar panel. The port is designed to handle a maximum of twenty (20) amps. Your solar panel **MUST** have its own controller. Tiffin Motor Homes is not responsible for the improper use of the External Solar Port.





## ELECTRICAL FEATURES

### 12 VOLT DC (VDC) RECEPTACLES

Your motorhome is equipped with a 12 VDC receptacle conveniently located inside of the center console (Figure 9-5). This 12 VDC receptacle can be used for providing power to various items, such as cellular phones, personal computers, or portable communications equipment.

This receptacle is usually found on the bulkhead in front of the passenger's seat so that it is conveniently available. This receptacle accommodates the "cigarette-lighter" type of connector.



Figure 9-5: 12 VDC Receptacle

### USB RECEPTACLES



Figure 9-6: USB Receptacle

The motorhome is equipped with USB ports (Figure 9-6) conveniently located on the front dashboard and in the bedroom area as well as on the passenger console. These ports allow for easy access when charging cell phones, laptop computers, iPods, iPads, or tablets.

### CONVERTER/INVERTER

Your motorhome is equipped with a Magnum Pure Sine Wave Inverter (Figure 9-7). When the 120 VAC power is not available, either from the power cord or from the generator, the inverter/charger may be used. The control panel for the inverter/charger is located above the driver's seat.

The inverter/charger has two modes of operation: INVERTER (providing power to your appliances from the batteries) and AC (running from shore power or a generator). Whenever the inverter is in AC mode, it passes power directly to your appliances as well as recharges the batteries using a three-stage battery charger (Bulk, Absorption, and Float). This approach to battery charging provides rapid and complete charging cycles without placing undue stress on the batteries. Inverter operation must be enabled on the remote panel.

With search mode enabled, the inverter pulses the AC output looking for an electrical appliance (typically 5 to 100 watts, depending upon the setting you have selected).

When there is no load detected, the inverter automatically goes into search mode (sleep) to minimize energy consumption. During this time, the inverter's green LED flashes (fast) to indicate SEARCH mode.



Figure 9-7: Converter/Inverter

## ELECTRICAL FEATURES

When an appliance is switched on inside the coach, the inverter recognizes the need for power and automatically starts the inverter.

Whenever AC Shore Power is no longer sensed, the inverter automatically transfers to battery power with no interruption to your appliances. The inverter's green LED flashes once every 2 seconds (medium flash) to indicate it is running on battery power and providing AC to the coach.

Whenever AC Shore Power is sensed, the inverter automatically transfers to the shore power with minimal interruption to your appliances.

Whenever the inverter is running on nominal AC shore power, it charges the batteries. The inverter's green LED stays ON (solid) to indicate the first stage of charging. During bulk charging, the charger supplies the maximum amount of constant current to the batteries. As the battery voltage rises to a set value, the charger will then switch to the next charging mode.

As the inverter continues to run on nominal AC Shore Power, and the batteries have been successfully bulk charged, the charger enters its second stage of charging. The inverter's green LED flashes once every second (fast flash) to indicate absorption charging for 1-3 hours depending upon the battery bank selection. The charger then switches to its final mode.

As AC shore power continues the inverter's green LED flashes once every 8 seconds (slow flash) to indicate the third and final stage of charging. The batteries are held at the float voltage as long as AC is present at the inverter's input. Float charging reduces battery gassing, minimizes watering requirements (for flooded batteries), and ensures that the batteries are maintained at optimum capacity.

The inverter monitors the AC Shore Power, the batteries, and itself. Whenever a condition occurs that is outside the normal operating parameters, the inverter will take the necessary steps to protect your appliances, batteries, or itself from damage. Whenever the battery voltage reaches a low level, the inverter will initiate Low Battery Cut-Off (LBCO), which automatically shuts the inverter down, along with all connected loads, to protect the batteries from over-discharge damage. The inverter's LED turns OFF to indicate the fault condition.

As the inverter is charging, it constantly monitors the batteries. In the event that the battery voltage level becomes too high, it automatically turns off the battery charger to protect the batteries from damage. The inverter's LED turns OFF to indicate the fault condition.

---

**NOTE:** High battery voltage might be caused by excessive voltage from the alternator, solar panels, or other external charging sources.

---

During inverter and AC Shore Power operation, the inverter monitors the AC and DC circuits. In the event of a short-circuit or overload condition, the inverter will shut down. The inverter's LED turns OFF to indicate the fault condition. During inverter operation, if the inverter becomes overheated, it will shut down to protect itself from damage. The inverter's LED turns OFF to indicate the fault condition. For further reading and additional information on the above, reference your inverter/charger manual that will be found in your Owner's Information Package.

## ELECTRICAL FEATURES

### 120 VOLT (VAC) AC RECEPTACLES

Your motorhome is equipped with several 120 VAC receptacles (Figure 9-8) located throughout the interior of the motorhome. These 120 VAC receptacles are of the “three-prong” variety; the third prong being a grounding pin that provides adequate grounding to protect one from any electrical shock.

For these receptacles to work properly, do not use an adapter, cheater, or extension cord, which defeats the function of the grounding pin. For the same reason, never remove or bend away the ground prong or pin from any three-prong AC plug so that it would fit a two-prong AC receptacle (i.e., an ungrounded AC receptacle).

Never operate the motorhome if there is an electrical short present, as an electrical short might deliver an electrical shock to anyone coming in contact with the exterior of the unit.

If you feel even the slightest of electrical shock, immediately disconnect the unit from the 120 VAC power source and locate the electrical fault (i.e., typically, it is a break in the grounding circuit).

Do not reconnect the 120 VAC power until after the electrical fault is fixed—the grounding circuit must be continuous from the frame to the distribution panel, to the power cord, and to the earth ground so that electrical-shock protection is realized.



Figure 9-8: 120 VAC Receptacle

### GROUND-FAULT-CIRCUIT-INTERRUPT RECEPTACLES

In the kitchen and bath areas, there are 120 VAC GFCI receptacles (Figure 9-9), which provide greater protection against inadvertent electrical shocks.

These specialized GFCI receptacles provide both overload and short-circuit protection for the user. The electrical receptacles located in the slide-out are wired through the kitchen GFCI. The exterior receptacles are wired through the bathroom GFCI. Consequently, if an appliance plugged into a slide-out or exterior receptacle is not working, check for a tripped GFCI in the kitchen or bathroom.

All GFCI-protected receptacles are marked as such, but only one of them might have two pushbuttons on the receptacle (as shown in the picture). The upper pushbutton is a “test” button, which can be used to ensure that the GFCI function is working.

**To reset this GFCI breaker**, push the lower button (the “reset” button) to restore power to all the GDCI receptacles on this circuit.



Figure 9-9: GFCI Receptacle

## ELECTRICAL FEATURES

These receptacles protect the user from ground faults between an electrically “hot” wire and ground. The GFCI will not reduce the shock hazard if the short is between a neutral and “hot” wire, or two “hot-load” wires.

The GFCI must be tested at least once a month. The 120 VAC electrical system must be ON for the GFCI to be tested.

**To test the GFCI**, the reset button must be pushed in fully before starting the test. Push the test button; this will cause the reset button to pop out, which means that the protected circuits have been disconnected. Push the reset button back in until a “click” is heard—this will reactivate the protected circuit. If the GFCI is working properly, the reset button will remain in the “in” position.

## POP-UP 110 VOLT/USB PORTS



Figure 9-10: Pop-Up  
110 Volt/USB Ports

In the Kitchen/Dinette area, the Allegro Bus is equipped with a pop-up electrical panel that provides two 110-volt outlets and two USB ports.

## ELECTRICAL GENERATOR

The Allegro Bus uses a 10.0 KW electrical generator (Figure 9-11), which is conveniently located by opening the front hood of the motorhome.

Before starting or stopping the generator, make sure that all the 120 VAC appliances are turned OFF.

After the generator has been started, wait until the transfer switch has connected before turning ON any of the appliances.

The generator can be started from either the remote-start switch located on the dash or directly at the generator itself. The hour meter installed on the generator records the number of hours of operation of the generator motor—this elapsed time is needed for observing necessary maintenance schedules on the generator.

For more detailed operating instructions and to determine necessary preventive maintenance schedules and procedures, review the manufacturer’s owner’s manual.



Figure 9-11: Electrical Generator

## ELECTRICAL FEATURES



# CAUTION

**Failure to turn OFF the 120 VAC appliances when starting or stopping the generator might damage the transfer switch and/or electrical appliances.**

## ENERGY MANAGEMENT SYSTEM

The energy management system (EMS) (Figure 9-12) distributes all the 120 VAC power throughout the motorhome, whether it comes from the shore power, the generator, or the inverter. The EMS monitors the incoming power, and manages the power to reduce circuit breaker tripping. It does this by briefly shedding power to the loads under its control when the user turns on other more critical appliances in the motorhome. EMS restores power when the appliance is turned off. The EMS panel displays the status of incoming power and the controlled loads.

When coupled with an inverter, EMS reduces battery charge rate before shedding any loads. Working together, an inverter assist feature is available. Normally the inverter is at rest when shore power is available. EMS utilizes the inverter and the coach battery bank to smooth out peak load demands. The inverter assist feature scales back the charge rate in order to have more 120 VAC power available for the appliances.



Figure 9-12: Energy Management System

## ELECTRICAL POWER CORD REEL

The electric power cord reel (Figure 9-13) enables you to manually extract the power cord reel. To retract the power cord, hold the switch until the power cord is fully retracted.



## ELECTRICAL FEATURES



Figure 9-13:  
Electrical Power  
Cord Reel

### AUTOMATIC TRANSFER SWITCH

The automatic transfer box switches 120V AC power from the shore or generator to the coach's main distribution panel. The transfer box has a delay of around three seconds before switching power to the shore, and a delay of around 30 seconds before switching power to the generator.

**If the unit is plugged into the shore but there is no power to the coach**, then make sure the shore outlet has power. If power is present, this might indicate that the unit is sensing an open neutral condition. Start the generator; if the power is restored, then either the shore plug or the outlet might be defective (the neutral line might be broken).

### FUSE BLOCKS

Some of the electrical circuitry within the motorhome is protected by various fusing systems. These fuse blocks protect some of the major electrical systems of immediate concern to the driver.

The electrical circuits protected by the under-dash fuse block include: headlights, panel light for dashboard, taillights, optional jacks, turn signals, cruise control, engine computer, accessory fuses, heater, and dash air conditioning. Additionally, there is another chassis fuse panel that works in conjunction with the chassis fuse panel and provides comparable protection for the above-listed circuits.

### SEVEN-PIN TOWING CONNECTOR

Your motorhome is equipped with a standard, 7-pin connector near the towing hitch at the rear of motorhome to supply the necessary circuitry to control a towed vehicle.

The wiring of that connector is shown in the accompanying diagram.

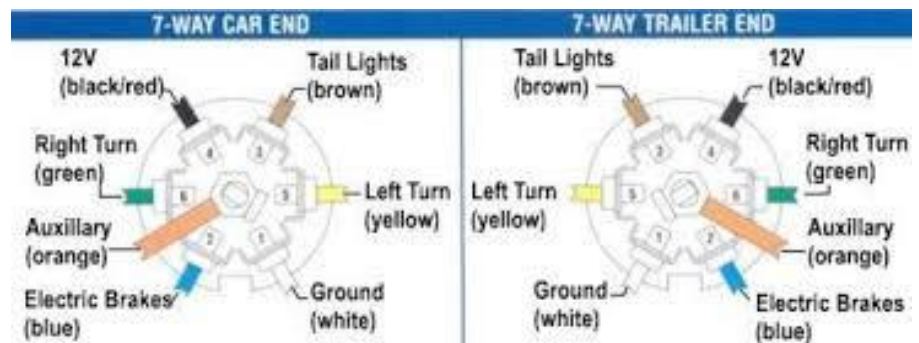

7-  
the



## ELECTRICAL FEATURES

Make sure that any cable from the vehicle to be towed is wired correctly to mate properly with the connections shown in the connector. If in doubt about proper wiring, have a qualified service technician prepare and install the necessary cable to mate with the 7-pin connector on the motorhome to ensure proper operation subsequently when any vehicle is actually towed by the motorhome.

When the towed vehicle is uncoupled from the motorhome and the cable is disconnected from the 7 pin connector, be sure to close the spring-hinged cover plate on the connector to protect the contact pins from dirt or debris. In a similar manner, protect the cable end from weather, or debris. One method could be to place the connector end in a heavy-gauge plastic bag (e.g., polypropylene, polyethylene, etc.), secure the bag tightly around the cable with a stout elastic band or tape, and then mount the secured cable in a manner to keep it both from mechanical damage and water intrusion.

When the towed vehicle is again coupled to the motorhome through the towing hitch and the cable is again connected to the 7-pin connector, make sure the resultant connection is tight and solid so that the connection does not jar loose during use. Several supplemental methods to secure that connection have been used; some of which include securing the connection with a strong rubber band or with Velcro-type fasteners to provide a supplemental mechanical backup to the actual electromechanical connection. If a conversion adapter to convert the round, 7-pin connector to a flat, 4-pin connector is needed, purchase one from any RV after-market store.

### WIFI ANTENNA (OPTIONAL)

Your motorhome might be equipped with a WIFI antenna (Figure 9-15) to permit access to local unlocked WIFI signals. You can also purchase data packages from the antenna manufacturers. Please see their manuals or websites for more information. Remember. In amplifying any poor signals, the amplified signal will be minimal.



Figure 9-15: OpenRoad Mobile

### KING EXTENDED BOOSTER (OPTIONAL)

The KING Extend boosts and extends personal LTE / Cell signal up to 32x, providing greater coverage and speeds while supporting multiple users. Ideal for RVers, marine enthusiasts, truckers, campers, outdoorsmen, tailgaters, and all mobile adventurers looking for cellular connectivity.



# ELECTRICAL FEATURES

## ELECTRICAL DIAGRAM

35CP

35CP Electrical Floor Plan

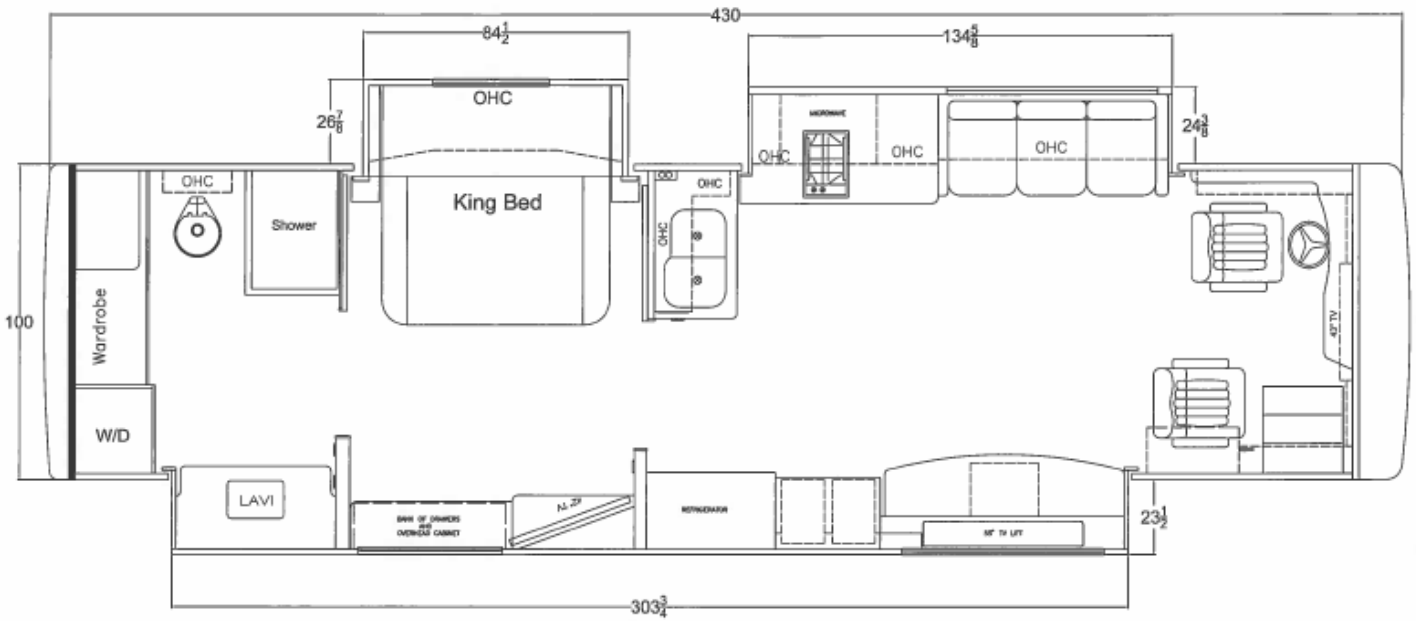

35CP Furnace Duct Layout

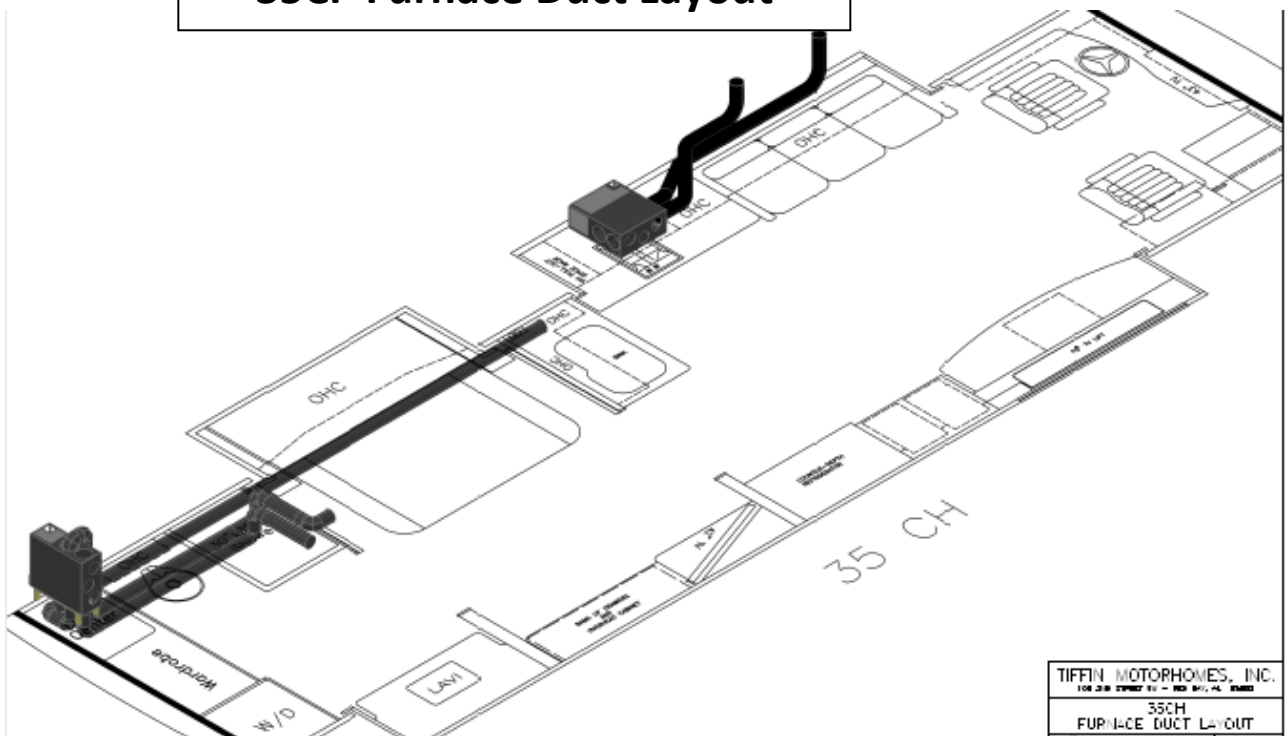

# ELECTRICAL FEATURES

## 35CP 12 Volt Fuse Panel

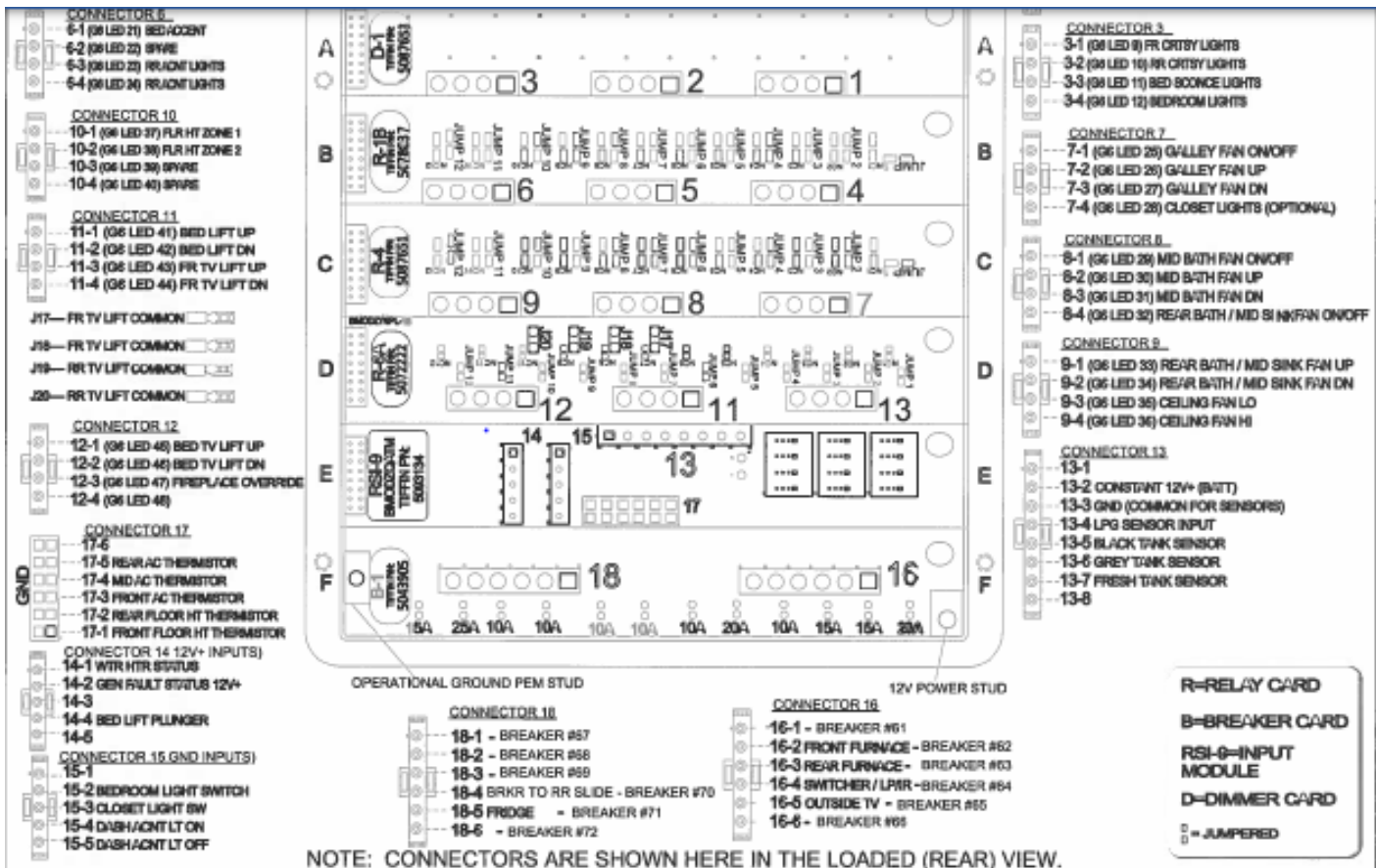

## 35CP Aqua Hot Layout

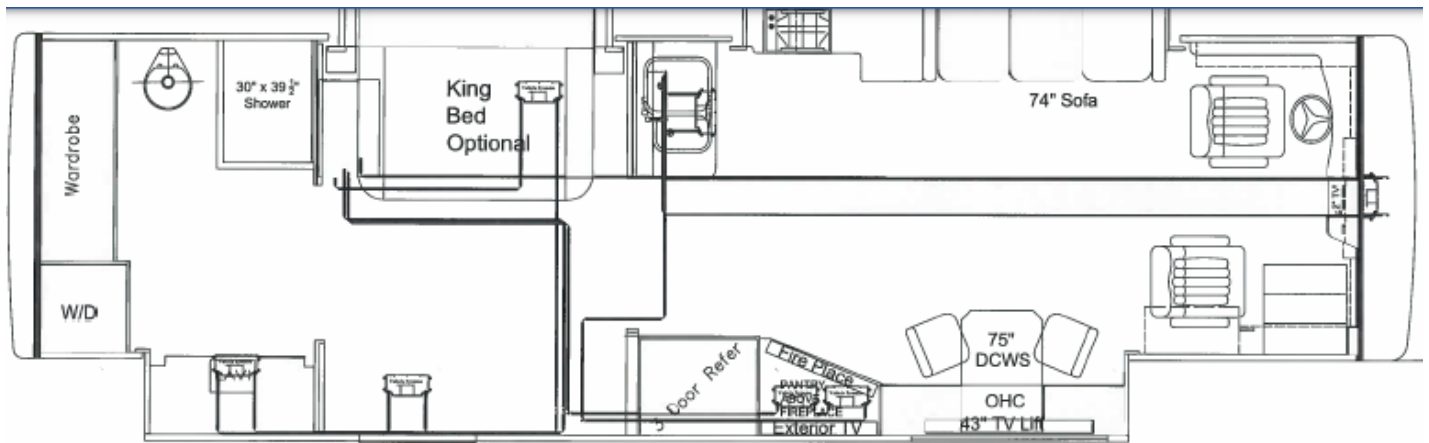

# ELECTRICAL FEATURES

## 35CP LPG Line Layout

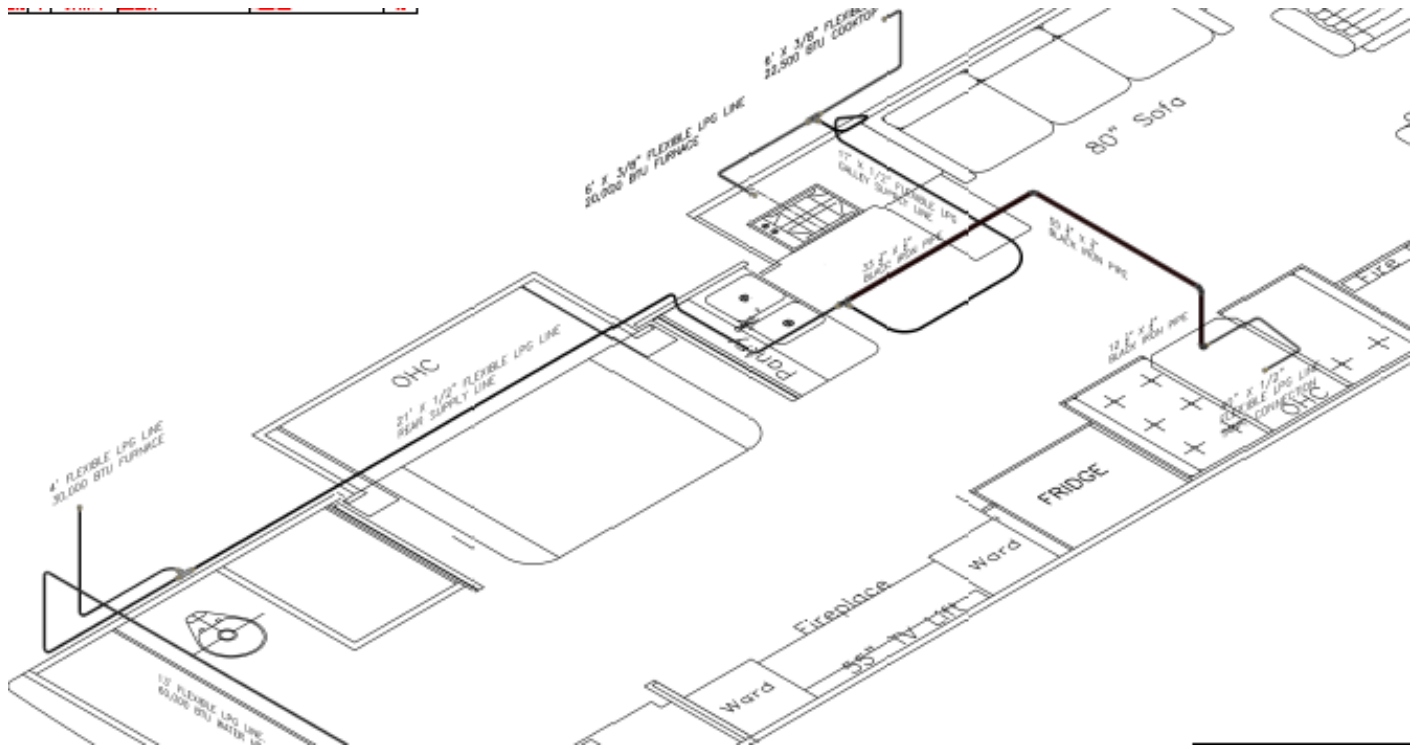

# ELECTRICAL FEATURES

40IP

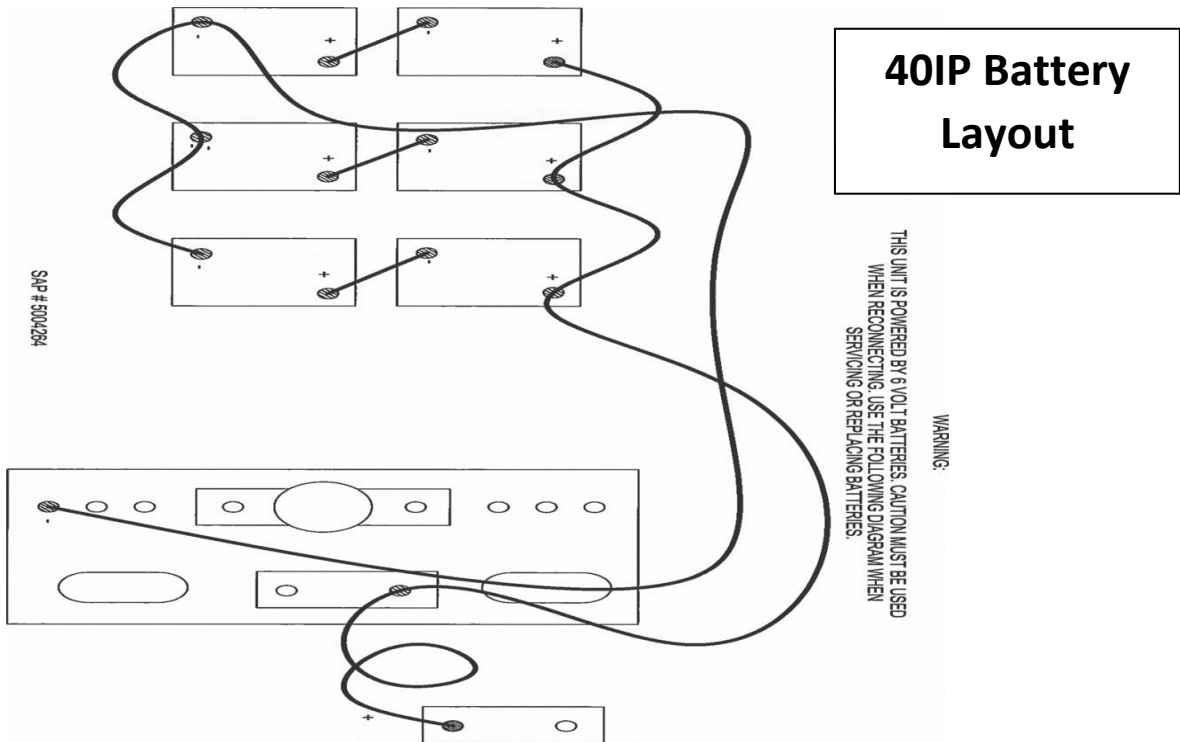

## 40IP 12 Volt Fuse Panel

1. FRONT FURNACE	13. GALLEY VENT
2. REAR FURNACE	14. TOILET VENT
3. SWITCHER	15. REAR BATH VENT
4. CEILING FAN	16. CLOSETLT/MTHERM
5. WATER PUMP	17. FRONT THERMO
6. LP/PANEL LAMP	18. TOILET/REARTHERM
7. CEILING LIGHTS	19. RBTH/RVAN OH LT
8. GALLEY 12V	20. UNUSED
9. BEDROOM LT	21. SLIDE #1
10. UNUSED	22. SLIDE #2
11. MID BATH LT	23. SLIDE #4
12. MACERATOR TOILET	24. TV

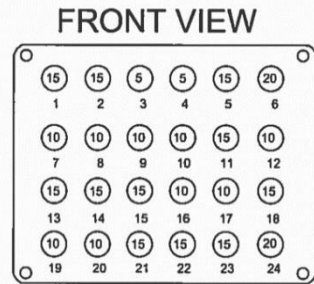

# ELECTRICAL FEATURES

## 40IP Transfer Box

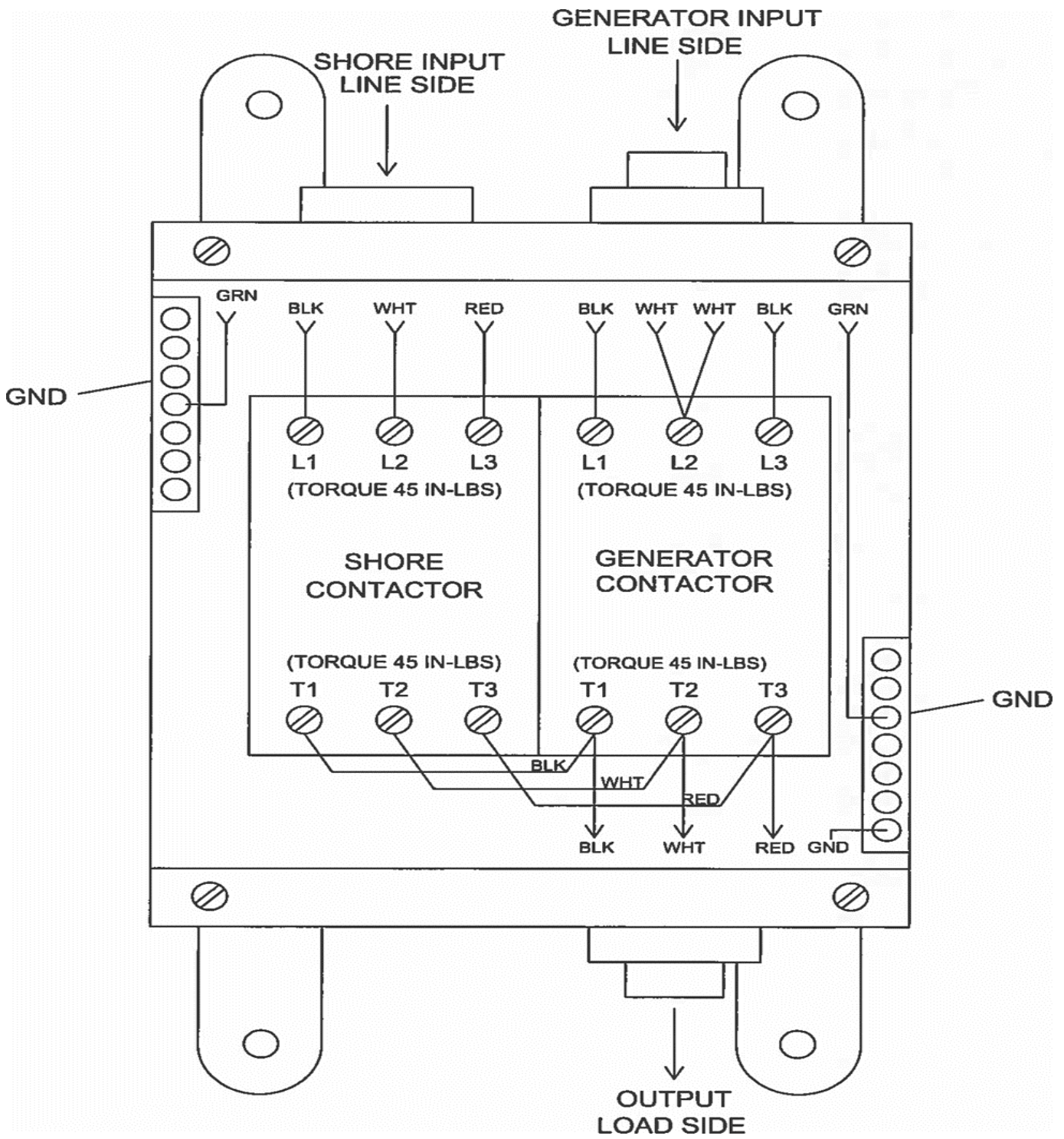



# ELECTRICAL FEATURES

## 40IP Fuse Panel

### CONNECTOR 1



### SOCKETS

### CONNECTOR 2

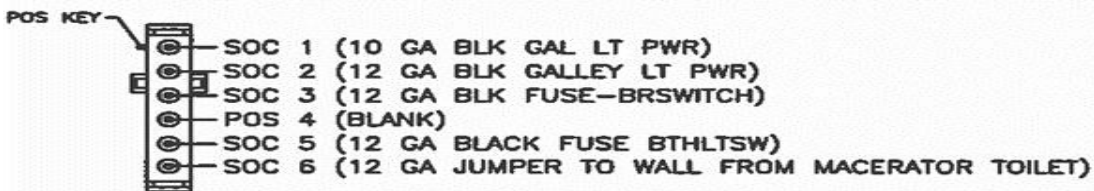

### SOCKETS

### CONNECTOR 3

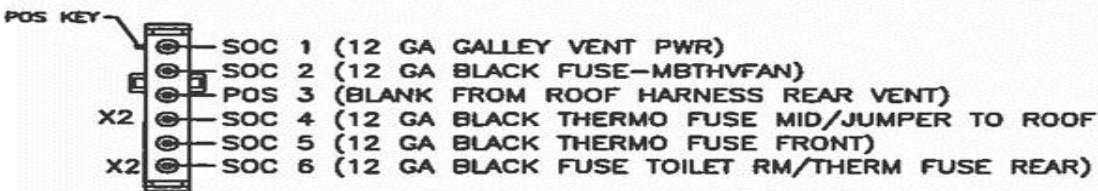

### SOCKETS

### CONNECTOR 4

NOTE: POS 1 CONNECTS TO REAR VANITY OH LIGHT FUSE FROM EN



# ELECTRICAL FEATURES

## 40IP 12 Volt Control Layout

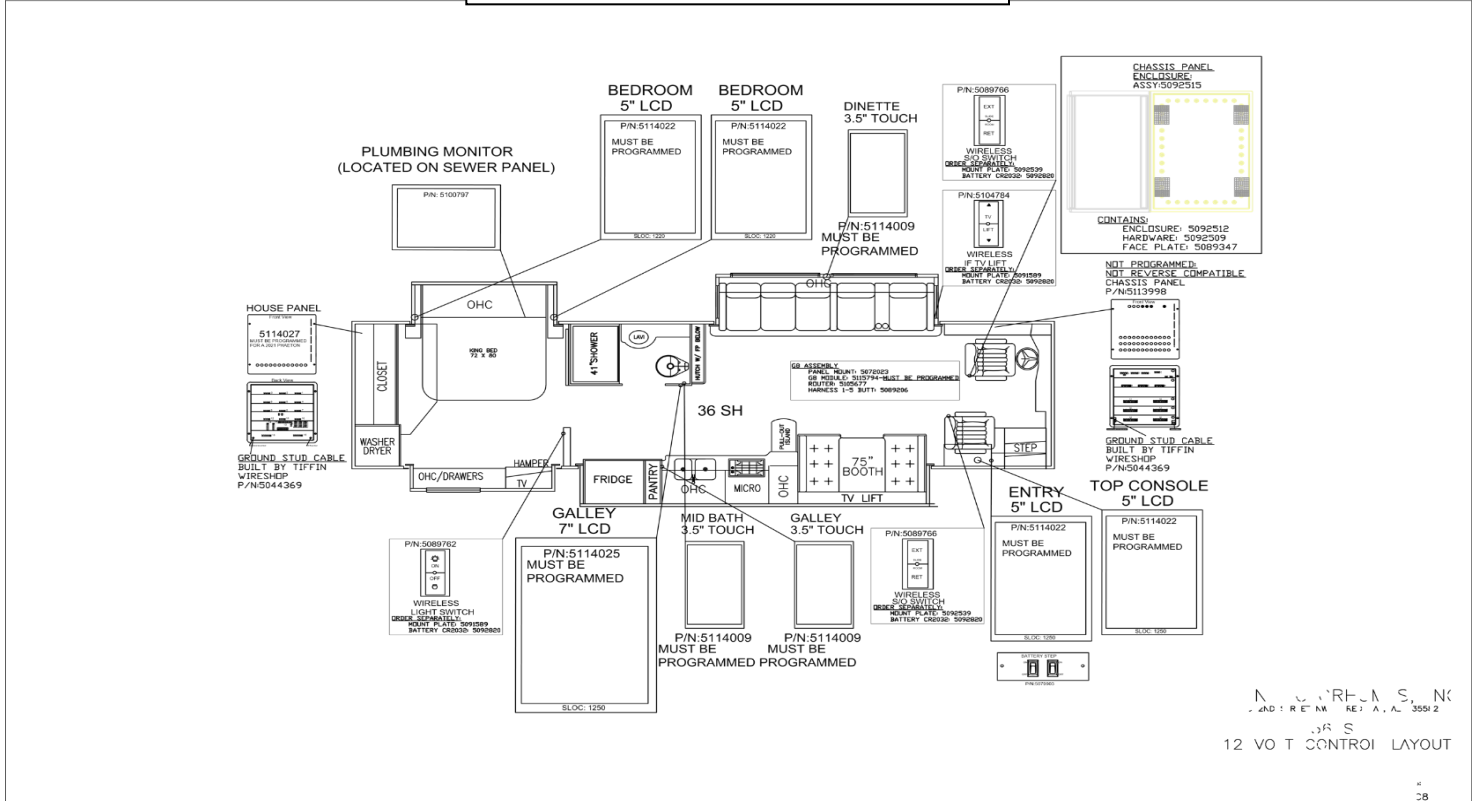

## 40IP Furnace Duct Layout

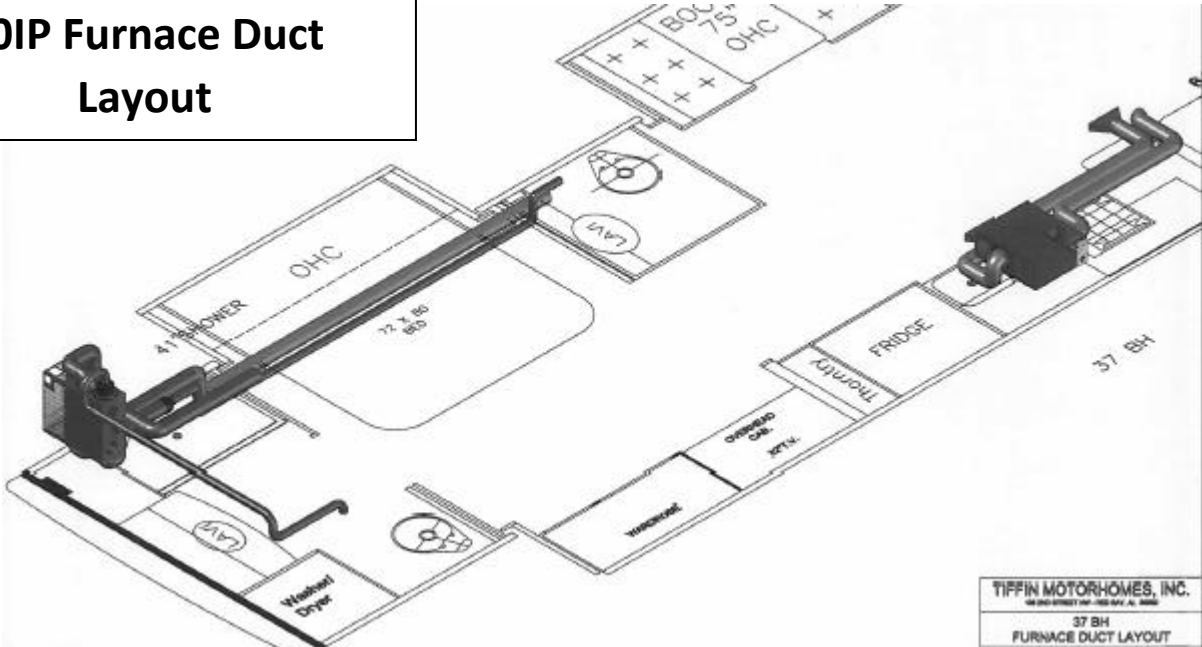

# ELECTRICAL FEATURES

## 40IP Electrical Floor Plan

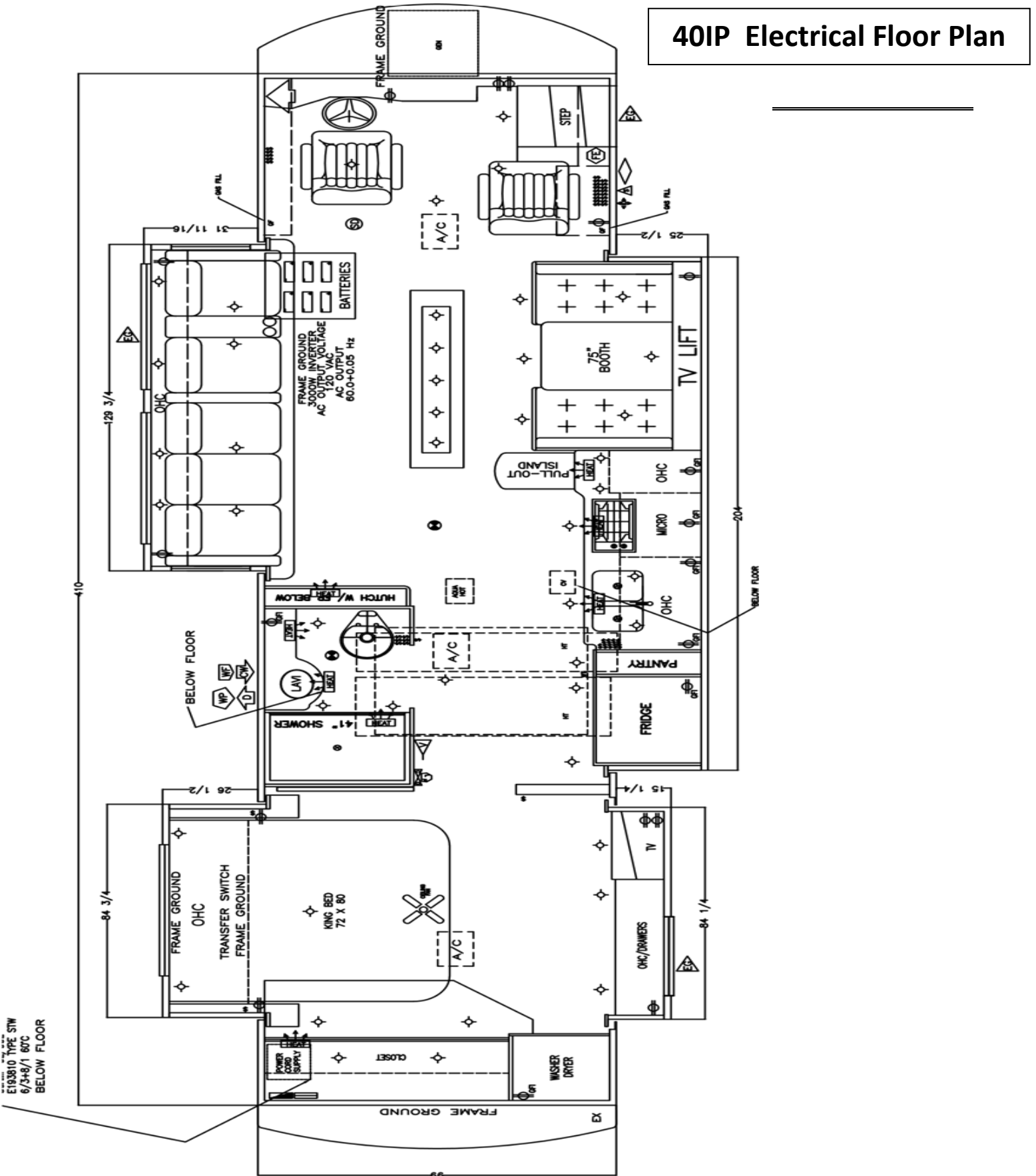

E193810 TYPE SW  
6/24-8/1 80°C  
BELOW FLOOR

# ELECTRICAL FEATURES

45FP

45FP Electrical Floor Plan

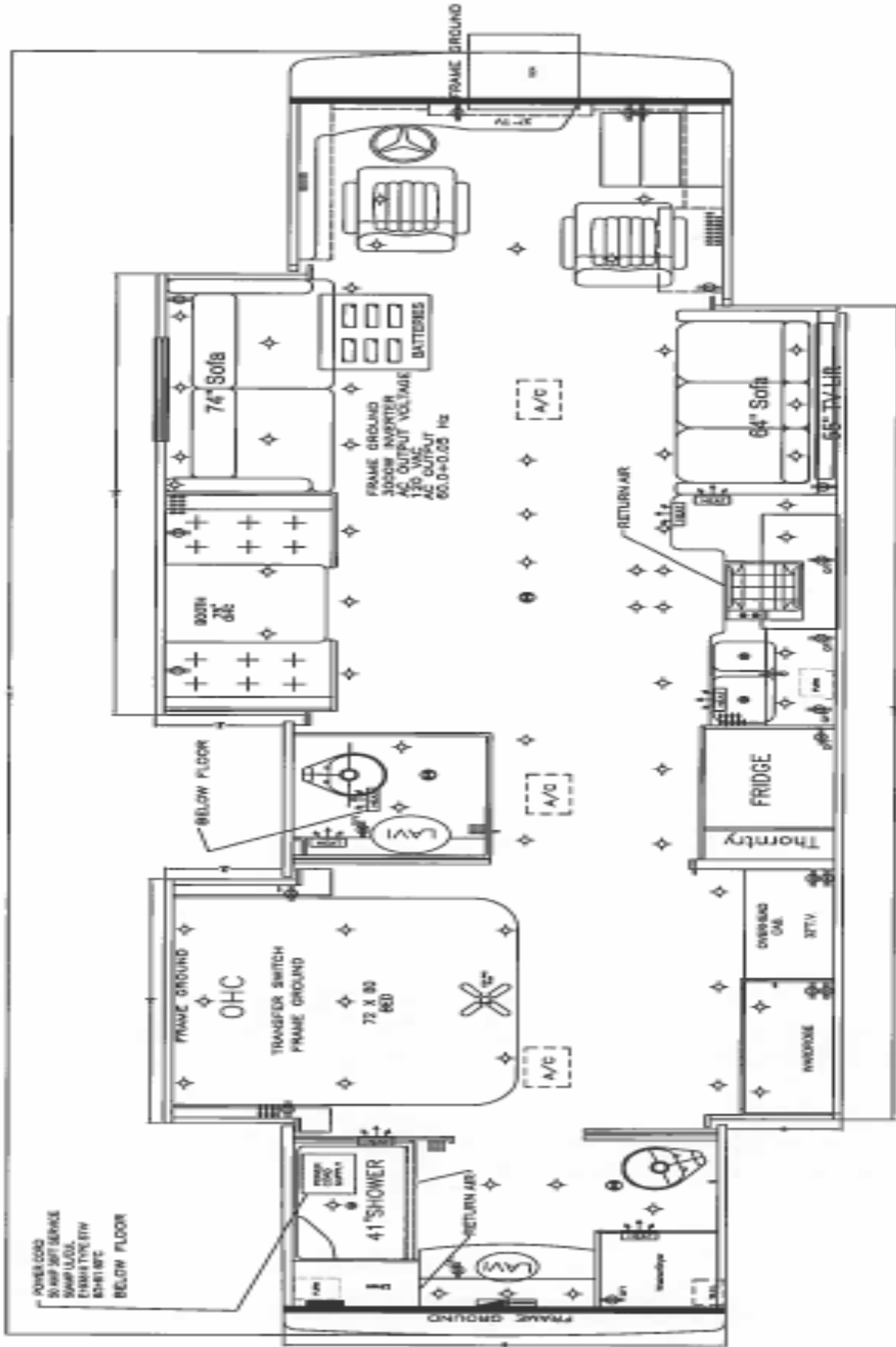

# ELECTRICAL FEATURES

## 45FP LPD Line Layout

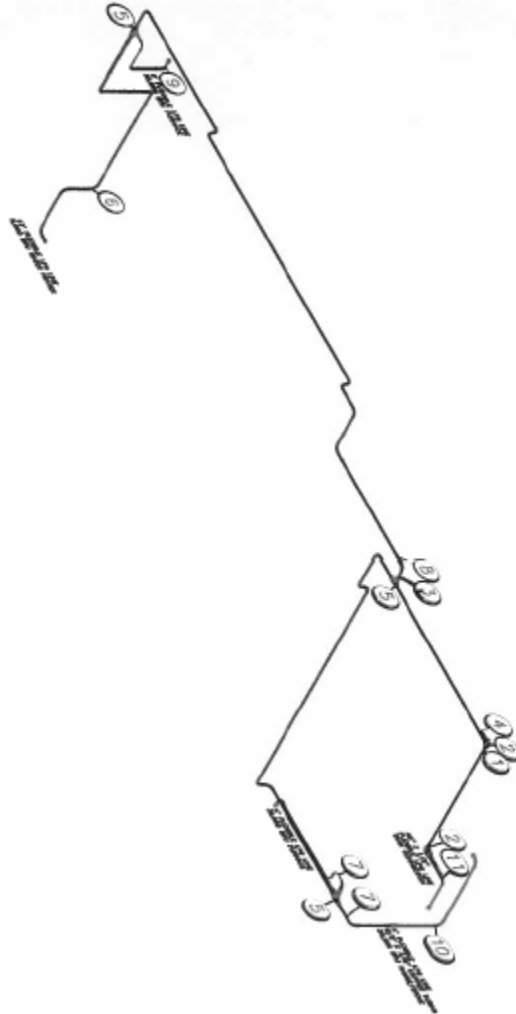

# ELECTRICAL FEATURES

## 45FP Furnace Duct Layout

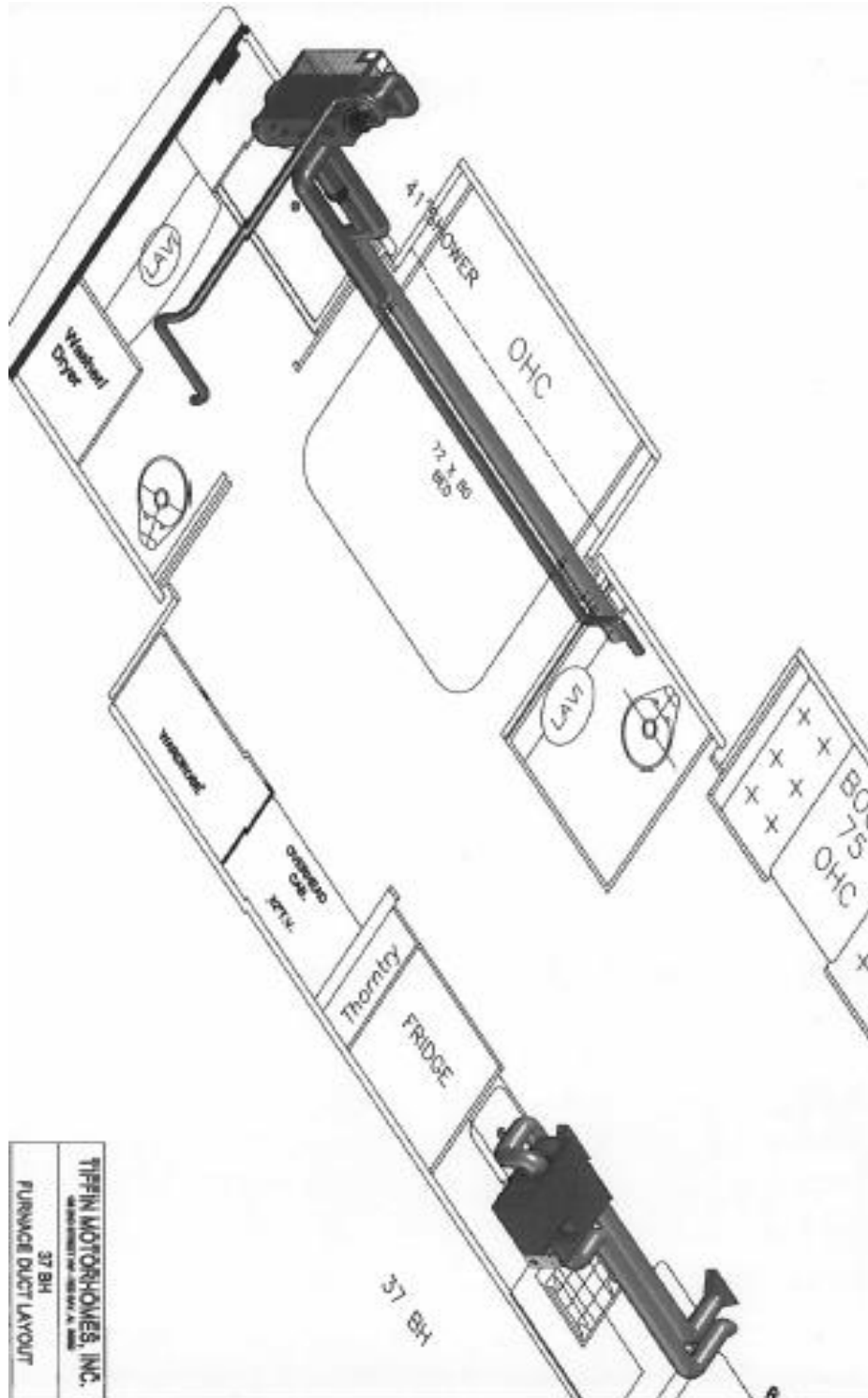



# ELECTRICAL FEATURES

## 45FP Tranter Box

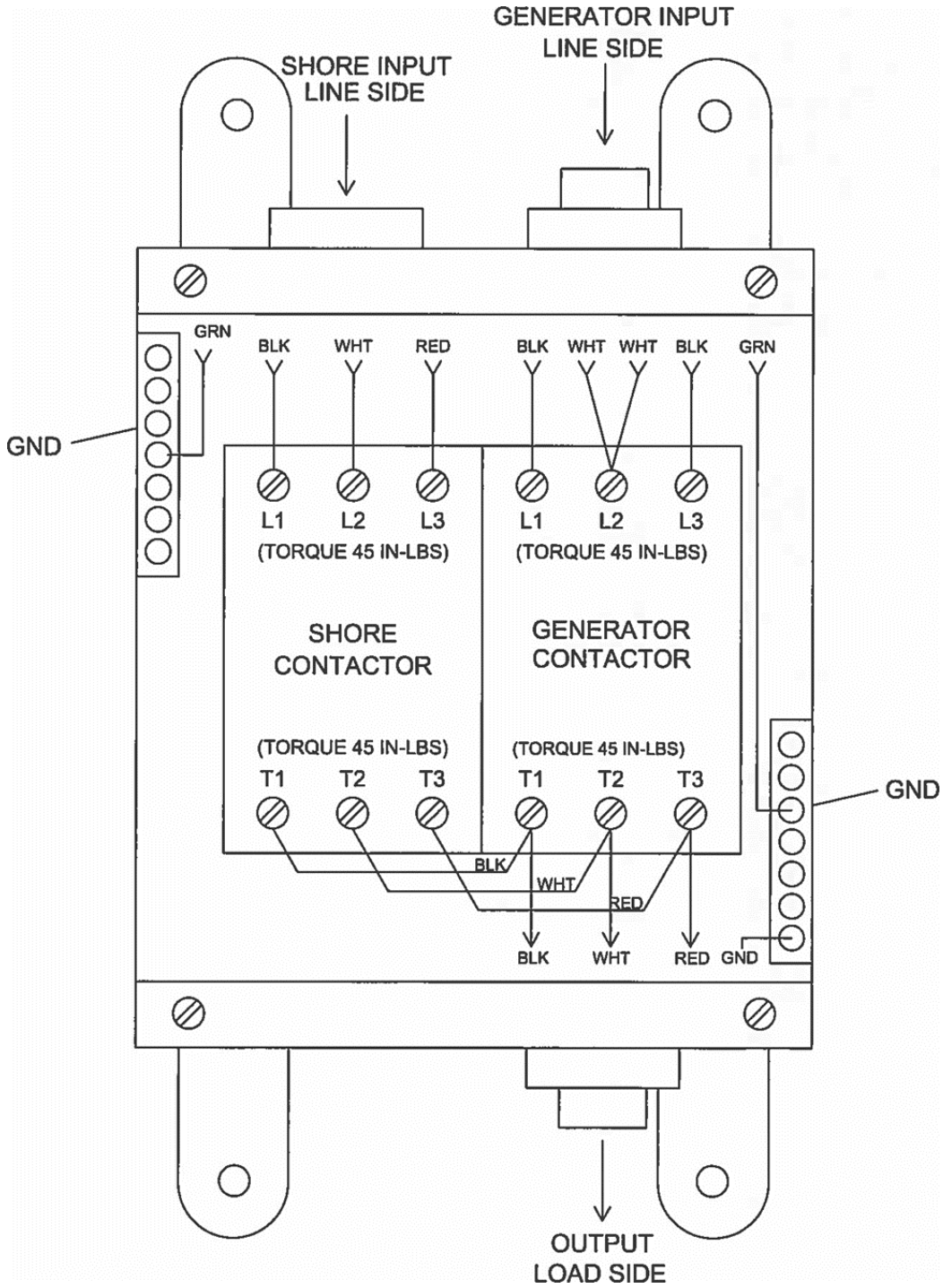

# ELECTRICAL FEATURES

## 45FP Battery Layout

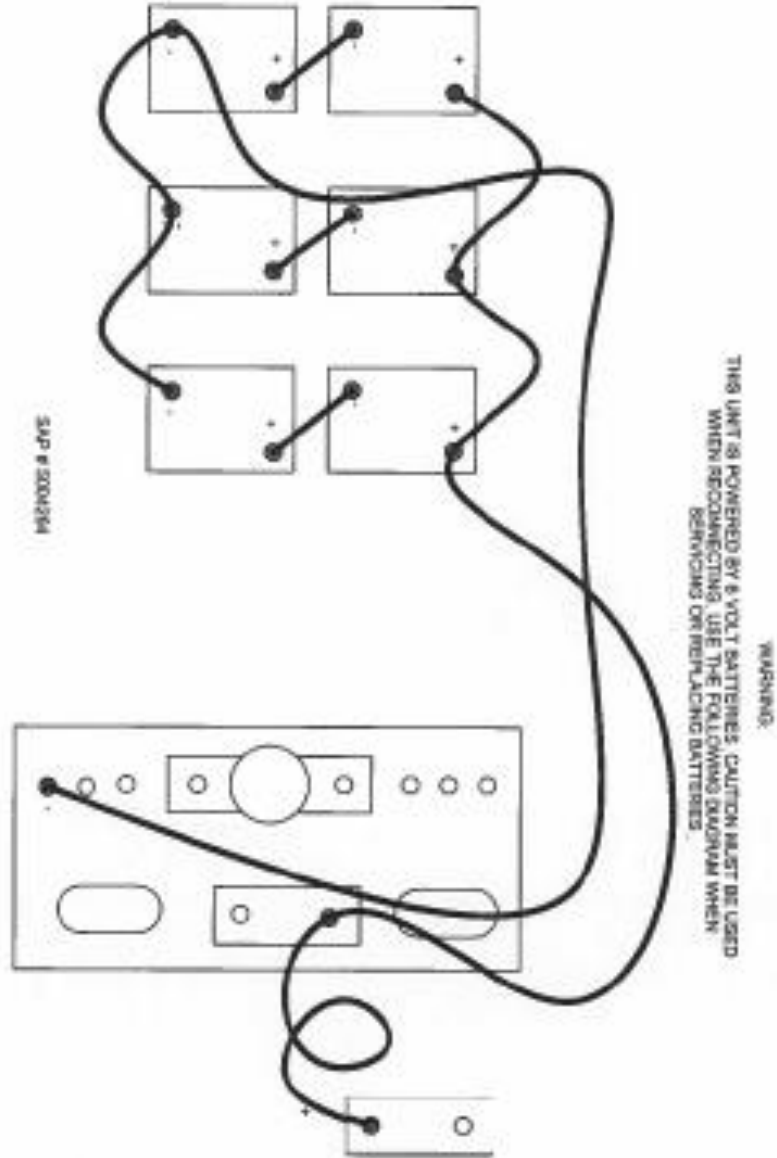

# ELECTRICAL FEATURES

## 45FP

---

### 45FP 12 Volt Fuse Panel

1.	FRONT FURNACE	13	GALLEY VENT
2.	REAR FURNACE	14	TOILET VENT
3.	SWITCHER	15	REAR BATH VENT
4.	CEILING FAN	16	CLOSETLT/MTHERM
5.	WATER PUMP	17	FRONT THERMO
6.	LP/PANEL LAMP	18	TOILET/REARTHERM
7.	CEILING LIGHTS	19	RBTH/RVAN OH LT
8.	GALLEY 12V	20	UNUSED
9.	BEDROOM LT	21	SLIDE #1
10.	UNUSED	22	SLIDE #2
11.	MID BATH LT	23	SLIDE #4
12.	MACERATOR TOILET	24	TV

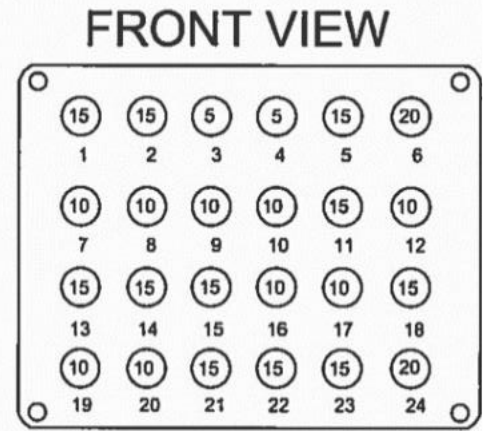

# ELECTRICAL FEATURES

## 45FP Aqua Hot Layout

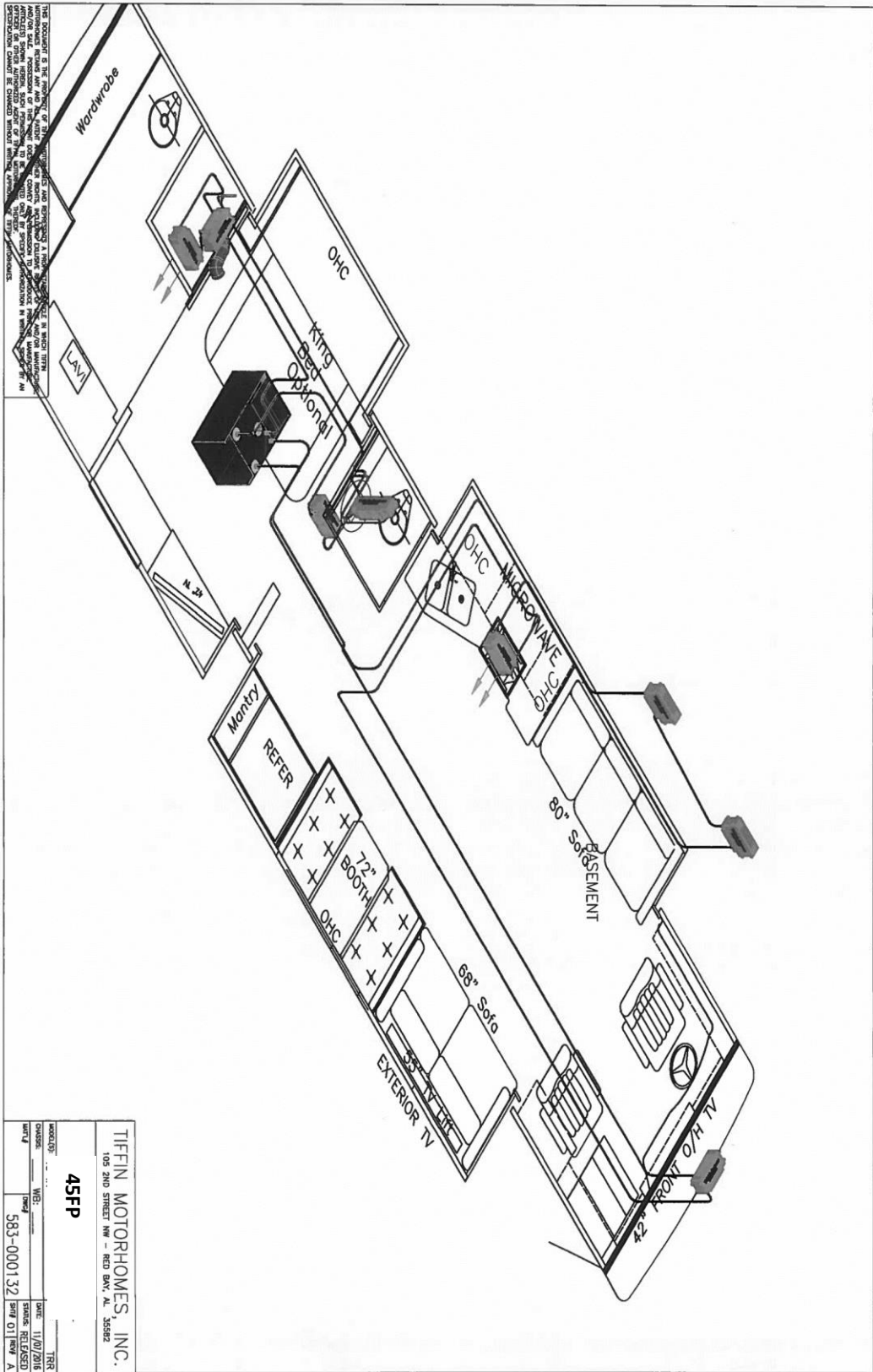

# ELECTRICAL FEATURES

## 45FP Electrical Floor Plan

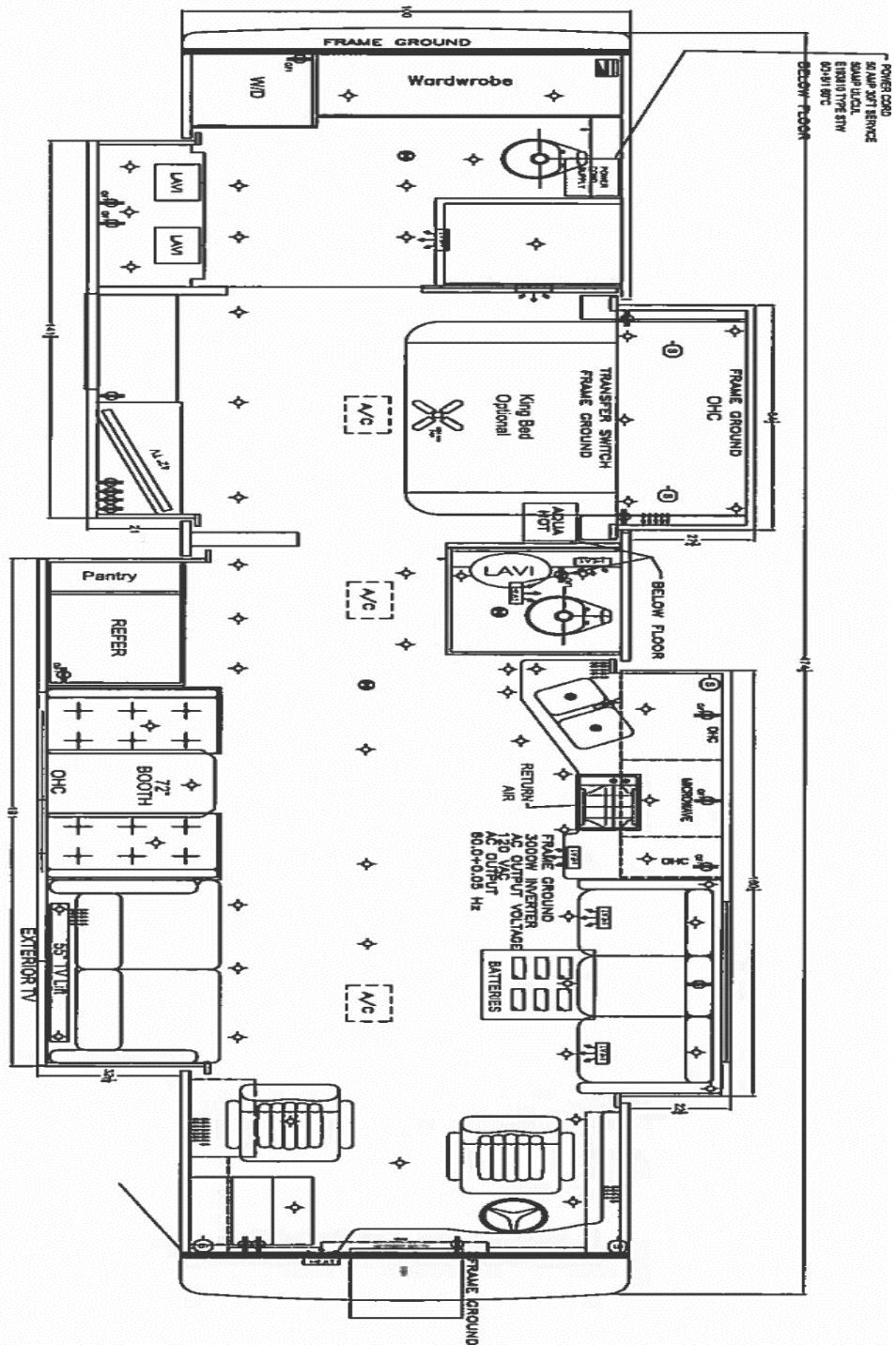

# ELECTRICAL FEATURES

45OPP

45OPP Transfer Box

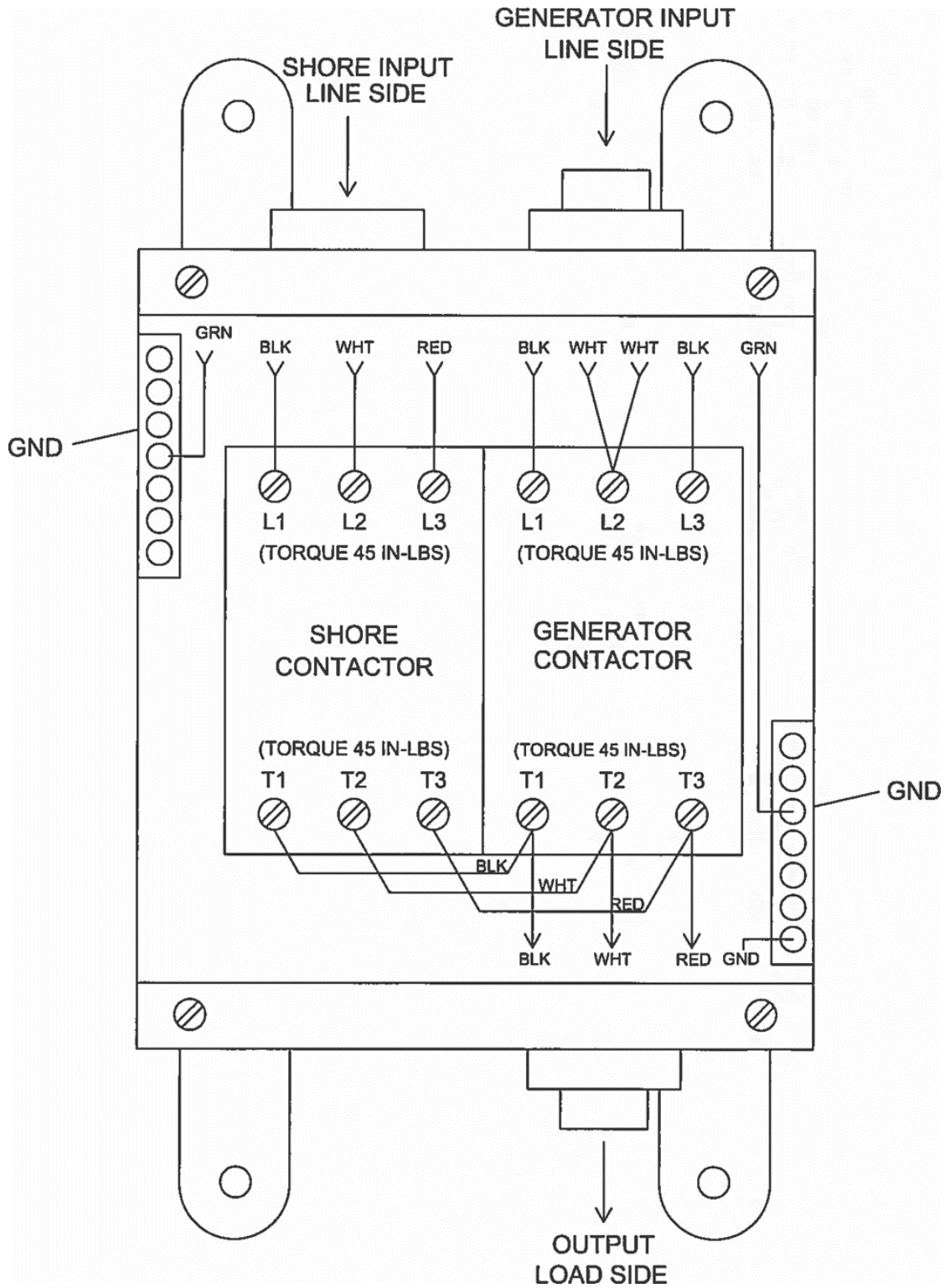



# ELECTRICAL FEATURES

## 450PP Electrical Floor Plan

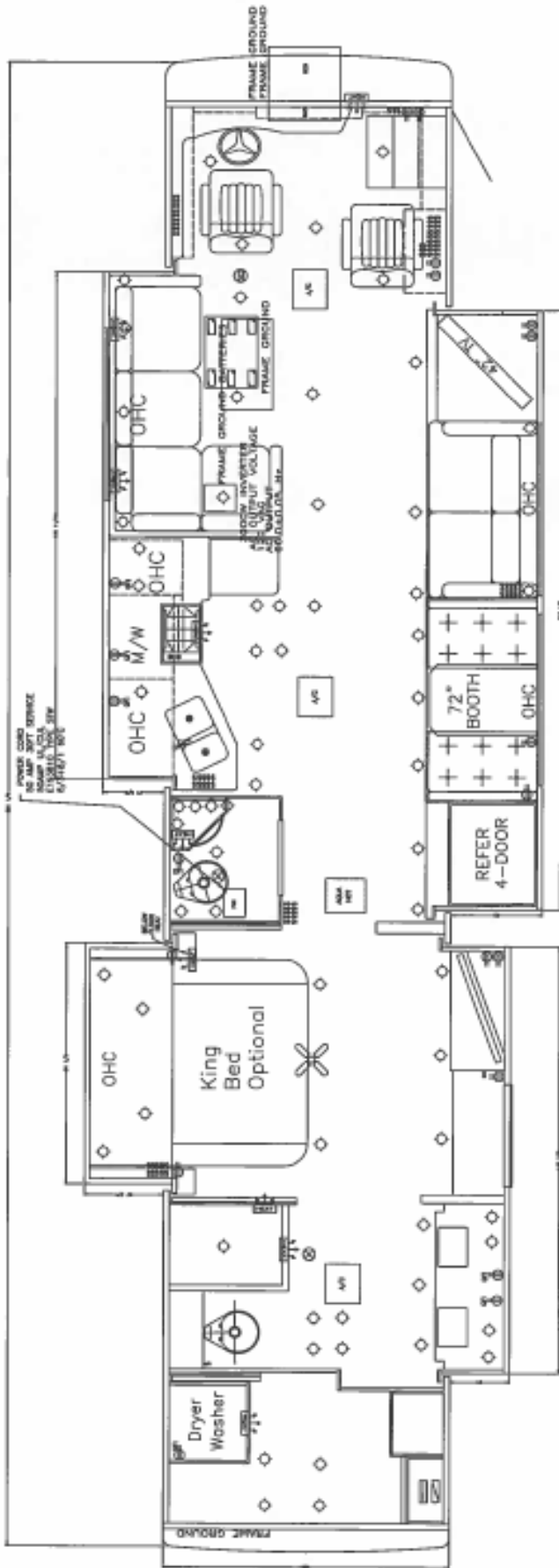

# ELECTRICAL FEATURES

## CONNECTOR 1

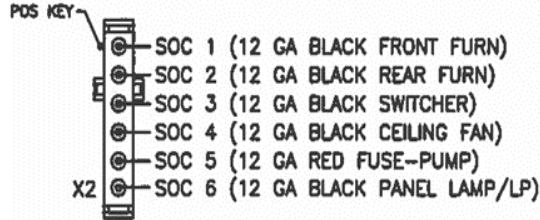

**45OPP Volt Fuse Panel**

## SOCKETS

## CONNECTOR 2

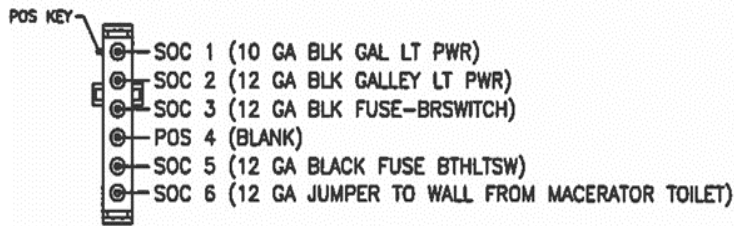

## SOCKETS

## CONNECTOR 3

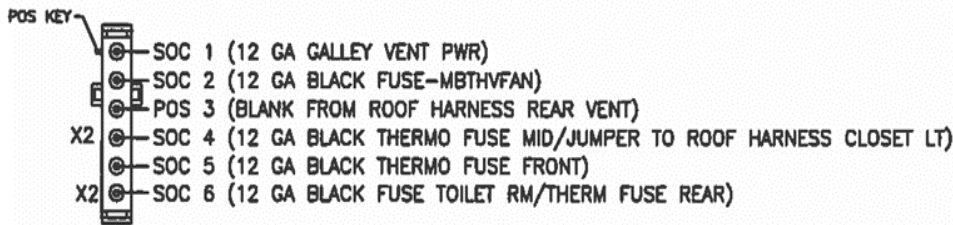

## SOCKETS

## CONNECTOR 4

NOTE: POS 1 CONNECTS TO REAR VANITY OH LIGHT FUSE FROM END WALL

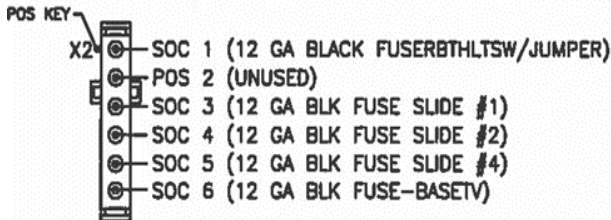

<b>TIFFIN MOTORHOMES, INC.</b>		
105 2ND STREET NW - RED BAY, AL 35582		
<b>45OPP</b>		
<b>12 VOLT FUSE PANEL</b>		
MODEL(S): 44 OH	AUTH:	
CHASSIS:	DATE: 7/20	
MAT'L#	DWG#	STATUS: PCL

# ELECTRICAL FEATURES

## 45OPP 6GA House Panel

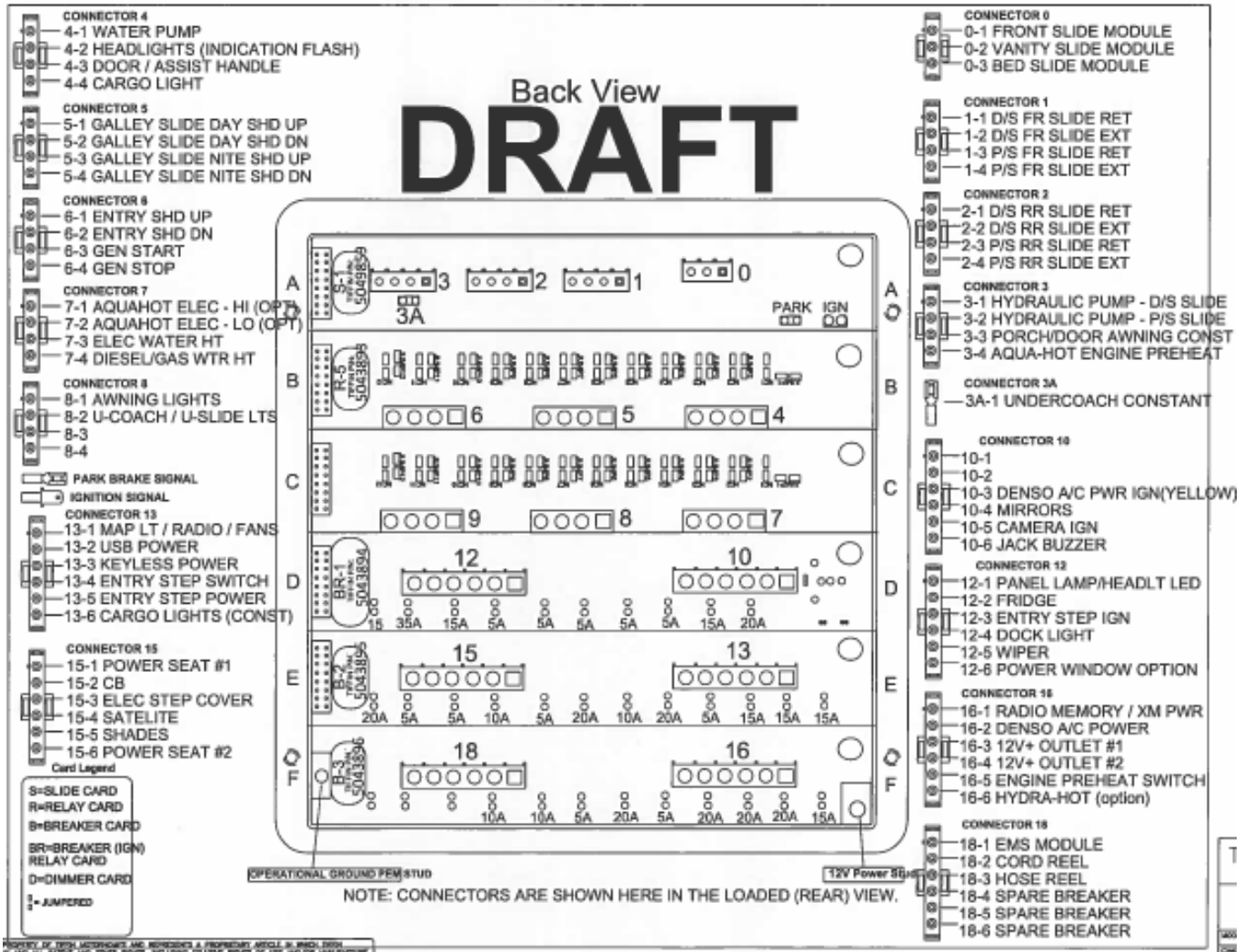

# ELECTRICAL FEATURES

## 45OPP Aqua Hot Layout

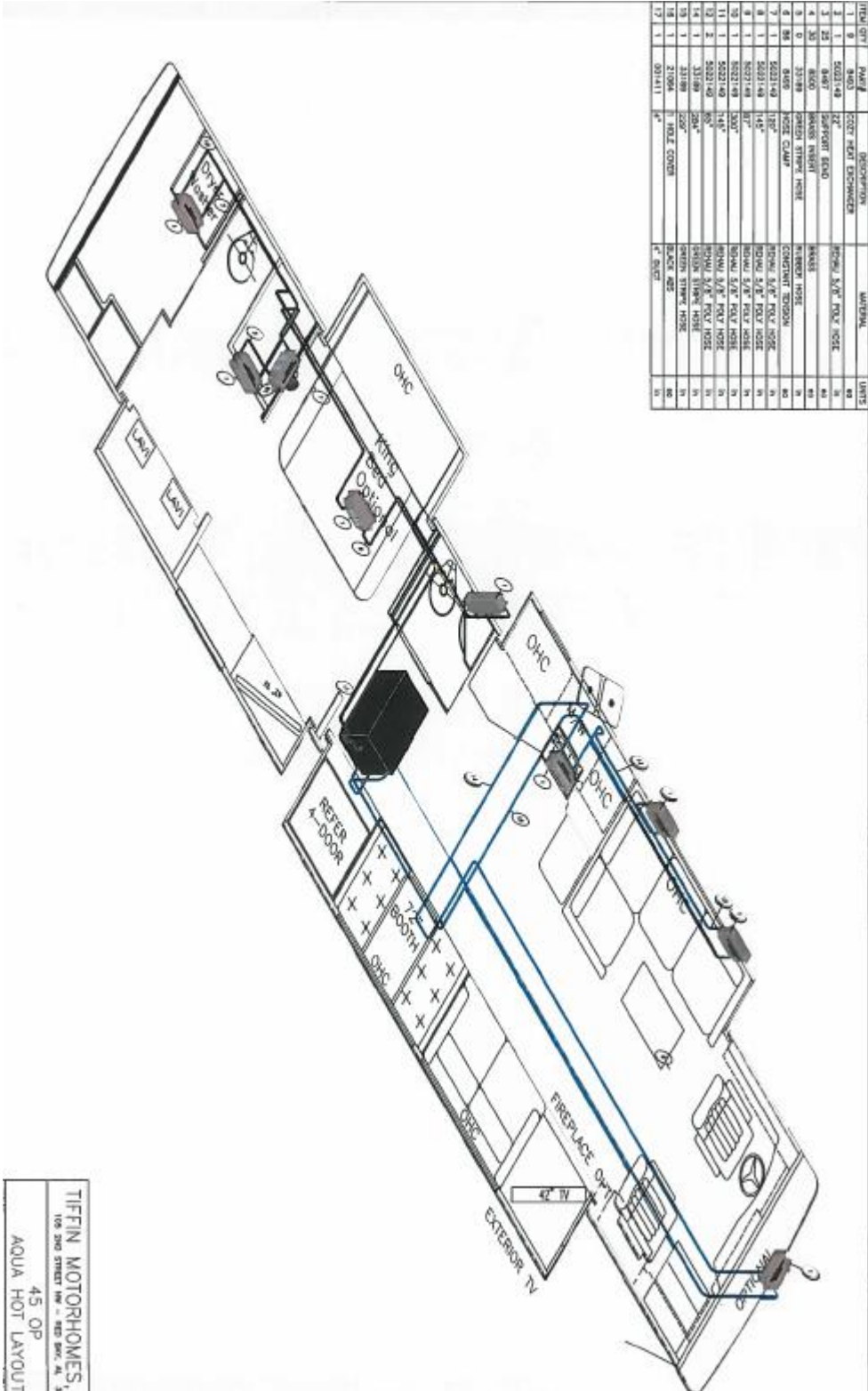

TIFFIN MOTORHOMES  
 100 2ND STREET NW - RED BNC. AL.  
 45 OP  
 AQUA HOT LAYOUT

# ELECTRICAL FEATURES

## 450PP Volt Fuse Panel and Battery Layout.

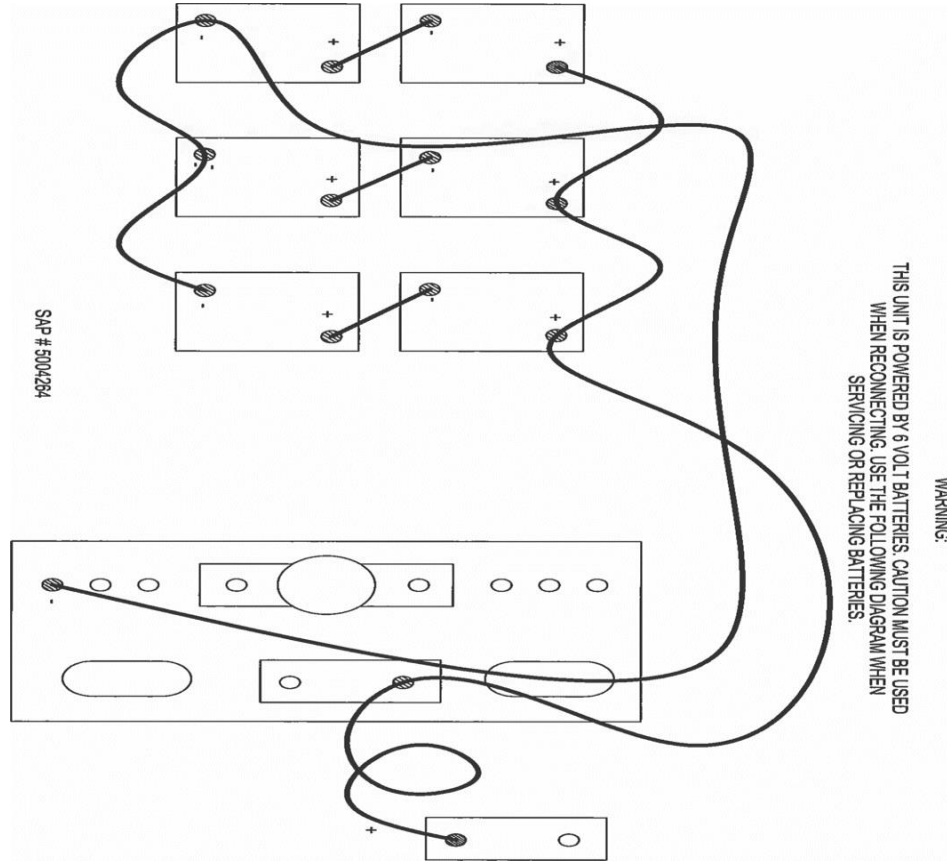

## 450PP 12 Volt Fuse Panel

1. FRONT FURNACE	13 GALLEY VENT
2. REAR FURNACE	14 TOILET VENT
3. SWITCHER	15 REAR BATH VENT
4. CEILING FAN	16 CLOSETLT/MTHERM
5. WATER PUMP	17 FRONT THERMO
6. LP/PANEL LAMP	18 TOILET/REARTHERM
7. CEILING LIGHTS	19 RBTH/RVAN OH LT
8. GALLEY 12V	20 UNUSED
9. BEDROOM LT	21 SLIDE #1
10. UNUSED	22 SLIDE #2
11. MID BATH LT	23 SLIDE #4
12. MACERATOR TOILET	24 TV

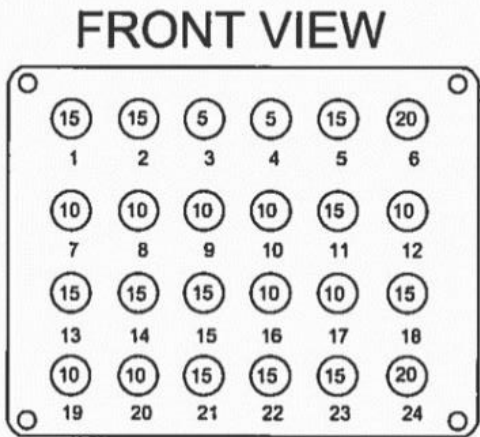

# ALLEGRO BUS

## SLIDE-OUT FEATURES

---

Chapter

10



## SLIDE-OUT FEATURES

### SLIDE-OUT OVERVIEW



## CAUTION

**BEFORE ACTIVATING THE SLIDE-OUT FEATURES**, read the slide-out instruction manual first. The motorhome must be parked, the ignition switch must be in the ON position, and the levelling jacks must be used to level the motorhome **PRIOR** to activating the slide-out features. The emergency foot brake and parking brake must be engaged. Be sure the front driver's seat is moved forward before opening the slide-out.

### GENERAL CONSIDERATIONS

## NOTICE

The slide-out room requires semi-annual inspection to ensure that the slide-out mechanism is properly aligned and functioning correctly. Make sure that this inspection is performed every six months to correct any possible misalignments.

The slide-out-room feature is actuated by a screen on the Spyder Controls System (the third button down on the left of the control) (Figure 10-2 and Figure 10-2). The switch must be manually held down in the desired position (either IN or OUT) to activate the desired action of the slide-out room and continue to be held down until the desired action is concluded.

Switches to operate the front slide-out rooms are also located on the driver's and passenger's seats (Figure 10-1).

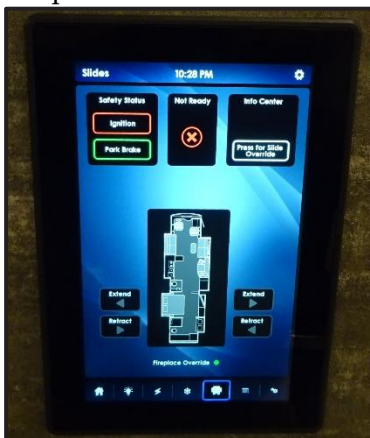

Figure 10-2: Slide-Out Screen on the Spyder Controls System



Figure 10-1: Front Slide-Out Switch

**NOTE:** Releasing the switch before the slide-out is fully extended or retracted will stop the slide-out.

### OPERATING PRECAUTIONS

Before the slide-out-room mechanism is used, make sure the motorhome is parked, and the leveling

## SLIDE-OUT FEATURES

process has been properly completed. Verify that no obstacles (branches, trees, telephone poles, power/water hookups, trash bins, etc.) are within a five-foot space envelope of the slide-out room, to keep from damaging the slide-out room when it is finally deployed.

### NOTICE

**Before attempting to extend the slide-out room, check outside and make sure that there is at least a five-foot clearance around the area where the slide-out room will be extended, and be sure the driver's and passenger's seats are moved to the forward position.**

## EXTENDING THE SLIDE-OUT ROOM

1. Any loose materials or possible obstructions, such as rugs or furniture must be removed from the immediate slide-out room area.
2. Make sure that the motorhome (Figure 10-3) has been leveled, that the battery is fully charged and connected to the electrical system, and that the ignition switch is ON and the engine is running before attempting to use the slide-out features.
3. Verify that there are no obstructions outside, which might interfere with the operation of the slide-out room.
4. Before moving the slide-out room in either direction, make sure that the driver's and passenger's chairs are moved forward into the driving area as far as possible and locked into position.
5. Make sure the parking brake is engaged.
6. Push EXTEND on the Spyder Controls System, and allow the slide-out room to go to its fully extended position. When fully extended, release the switch.



Figure 10-3: Extend and Retract Slide-Out Room

---

**NOTE:** The front slide-outs can also be operated by pressing the buttons located on the sides of the seats.

---

## SLIDE-OUT FEATURES

### Retracting the Slide-Out Room

Before attempting to move the motorhome, the slide-out room must be fully retracted. Make sure the engine is running.

1. Verify that the 12 VDC system is fully charged and connected to the electrical system.
2. Make sure all personal equipment and any children are away from the slide-out.
3. Make sure all cabinet doors around the slide-out areas are closed.
4. Push RETRACT on the Spyder Controls System, and allow the slide-out room to go to its fully retracted position.

---

**NOTE:** The front slide-outs can also be operated by pressing the buttons located on the sides of the seats.

---

5. Release the switch (this locks the room into position).

### NOTICE

If the slide-out room does not move when the switch is depressed, check the following:

- Make sure the engine is running.
- Make sure the park brake is engaged.
- Make sure the battery is fully charged and connected.
- Make sure the slide-out breakers haven't been "tripped." These are located in the storage box with the inverter or converter.
- Make sure the power bed is in the UP position before retracting bedroom or vanity slide. Slides will not retract with the power bed in the DOWN position.

## SLIDE-OUT FEATURES

### EMERGENCY SLIDE-OUT ROOM CONTROL OVERRIDE

If the switches for the slide-out rooms become disabled in the cabin of the motorhome, use the emergency override button for all slide-outs (Figure 10-4) that is located in the front driver's side compartment with the fuses for the motorhome. This override switch operates all slide-outs simultaneously. To retract or extend the slide-outs, a round dowel or cylinder (for example: barrel of a ballpoint pen) must be inserted in the holes marked RET or EXT.

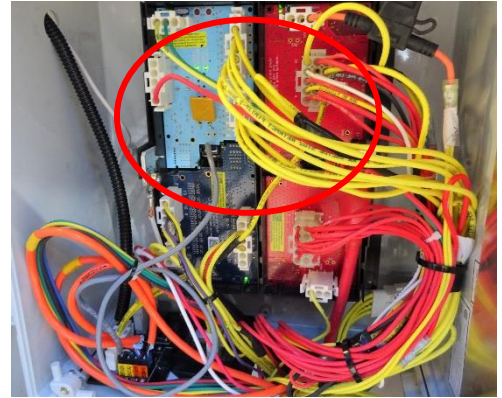

Figure 10-4: Location of Slide-Out Room Control Override

# ALLEGRO BUS

## EXTERIOR FEATURES

---

Chapter

11

## EXTERIOR FEATURES

### EXTERIOR SIDES

The sides of your motorhome (Figure 11-1) and the end caps are made of gel-coated fiberglass.



Figure 11-1: Exterior Sides

To clean these fiberglass surfaces, use only warm water and a mild cleanser; gently wash with soft cloths.

**Use of stiff bristle brushes or other harsh abrasives might cause scratches on the fiberglass surfaces.**

---

**NOTE:** Tiffin Motor Homes is NOT responsible for the weathering and/or oxidation of gel-coated surfaces.

---

Spacious storage compartments are located on the exterior sides of your motorhome. These external compartments provide ample additional space for your belongings while you are traveling. When stowing materials in these storage compartments, try to “balance” the resultant weight load from front to rear and from side-to-side. This will keep the center of gravity of the motorhome essentially unchanged and should not adversely affect the handling characteristics of the motorhome when it is in motion.



## EXTERIOR FEATURES

### ELECTRIC SLIDE TRAY (OPTIONAL)

There is an option for one or two electric slide trays (Figure 11-2) in the cargo bay.

To operate, open the cargo door housing the electric slide tray. Locate the switch (Figure 11-3) on the inside of the cargo door. Use the OUT function on the switch to extend the slide tray from the coach. The IN function allows the electric slide tray to retract.

---

**NOTE:** The electric slide tray can be operated from the driver and passenger side of the coach.

---



Figure 11-2: Extended Electric Cargo Tray



Figure 11-3: Electric Slide Tray Switch on Cargo Door

### ELECTRIC SLIDE WITH KITCHEN (OPTIONAL)

Your Allegro Bus may have an optional external kitchen which is located on one of the slides in storage area of the Bus. Please read the manufactures manual before using the kitchen.



the

### SECURITY LIGHTS

On the motorhome, exterior security lights (Figure 11-4) are standard features.

A light is installed on the passenger side of the coach to help light that side of the Allegro Bus for added protection.

This light can serve as a “porch light” when the motorhome is parked and the awning is deployed so that various activities (e.g., sitting outside, grilling, visiting) at dusk and later can be enjoyed by the motorhome owners and their guests.



Figure 11-4: Exterior Security Light

## EXTERIOR FEATURES

### ROOF & LADDER (OPTIONAL)

The Allegro Bus is manufactured with a fiberglass roof accessed by an optional ladder. Proper care and routine maintenance of your roof will ensure many years of trouble-free performance.



Figure 11-5: Roof Ladder

The (Optional) On-the-Go Ladder is a fully adjustable and collapsible ladder with safety locks at each rung for extra security. The Ladder is designed to be used with the OEM-installed On the Go Receiver, but can be used without the Receiver as a lean-to ladder.



Additional information about this product can be obtained from [lci1.com/support](http://lci1.com/support) or by using the LippertNOW app. Replacement kits can be ordered from <https://store.lci1.com/> or by using the LippertNOW app.

In the event you purchase a coach that did not receive the ladder option, You can order direct from Lippert Components. Aftermarket Part# 2021126697



### CAUTION

Do not exceed the maximum rating of the ladder (i.e., 200 pound load limit).

Do not attempt to walk on the roof either while it is wet or when condensation is present from the air conditioning system as the roof surface will be quite slippery.



### CAUTION

REMOVE AND STOW THE LADDER PRIOR TO TRAVEL. FAILURE TO PROPERLY REMOVE AND STOW THE LADDER COULD RESULT IN PERSONAL INJURY OR PROPERTY DAMAGE.

# EXTERIOR FEATURES

## ELECTRIC STEPS

The Allegro Bus is equipped with electric door steps (Figure 11-6).



Figure 11-6: Electric Steps



Figure 11-7: Entrance Step Switch

The switch (Figure 11-7) to operate these steps is located in the door stairwell. When the power switch for the steps is in the ON position, open the door and the steps will automatically extend.

## USING THE ELECTRICAL, DOUBLE-ENTRANCE, DOOR STEPS

### With the step switch turned ON:

- Close the door. The step will retract and lock into the UP position.
- Open the door. The step will retract and lock into the DOWN position.
- Turn the vehicle ignition switch OFF and open the door. The step will extend and lock in the DOWN position.

### With the step switch turned OFF:

- The step will remain in an extended position when the door is closed. Turning OFF the power with the step retracted will hold the step in a retracted position, as well.

## EXTERIOR FEATURES

- With the step extended, close the entrance door. Turn the vehicle ignition switch ON. The ignition override system will go into effect and the step will automatically retract.

---

**NOTE:** This feature is operational only the first time the door is opened after the vehicle ignition switch is turned OFF. When the ignition switch is ON, the step will always activate with the door movement, regardless of the position of the step power switch.

---

Other exterior features include optional power-assisted awnings (patio awning, door awning, or both). If available, they can be controlled from the switch console located in the stairwell of the motorhome.

## EXTERIOR FEATURES



### CAUTION

DO NOT travel with the steps or awnings in the extended position. If the motorhome is driven with the steps or awnings in the extended position, there is the possibility of causing major damage to the steps or awnings, and to the motorhome.

### NOTICE

If the door is opened and closed without allowing the step to extend fully and lock in the DOWN position, the step will retract and lock in the UP position. When the door is re-opened, the step will not extend. The power switch must be turned ON for the step to extend.



### CAUTION

Always be sure to “look before you leap!” When opening the entrance door from the inside, be sure that the step has fully deployed before trying to step outside to avoid falling and possible injury.

## EXTERIOR FEATURES

### MIRRORS WITH BSM



Figure 11-8: Mirror With BSMO

This motorhome is equipped with remote-controlled, exterior rear view mirrors. The mirror may be equipped with Blind Side Monitoring System, which is activated when a vehicle is beside your motorhome. (Red Oval) (Figure 11-8).

Always adjust the mirrors for maximum rear visibility before driving. If another driver is to drive, be sure the mirrors are readjusted to accommodate the second driver.

The mirrors are adjusted by using the multi-directional switch (Figure 11-89) located on the dashboard. Select the mirror to be adjusted by pointing the arrow in the direction of that mirror.

Move the control in the direction of movement desired to obtain the best view for that mirror. The adjustment control moves the top half of both mirrors. The bottom half of each mirror is convex and is adjusted manually.

Detailed instructions for these manual adjustments can be found in the manufacturer's literature available in the Owner's Information Package. However, this brief overview of mirror adjustment can begin the process: The top portion of the mirror must be adjusted horizontally so that you can see your own motorhome in the one-inch surface closest to the motorhome. The remaining portion of the mirror now enables you to see the road behind you. The mirror must be adjusted vertically so that you can see the rear bumper on the bottom of the plane portion of the mirror.

The convex mirrors must be adjusted horizontally so that you can see your own motorhome in 1/3rd of the mirror. These convex mirrors must then be adjusted vertically to allow you to see any other vehicles alongside your motorhome.

These mirrors also contain heating elements to defog or de-ice the mirror glass during cold weather operation. The red ON/OFF switch for this feature is located by the adjustment control. Further adjustment of the mirror might be necessary at the swivel portion of the mirror arm.



Figure 11-8: Mirror Adjustment Controls

## NOTICE

**Objects viewed in convex mirrors appear smaller and farther away than they actually are.**



## EXTERIOR FEATURES

### OUTSIDE REFRIGERATOR ACCESS



On the exterior of the motorhome, a hinged door with latch is provided to allow convenient access to the back of your kitchen's refrigerator for servicing.

Figure 11-9: Outside Refrigerator Access

# ALLEGRO BUS

## INTERIOR FEATURES

---

Chapter

12

## INTERIOR FEATURES

### BEDSPREAD

As a furnished part of the bedroom suite, a bedspread with matching pillow accessories (Figure 12-1) is included with the motorhome.

The bedspread and pillow shams are “for dry-cleaning only.” As the bedspread was made with materials treated for stain resistance, dry-cleaning will prolong the life of these materials. The curtains in the bedroom are color-coordinated with the bedspread and accessories to provide a pleasing décor for the bedroom area.



Figure 12-1: Bedroom Décor

### ELEVATED BEDS CAUTION.



## CAUTION

- **250 lbs. Max. load capacity**
- **Failure to comply with the load capacity could cause bed failure which may result in injury.**
- **Bed (s) must be stowed in the up position during travel.**
- **Elevated beds may present a fall hazard which may result in injury. Please consult the Owner's Manual for more information regarding elevated beds and the use of bed rails.**

Standard Elevated Beds – Various Tiffin products are equipped with standard built-in elevated beds or bed loft areas. These beds can be upwards of 4 to 5 feet above the floor level and are often enclosed on one, two, or three sides and sometimes even partially on a fourth side. Because there are so many potential users and different types of elevated bed designs, elevated beds are not equipped with bed rails.

Use of Bed Rails – We feel that you, as the customer, are best equipped to determine if a bed rail system is necessary or best for you based on your intended uses, the actual users of the elevated beds, and the comfort level of the users. For those customers who would prefer using an elevated bed with a bed rail, there are numerous bed rail styles, sizes, heights, and designs available, even in the style of bumpers, which can be purchased at various retail locations and/or on the internet.

When installing a bed rail please make sure that you follow the manufacturer's installation instructions carefully and that you take in to account the size and height of the mattress (either originally installed by Tiffin or later replaced by you) so that the rails are the appropriate height above the top of the mattress. This is important because residential mattresses differ in size from the RV mattresses originally installed by Tiffin. **Please also make sure that the bed rail you select allows for adequate room to get in and out of the elevated bed after installation, especially in the event of an emergency.**

#### Tips for Safe Usage:

- Please use sound judgment when allowing children to sleep in any style of elevated bed. Generally, it is not suitable for children under the age of 6 to sleep in an elevated bed or bed loft area.
- Discuss proper usage of any elevated bed/electric bed lift system with your children and make sure they are supervised if playing in the bedroom/sleeping area of the trailer with elevated beds. Please do not allow horseplay on or under the elevated beds and no items such as hooks, belts, jump ropes, or towels should hang from any part of the elevated bed.

## INTERIOR FEATURES

- Place a night light in the bedroom/sleeping area so users can see at night when getting in and out of the beds.

No more than one person should be in an elevated bed at once and make sure you follow the weight restrictions posted on the warning label near the beds.

### FLOORING

Porcelain ceramic tile (Figure 12-2 and Figure 12-3) is standard throughout the motorhome with the exception of the slide-out rooms, and the bedrooms, which are carpeted. For routine cleaning, sweeping or vacuuming the floor would be sufficient. If more thorough cleaning is warranted, the flooring can be cleaned with a damp mop and water. For more stubborn stains, a mixture of soap-free household cleaner (e.g., vinegar, ammonia, or comparable products) and water can be used.



Figure 12-2: Tuscan Sea Salt Flooring (Standard)



Figure 12-3: Vicinity White Flooring

Do not saturate the floor surfaces with water, as this could damage the flooring substrate. Do not use any abrasives (cleansers, scouring pads, and the like) as they can scratch or mar the flooring surfaces and might cause damage to the flooring.

### SAFE

The Allegro Bus contains a safe (Figure 12-4). This safe can be used to hold valuables, important documents, and other items you might want to protect during your travels. The safe is located in the rear bedroom closet.



Figure 12-4: Safe

### REAR FIREPLACE

To operate the rear fireplace (Figure 12-5), Fireplace Enabled must have a green light on the Slides tab. The slide box containing the fireplace must be fully extended to operate the fireplace.

## INTERIOR FEATURES

**NOTE:** If the fireplace is on and the slide containing the fireplace is retracted even for a second, the fireplace will deactivate, and Fireplace Enabled will cease to have a green light on the Slides tab. To return the functionality of the fireplace, fully extend the slide-out, and turn the fireplace back on.



Figure 12-5: Rear Fireplace

**NOTE:** The fireplace will not automatically turn back on if the slide is moved. Once Fireplace Enabled has a green light, the fireplace must be turned back on for operation.

## HEATED TILE FLOOR (OPTIONAL)

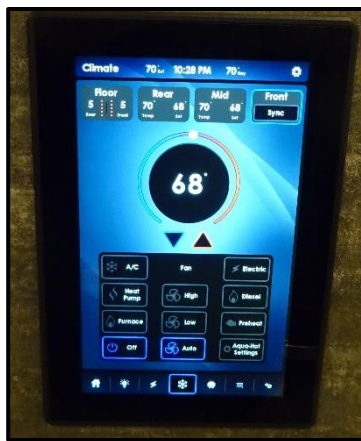

Figure 12-6: Optional Heated Tile Floor Controller

Your Allegro Bus might be equipped with an optional heated tile floor. The heated tile floor does not heat the air but gently warms the surrounding surfaces and occupants, allowing for a lower thermostat setting than traditional heating methods while providing the same comfort level.

Peak floor temperature is 25-30 degrees above ambient floor temperature.

The system uses a controller (Figure 12-6) that regulates the floor temperature by means of a sensor built into the floor, thus ensuring that the temperature sensed by the controller and the owner are the same. The optional heated tile floor provides clean, quiet heat, with

no blowers or transformers, and it creates no hum or noise. The thermostat makes a quiet clicking as it switches on.

For further operating instructions, refer to the manufacturer's literature in the Owner's Information Package.

## INTERIOR FEATURES



# CAUTION

If using the floor heat as a primary heat source in freezing temperatures, be sure to activate the Aqua-Hot heating system in the basement to prevent water lines from freezing.

## CEILING

The ceiling (Figure 12-7 and Figure 12-8) in the motorhome is covered with a padded-vinyl headliner, which can be easily cleaned with a damp, soft cloth, and a mild detergent.

Clean around all vent areas to prevent any build-up of dirt, grease, or other accumulations.



Figure 12-7: Contemporary Ceiling Treatment



Figure 12-8: Traditional Ceiling Treatment

## CEILING FAN

The ceiling fan (Figure 12-9) operates on 12V power and features a two-speed fan (low and high).

There is a switch on the fan itself to allow for the desired rotation, clockwise or counter clockwise.

To change rotation, be sure the main fan switch is in the OFF position.



Figure 12-9: Ceiling Fan



# INTERIOR FEATURES

## WINDOW TREATMENT

Throughout the Allegro Bus, the window treatments consist of two shades — solar and blackout (Figure 12-10).

The solar shade enables one to see out during the daytime, motorhome. The blackout shade creates complete privacy for nighttime.

The shades are located on all the windows in the living area and the bedroom, as well as in the cockpit.

The shades can be controlled by using the automatic control switch (Figure 12-11).



Figure 12-11: Day/Night Window Shade Control



Figure 12-10: Day/Night Window Shades

## MULTIPLEX LIGHTING CONTROL

The multiplex system (Figure 12-12) enables you to control circuits from multiple locations in the coach. Each switch enables you to turn a circuit ON or OFF with individual button presses, and provides an indicator light to determine the status of the circuit (ON or OFF). Many of the circuits are also dimmable by holding the button to dim.

Additional features of the multiplex system include the following:

- **Master Feature** (this is only on the control panel located at the entrance door) — Enables you to turn all lighting circuits ON or OFF by pressing a single button labeled Light Master. Pressing the Light Master OFF switch will turn off all the interior lights within the coach. Pressing the Light Master ON switch will turn on the same circuits that were on when the Light Master OFF switch was pressed. All Light Master OFF remembers that were on when the switch was pressed will turn back on when the Light Master ON switch is pressed again. Holding the Light Master ON switch will turn on all interior light circuits.
- **Switch Panel Backlighting** — All of the switches are backlit to make the labels easy to read. If you desire to turn the panel lights off, a switch is conveniently located at the center of the coach labeled



Figure 12-12: Load Center

## INTERIOR FEATURES

Panel Lights, which enables you to turn the back lighting ON, OFF, or DIM.

- **Status LED Indicator** — A green LED beside each switch indicates whether the load is on or off. In some cases, certain switches such as Awnings, Compartment Locks, and Generator do not have a status indicator at the switch.
- **Dimming Circuits** — Certain circuits within the coach are dimmable. To dim a light down, hold the OFF switch until the light is at the desired level, and release the switch. This setting will be remembered the next time the circuit is turned ON. To adjust the light up, hold the ON switch until the light is at the desired level, and release the switch.

## WALL SCONCE



The Allegro Bus comes with a decorative wall sconce (Figure 12-13), which provides an attractive lighting design to the interior of your motorhome.

Figure 12-13: Wall Sconce

# ALLEGRO BUS

## PLUMBING & BATH FEATURES

---

Chapter

13

## PLUMBING & BATH FEATURES

### FRESHWATER SYSTEM

#### TANK-LEVEL MONITOR

The tank-level monitor (Figure 13-1) enables checking the approximate levels in the fresh, gray, and black-water holding tanks using the level monitors.

The tank-level monitor is located on the 10" touch panel in the hallway.

To use this monitor, press the LEVEL TEST button, and read the fresh, gray, and black-water tank levels.

The “empty” indicator light will briefly come on when the button is pressed. If the tank is full, all of the lights will be ON. Lights are sequentially arranged to indicate fluid levels in approximately third-tank increments. For example, if the tank selected is approximately two-thirds full, then the indicator lights “E” (for “empty”), “1/3”, and “2/3” will be lit.



Figure 13-1: Tank-Level Monitor

**NOTE:** The battery voltage display for the chassis and house battery banks are available on the same screen.

#### KITCHEN SINK



Figure 13-2: Kitchen Sink

The kitchen sink (Figure 13-2) is a built-in double sink with flip-out drawer at the front. A large galley window (Figure 13-3) is provided above the sink to allow for additional natural lighting in the kitchen area.

Wash the sink only with mild detergents and water and use a soft cloth for subsequent drying and polishing.



Figure 13-3: Galley Window

## PLUMBING & BATH FEATURES

### BATHROOM SINK, SHOWER, & ACCESSORIES

The motorhome is equipped with a shower and sink (Figure 13-5 and Figure 13-4). The shower uses a wall-mounted shower system. The bathroom sink area features a glass undermount sink with deck mounted faucets, and adjustable vanity shelves.

Use fiberglass cleaning or mild cleaning supplies to avoid scratching the surfaces.

ShowerMiser Water Saving recirculator is a part of the new shower system. It simply connects to your shower outlet. By flipping a small lever, you are able to redirect the cold water from the shower that would normally go down the drain, back into the fresh water tank. With its unique and patented color-change ability, will notify you in under 4 seconds (at normal room temperatures) that hot water has arrived. Once the hot water is present, just flip the lever back to the showerhead and you have hot water ready to go. (Blue button above the single handle faucet)

### NOTICE

**Do not use the Showermiser when connected to city water. This will cause the fresh water tank to overflow.**



Figure 13-4: Shower



Figure 13-5: Bathroom Sink

### WATER PUMP

The water pump is self-priming and totally automatic, operating on demand whenever water is required. The water pump is used to pressurize the freshwater system when the unit is not connected to city water. The switches (Figure 13-7) are located in various conveniently located areas throughout the motorhome where water is accessible, or on the Spider Controls System (Figure 13-6).



Figure 13-6: Spider Controls System Switch

## PLUMBING & BATH FEATURES

To start the pump:

1. Fill or partially fill the fresh water supply tank.
2. Open the kitchen and bathroom faucets.
3. Turn the water pump switch to ON and allow the water to fill to the water line and the hot water heater.
4. Close each faucet after it delivers a steady stream of water (close the cold-water faucet first). Leave the hot water faucets ON until they also deliver a steady stream of water. This procedure will ensure that the water heater is filled with water.



Figure 13-7: Water Pump Switch

The water pump will stop running once all faucets are closed. The water pump is now ready for automatic operation. The pump will run when a faucet is open and stop when a faucet is closed.

### NOTICE

**Never allow the pump to run for long period of time without water being present in the supply tank, as doing so might cause physical damage or blow fuses.**

If water does not flow when a faucet is turned ON while using the demand system, use the following troubleshooting chart:

SITUATION	SOLUTION
Pump running – no water	<ul style="list-style-type: none"> <li>Fill Tank</li> <li>Clear the water line to the pump</li> </ul>
Pump does not run	<ul style="list-style-type: none"> <li>Check the pump switch</li> <li>Check the 12 volt fuses</li> <li>Check the electrical connections</li> <li>Check the battery</li> </ul>

All the water must be drained from the freshwater system when the unit is not in use for extended periods. For more detailed information regarding the water pump, refer to the water pump manufacturer’s brochure in your motorhome Owner’s Information Package.



## PLUMBING & BATH FEATURES

### CITY WATER CONNECTION



Figure 13-8:  
Motorhome  
Water Hose

When connecting your unit to city water, use the water hose (Figure 13-8) manufactured and labeled for potable water service—this will ensure that the hose selected for use will not alter the taste of the water.

To connect the city water supply (Figure 13-9), connect one end of the hose to the city water supply.

Turn the city water supply ON for a few seconds to clear the line. Once the hose has been flushed, turn the supply OFF. Connect the other end of the hose to the city-water connections on the motorhome.

Once the city water fill valve is opened, water is supplied to the freshwater system including the hot water heater, faucets, and toilet. Turn ON the water supply and open all of the faucets to clear any trapped air within the plumbing lines within the motorhome.



Figure 13-9: City Water  
Supply Connection

Once any air pockets have purged from the water lines and water flows freely, close all of the faucets. The city water supply is pressurized; therefore, the water pump is not needed when the water system of the vehicle is connected to the city water system.

---

**NOTE:** If city water pressure is more than 60 psi, Tiffin Motor Homes recommends to use a water pressure regulator to prevent damage to the motorhome.

---

### FILLING THE FRESHWATER TANK

The freshwater tank is normally filled from the city water connection. The yellow handle city water/tank fill valve determines whether the city water is going through the water system or into the freshwater tank. Since there is no automatic shut-off when filling the freshwater tank, check the level from the monitor panel while filling the freshwater tank on the motorhome.

The excess water will be vented from an overflow in the vent pipe onto the ground when the capacity of that tank has been reached. This pipe is installed in the freshwater tank to prevent possible tank rupture from inadvertent overfilling.

All of the water must be drained from the freshwater system when the motorhome is not in use for an extended period.



## PLUMBING & BATH FEATURES

### WATER FILTER

This unit is equipped with a water filter (Figure 13-10), which must be removed before disinfecting the fresh-water system.



Figure 13-10:  
Water Filter

First, remove the water filter and then replace cover to allow the sanitizing solution access to the faucets. As installed, the filter will remove chlorine, dirt, and other matter. The filter will also eliminate most phenol (or similar) odors and tastes while delivering sparkling, taste-free water for drinking and cooking.

The water filter is located in the sanitation compartment on the outside of the motorhome. The water filter is not guaranteed to remove the tastes and odors of iron and sulfur. To remove these impurities, you need to chlorinate the water. Replacement filters are available that will filter iron and sulfur. Ask your dealer or RV supply center about purchasing an iron and sulfur filter.

If you are traveling in an area where the water has high iron and sulfur content, add one tablespoon of chlorine bleach to every 10 gallons of water in your tank—this will precipitate the iron or sulfur so that the filter can remove those impurities.

If you are at a site where the unit is connected to a city water supply, you will not be able to chlorinate the system because the water flows straight to your faucets and not through the freshwater tank.

Filters must be changed every 6-12 months depending on the quality and quantity of water that is used in your motorhome.

### FRESHWATER LINES

Check all of the plumbing connections for leaks at least on an annual basis.

If the water pump runs when all faucets are turned OFF, check for a possible leak. Be sure that the drain valves are closed. Connections at the kitchen and bathroom faucets normally seal by hand-tightening them and then making an additional half-turn with a wrench.

If a fitting leak persists, disconnect it completely and visually inspect it for mineral deposits or foreign material stuck on the sealing surfaces. Clean the surfaces thoroughly and reinstall the fitting. Take the motorhome to an authorized Tiffin Motor Homes service center for additional repairs if the water system continues to leak.

Follow the winterizing instructions given in Chapter 16 to reduce risk of leaks caused by cracks from freezing pipes. Left unchecked, freezing damage can be extensive and expensive.

## PLUMBING & BATH FEATURES

### SANITIZING

To ensure complete disinfecting of the freshwater system, Tiffin Motor Homes recommends that the following procedures be performed on a new system, on one that has not been used for a length of time, or one that might have become contaminated. This procedure is also recommended before long periods of storage, such as during the winter months:

1. Drain the freshwater tank by opening the drain valve. All of the faucets should be in the closed or OFF position.
2. Prepare a chlorine solution using one gallon of water and one-half cup of chlorine bleach (5% sodium-hypochlorite solution). Prepare enough of the chlorine solution to administer one gallon of solution for every 15 gallons of tank capacity. For sanitizing this unit, prepare 4½ gallons of the chlorine solution. This mixture puts a 50 ppm (parts per million) residual chlorine concentration in the water system that will act as a quick-kill dosage for harmful bacteria, viruses, and slime-forming organisms. Concentrations greater than 50 ppm might damage the water lines and/or the tank.
3. Once the freshwater tank is empty, close the drain valves in the water tank.
4. Pump the chlorine solution into the tank by taking the hose attachment and attaching it to the pump and then put in the chlorine solution. Close the valve from the fresh water tank to the pump and open the valve from the solution to the pump. Turn the tank fill valve from “city water” to “tank fill.” Turn ON the water pump until all of the solution is pumped into the fresh water tank.
5. Turn OFF the water pump. Open the valve from the tank to the water pump. Fill the water tank with the city water tank fill (or by using the same method as was used to put the sanitizing solution into the tank). Remove the water filter (from the drink dispenser faucet, if installed). Open each faucet, in turn, including the kitchen faucet, bath faucet, and inside and outside showers, turning ON both the hot and cold faucets and flushing the toilet until all of the air has been purged from the pipes and the water runs freely. The entire system will then be filled with the sanitizing solution.
6. Allow the 50-ppm disinfecting solution to stand in the system for at least four hours.
7. Drain the system and flush it with freshwater. The water system needs to be flushed with water repeatedly, if necessary, until there is no chlorine taste or smell left in the system. To remove any excessive chlorine taste or odor that might remain, prepare a solution of one quart of vinegar to five gallons of water. “Rock” the tank containing the solution by moving the vehicle forward and backward several times to clean the tank; then, drain that tank and refill with clean water.

## PLUMBING & BATH FEATURES

### WASTEWATER SYSTEM

#### WASTEWATER GENERAL INFORMATION

The waste drainage system was designed to provide adequate and safe storage and/or disposal of waste materials. All of the materials used in the fabrication of this system are tested by a nationally recognized testing laboratory. The drainage system uses plastic piping and fittings connected to the sinks, toilet, and holding tanks.

This plumbing permits the drainage of these fixtures to an outside termination. The vehicle should be reasonably level for best operation of both of the wastewater systems.

There are two, separate wastewater systems. The gray-water system is for wastewater from the sinks and shower. The black-water system is for sewage waste from the toilet. Each wastewater tank has its own control valve and both drain through a common sewer-drain hose.

Your Bus may have an optional Waste Water Elimination system. Please refer to the manufacture owner's manual for proper operation.



#### TOILET

All units are furnished with a mid-toilet (Figure 13-11) and some units are furnished with a mid-toilet and rear macerator toilet (Figure 13-12). Both toilets operate with water from either the fresh water tank with the water pump ON or the city water supply. Before using the mid-toilet or the macerator toilet, add water to the bottom of the tank. Refer to owner manuals for operating instructions, and refer to "Black-Water Holding Tank" instructions.



Figure 13-11:  
Mid-Toilet



Figure 13-12: Rear  
Macerator Toilet

- When using your mid-toilet, fill the toilet  $\frac{3}{4}$  full of water. To add water to the toilet bowl, lift the flush handle to fill the bowl until the desired water level is reached. To flush the toilet, push the handle down, then release it.

## PLUMBING & BATH FEATURES

### NOTICE

**It is important that you use as much water as possible when flushing to prevent tissue and other solids from clogging the holding tank outlet.**

- When using your rear macerator toilet (if your coach is furnished with one) press the ADD WATER switch to fill the bowl to the desired water level. To flush the toilet, press the FLUSH switch, and then release it.
- The toilet must be cleaned regularly for maximum sanitation and operational efficiency. Clean the toilet bowl with a mild bathroom cleaner.

### NOTICE

**Do not use chlorine or caustic chemicals, such as bleach or drain opening chemicals in your motorhome's toilet. This will damage the seals in the toilet and dump valves.**

## BLACK-WATER HOLDING TANK

The “black-water” (i.e., sewage) holding tank is located directly beneath a non-macerator toilet. Before using the toilet, you will need to treat the tank with water that is mixed with an odor-controlling chemical. These chemicals are readily available at any RV supply store. Pull the toilet levers forward to allow the chemicals to mix with the toilet water. Continue pulling the toilet levers until a depth of at least one inch of solution is directly under the toilet. Release the levers. The waste tank is now ready for use.

## GRAY-WATER HOLDING TANK

The gray-water holding tank is located in the underbelly of the vehicle. It is primarily used for the drainage from the kitchen and bath sinks, and the shower.

## PLUMBING & BATH FEATURES

### P-TRAPS

Each of the sink drains and the shower drain has a water trap (P-trap) to prevent holding-tank odors from entering the vehicle.

These traps must have water in them to trap odors. When the vehicle is in motion, the water might splash out of the sink and shower drains. When the vehicle is stored, the water might evaporate from these traps allowing odors to enter the vehicle. If this occurs, run water from the faucet into the drain, allowing water to fill the traps again.

### NOTICE

**Use only RV odor-controlling chemicals in the holding tanks. Products containing ammonia and petroleum will damage the ABS plastic holding tanks and seals.**

### WASTEWATER DISPOSAL

Both of the holding tanks terminate in a valve arrangement that permits draining each tank separately or together.

Drain the black-water tank first before draining the gray-water tank. This procedure permits the water from the gray tank to wash the black-water residue from the drain lines and hose found in the external sanitation compartment.

---

**NOTE:** The T-handles (Figure 13-13) are color coded to distinguish between the black-water holding tank and the gray-water holding tank. The black-water holding tank T-handle is black and the gray-water holding tank T-handle is gray.

---



Figure 13-13: Sanitation Coupling

The valves that open to release the water are called gate valves. The blade that closed the opening in the sewer drainpipes is connected to the T-handle to release contents of the tanks when pulled. The sewer line must be securely capped during self-containment use to prevent leakage of waste materials. Do not pull the holding tank gate valve OPEN when the protective cap is installed on the pipe.

Always drain the tank into an acceptable sewer inlet or dump station. Whenever possible, drain both the holding tanks before traveling. The carrying capacity of your vehicle will be reduced if water is left in the black or gray tanks. The holding tanks must be drained only when they are at least  $\frac{3}{4}$  full. Doing this will

## PLUMBING & BATH FEATURES

provide a sufficient volume of water to allow the complete flushing of waste materials in the drain lines and hose. If the tanks are not  $\frac{3}{4}$  full, add enough water to allow for sufficient flushing.

Unscrew the cap from the drain. Connect the hose, with the adapter in place, to the drain fitting. Open the gate valve completely by pulling on the T-handle. The tank will start to drain as soon as the T-handle is pulled. After you have drained the black-water tank, immediately drain the gray-water tank. This procedure helps to flush the black-water from the sewage hose.

When both the tanks are empty, flush them with a freshwater rinse before you close the valves. The gray tanks are flushed by pouring a couple of gallons of water into a sink drain. The drain outlet is engineered for quick release of the drain hose adapter. Always close the gate valves and secure the end cap to prevent leakage while the vehicle is in transit.

After draining the black-water tank, add a holding-tank deodorant to help control the odor and break down the solids. Follow the instructions given on the holding-tank deodorant package.

## SEWER CONNECTION AND CAMPING

While using the motorhome, it is important to keep the black-water holding tank gate valve closed at all times, except when dumping. This allows an ample amount of liquid to remain in the tank to provide a smooth flow through the gate and the drain valves when dumping.

Sufficient liquid in the tank causes a swirling action that takes any accumulated solid wastes with it. Accumulation of solid wastes in the black-water tank can be avoided by keeping the gate valve closed when connected to the sewer connection. The gray tank can be kept open while hooked to a sewer connection.

---

**NOTE:** Dump the black-water tank first, then the gray-water tank.

---

## NO FUSS FLUSH



Figure 13-14: No Fuss Flush Connection

This vehicle is equipped with a flushing system for the black-water holding tank. When draining your sewer tank, attach a water hose to the tank flush connection. After the tank is drained, leave the gate valve “open” and open the water valve to allow the water to spray inside the black-water tank. This will clean the inside of the tank of any debris that might be left inside the tank. After this procedure is done, disconnect the freshwater hose and close the gate valve.

## NOTICE

**Be sure the gate valve is OPEN when flushing the tank. Do not use the same hose that is used for filling the fresh water tank for the No Fuss Flush.**



## PLUMBING & BATH FEATURES

### EXTERIOR SHOWER

Your motorhome has an exterior shower (Figure 13-15) for your use and convenience outside the motorhome.

The exterior shower is located in the service compartment on the driver's side and enables you to do such things as rinse off sand or grass, muddy shoes, or bathe yourself outside of your motorhome.

The faucet operates just as it would in your kitchen or bathroom.

There is also a soap dispenser and light conveniently located in the compartment.



Figure 13-15: Exterior Shower and Shower Light

### AQUA-HOT HEATING SYSTEM

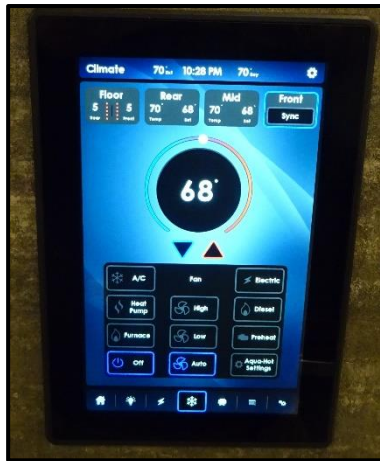

Figure 13-16: Aqua-Hot Heating System Control Screen

The Allegro Bus is equipped with an Aqua-Hot heating system (Figure 13-16) that provides a continuous, on-demand supply of domestic hot water, and interior zone heating where and when it is needed.

In the Allegro Bus, the controls for the Aqua-Hot heating system are integrated with the Spyder Controls System. To activate the Aqua-Hot heating system, select the Aqua-Hot option from the Spyder Controls System home screen. By activating this switch, a supply of hot water as well as interior heat can be provided.

The heating feature will be controlled by the thermostat mounted on the Spyder Controls System. It is operated off the furnace function of the thermostat to provide interior heat. Hot water will be supplied instantaneously and continuously at any time the diesel burner switch is activated.

If interior heat and hot water are demanded from the Aqua-Hot system at the same time, hot water will simultaneously take precedence over interior heat; therefore, causing the interior heat to shut down and turn off until the water flow is turned off from water sources.

Also featured in the Aqua-Hot system is an electrical burner switch (labeled Electric Water Heater). With this switch activated and shore power available, it will supply a very limited amount of hot water and limited interior heat.



## PLUMBING & BATH FEATURES

The surge tank (Figure 13-17) located in the basement must be routinely inspected to make sure the antifreeze fill line stays in the acceptable zone. If the antifreeze becomes low, you must add the recommended antifreeze stated in the Aqua-Hot owner's manual. If antifreeze is totally depleted from the surge tank, a switch will be released inside the main Hydro-Hot tank, disabling the system from operating. Antifreeze will then have to be added to the tank to reactivate the switch and allow the system to operate.

If batteries accidentally become discharged and the Aqua-Hot system is activated, the system will automatically shut down before batteries are totally discharged. Once power is restored to batteries, the system must be reset on the outside control board.



Figure 13-17: Aqua-Hot Surge Tank

### NOTICE

Your Aqua-Hot heating system operates off the motorhome's sole diesel tank. Keep in mind that the Aqua-Hot fuel tube is located higher up in the diesel tank than the motorhome's engine fuel in order to prevent complete depletion of the diesel fuel tank. **BE SURE AN ADEQUATE AMOUNT OF FUEL IS IN THE TANK BEFORE DRY CAMPING.**

### NOTICE

Yearly maintenance is required on the burner portion of the Aqua-Hot heating system.



### WARNING

**DO NOT** operate the diesel-burner and/or the electric heating element without the water and anti-freeze solution in the Aqua-Hot's boiler tank. Failure to do so will cause **SERIOUS DAMAGE** to the heater.

# PLUMBING & BATH FEATURES

## PLUMBING DIAGRAM

35CP

35CP Plumbing Layout

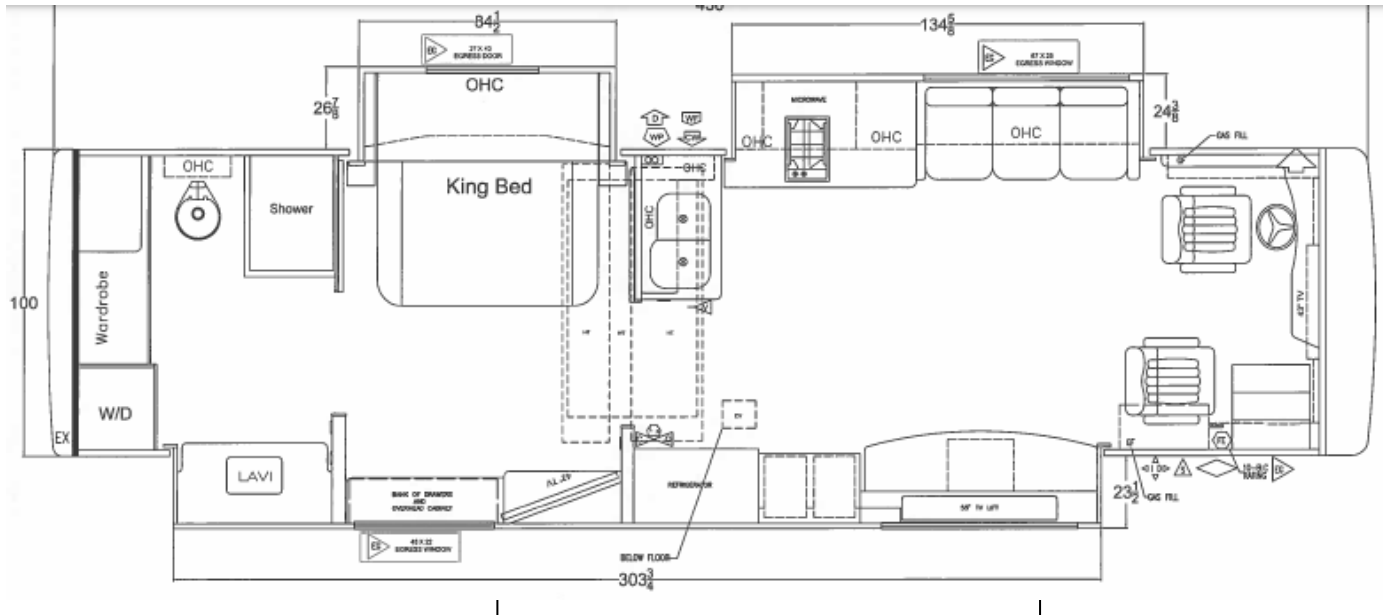

ITEM	QTY	PLUMBING	DESCRIPTION	UNIT	QTY	PLUMBING	DESCRIPTION	UNIT
1	1	PIPE	1/2\"/>					

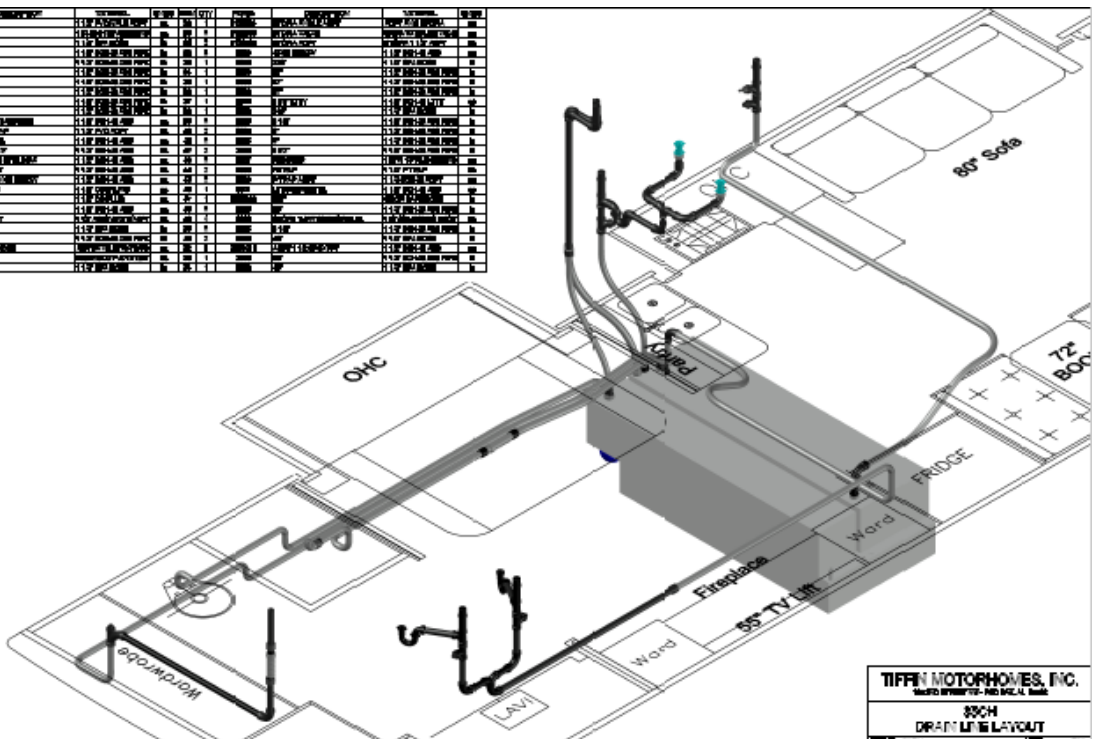

TIFFIN MOTORHOMES, INC.  
 830H  
 DRAIN LINES LAYOUT



# PLUMBING & BATH FEATURES

40IP

## 40IP Plumbing Layout

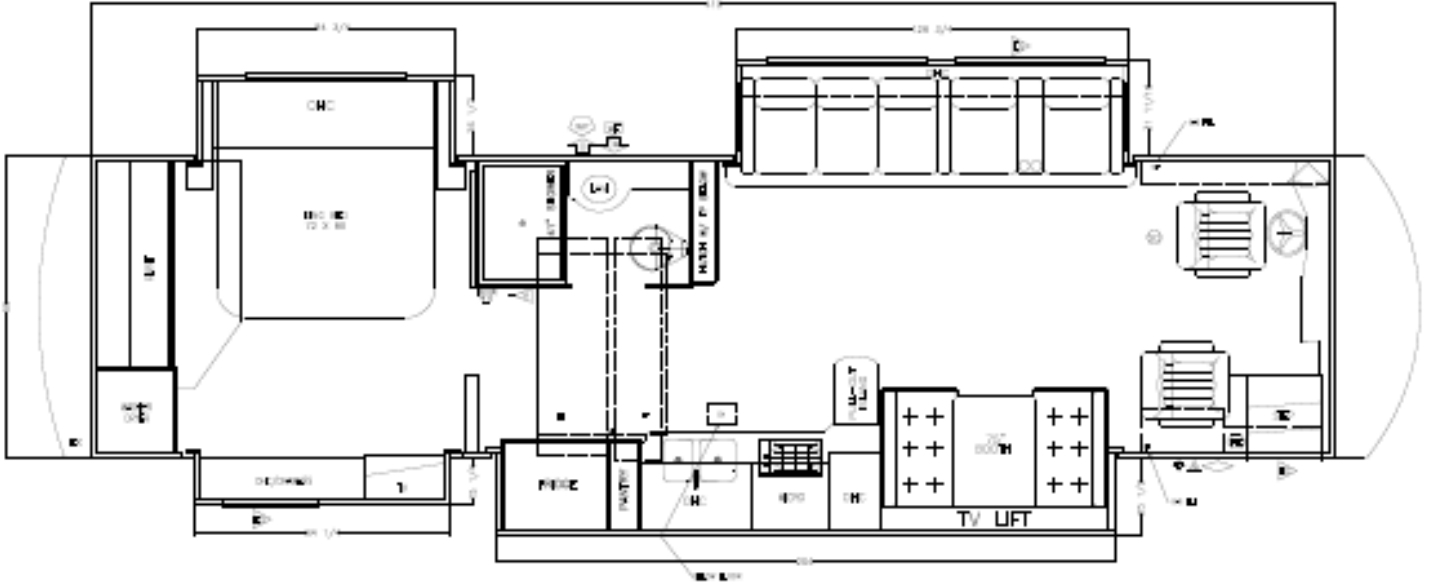

# PLUMBING & BATH FEATURES

## 40IP Water Line Layout and Drain Line

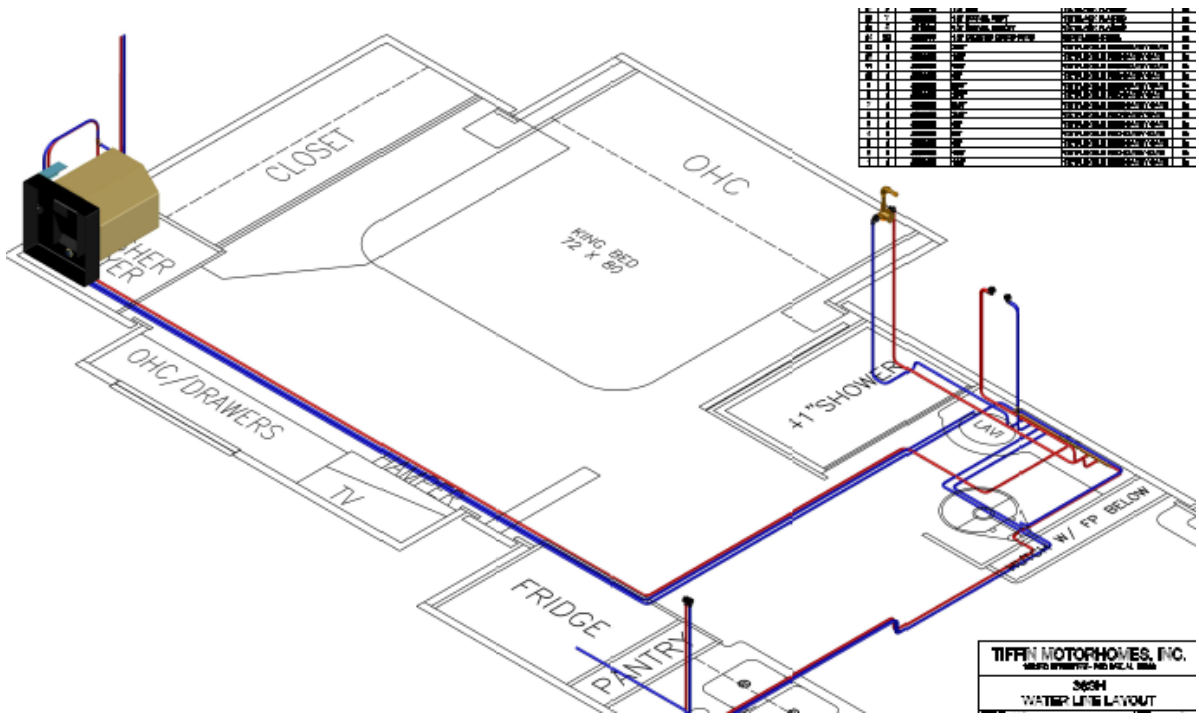

NO.	SYMBOL	DESCRIPTION	QUANTITY	UNIT
1	1/2\"/>	1/2\"/>	1	FT.
2	3/4\"/>	3/4\"/>	1	FT.
3	1\"/>	1\"/>	1	FT.
4	1 1/2\"/>	1 1/2\"/>	1	FT.
5	2\"/>	2\"/>	1	FT.
6	3\"/>	3\"/>	1	FT.
7	4\"/>	4\"/>	1	FT.
8	6\"/>	6\"/>	1	FT.
9	8\"/>	8\"/>	1	FT.
10	10\"/>	10\"/>	1	FT.
11	12\"/>	12\"/>	1	FT.
12	14\"/>	14\"/>	1	FT.
13	16\"/>	16\"/>	1	FT.
14	18\"/>	18\"/>	1	FT.
15	20\"/>	20\"/>	1	FT.
16	22\"/>	22\"/>	1	FT.
17	24\"/>	24\"/>	1	FT.
18	26\"/>	26\"/>	1	FT.
19	28\"/>	28\"/>	1	FT.
20	30\"/>	30\"/>	1	FT.
21	32\"/>	32\"/>	1	FT.
22	34\"/>	34\"/>	1	FT.
23	36\"/>	36\"/>	1	FT.
24	38\"/>	38\"/>	1	FT.
25	40\"/>	40\"/>	1	FT.
26	42\"/>	42\"/>	1	FT.
27	44\"/>	44\"/>	1	FT.
28	46\"/>	46\"/>	1	FT.
29	48\"/>	48\"/>	1	FT.
30	50\"/>	50\"/>	1	FT.
31	52\"/>	52\"/>	1	FT.
32	54\"/>	54\"/>	1	FT.
33	56\"/>	56\"/>	1	FT.
34	58\"/>	58\"/>	1	FT.
35	60\"/>	60\"/>	1	FT.
36	62\"/>	62\"/>	1	FT.
37	64\"/>	64\"/>	1	FT.
38	66\"/>	66\"/>	1	FT.
39	68\"/>	68\"/>	1	FT.
40	70\"/>	70\"/>	1	FT.
41	72\"/>	72\"/>	1	FT.
42	74\"/>	74\"/>	1	FT.
43	76\"/>	76\"/>	1	FT.
44	78\"/>	78\"/>	1	FT.
45	80\"/>	80\"/>	1	FT.
46	82\"/>	82\"/>	1	FT.
47	84\"/>	84\"/>	1	FT.
48	86\"/>	86\"/>	1	FT.
49	88\"/>	88\"/>	1	FT.
50	90\"/>	90\"/>	1	FT.
51	92\"/>	92\"/>	1	FT.
52	94\"/>	94\"/>	1	FT.
53	96\"/>	96\"/>	1	FT.
54	98\"/>	98\"/>	1	FT.
55	100\"/>	100\"/>	1	FT.

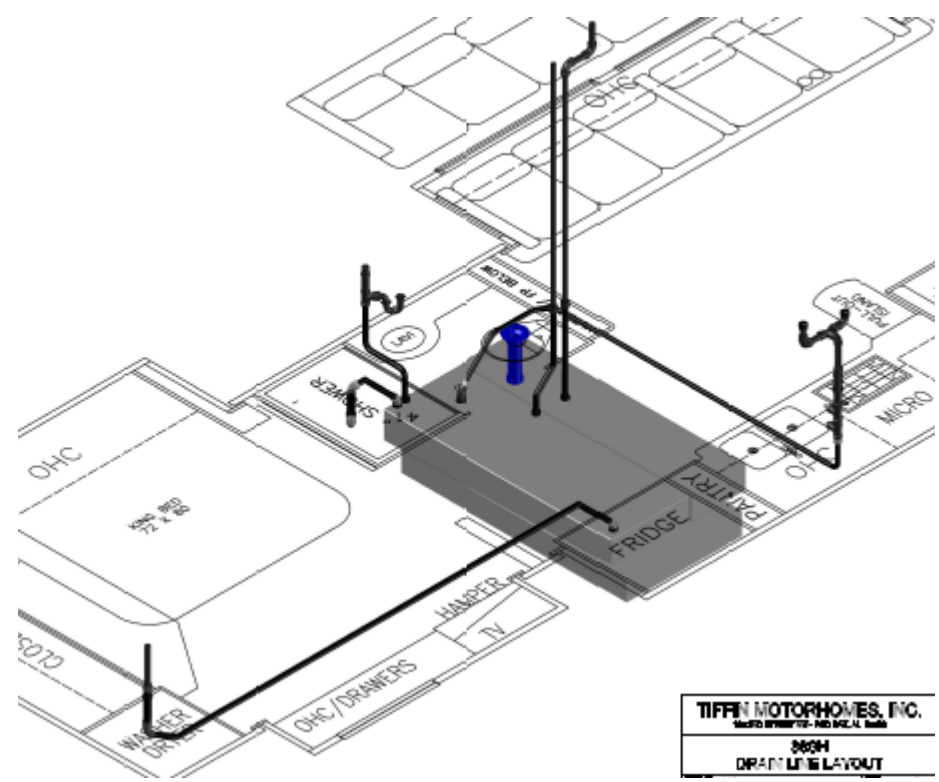

# PLUMBING & BATH FEATURES

45FP

45FP Water Line Layout  
and Drain Line Layout

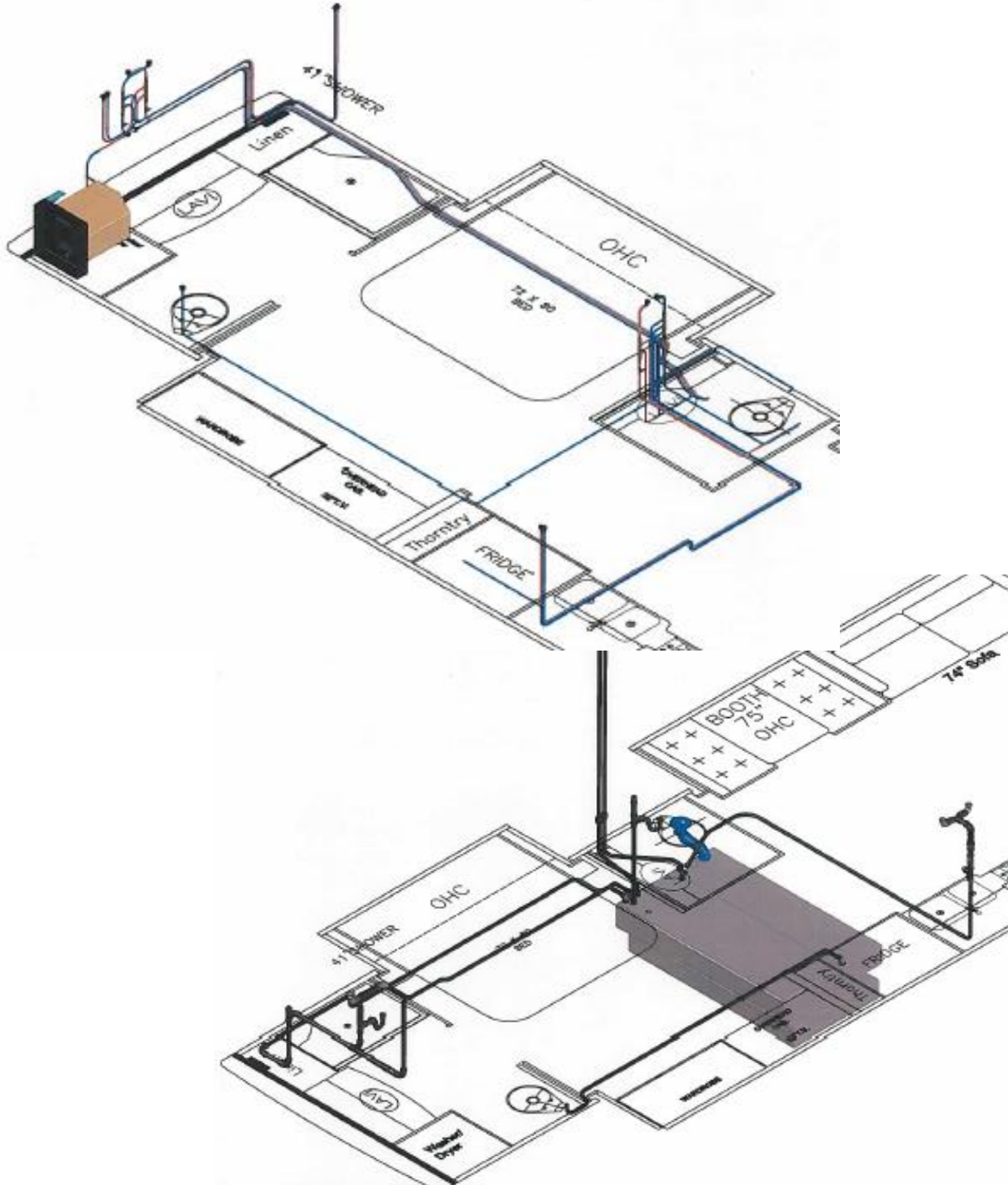



# PLUMBING & BATH FEATURES

45OPP

## 45OPP Plumbing Floor Plan and Waterline Layout

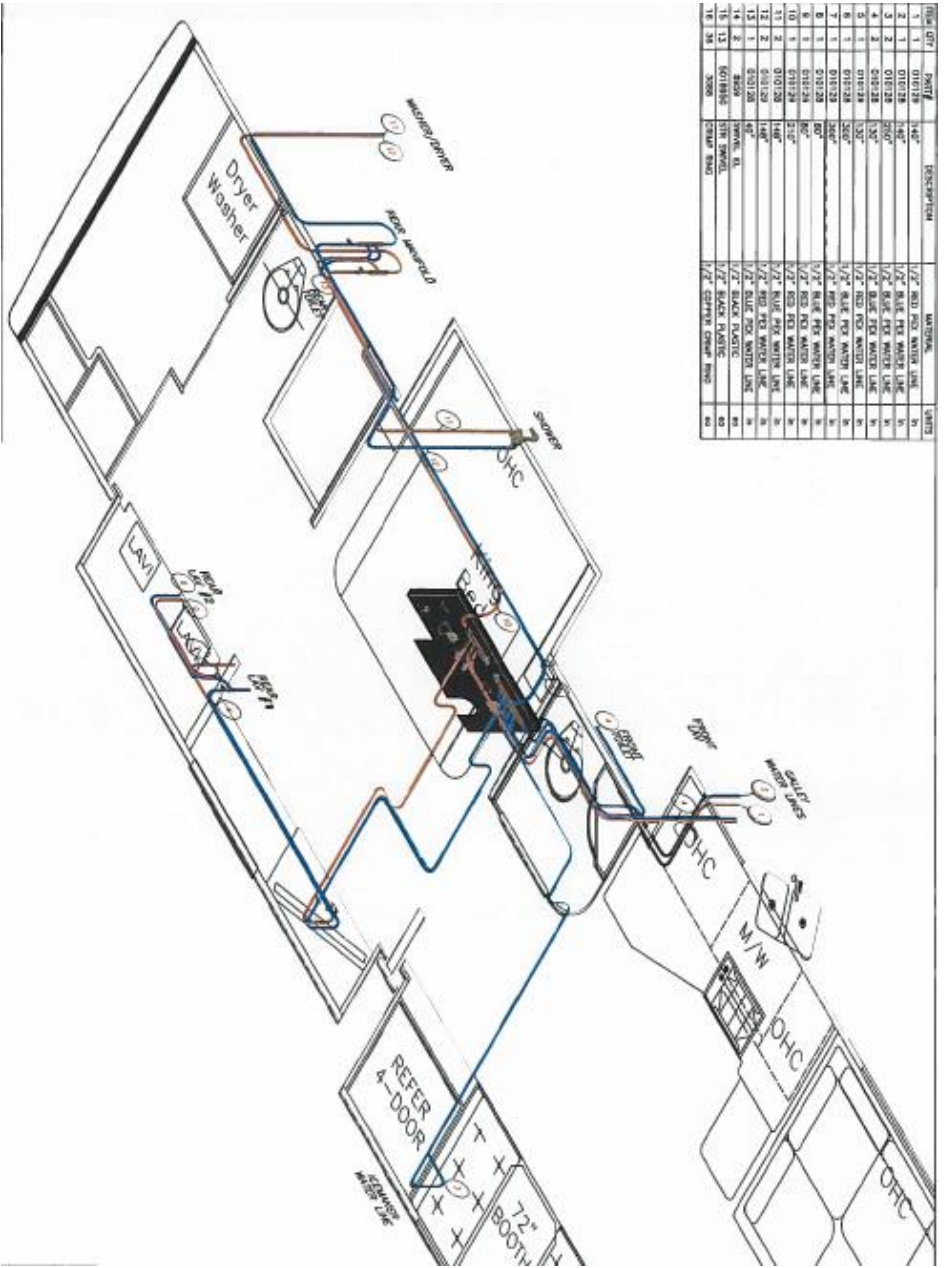
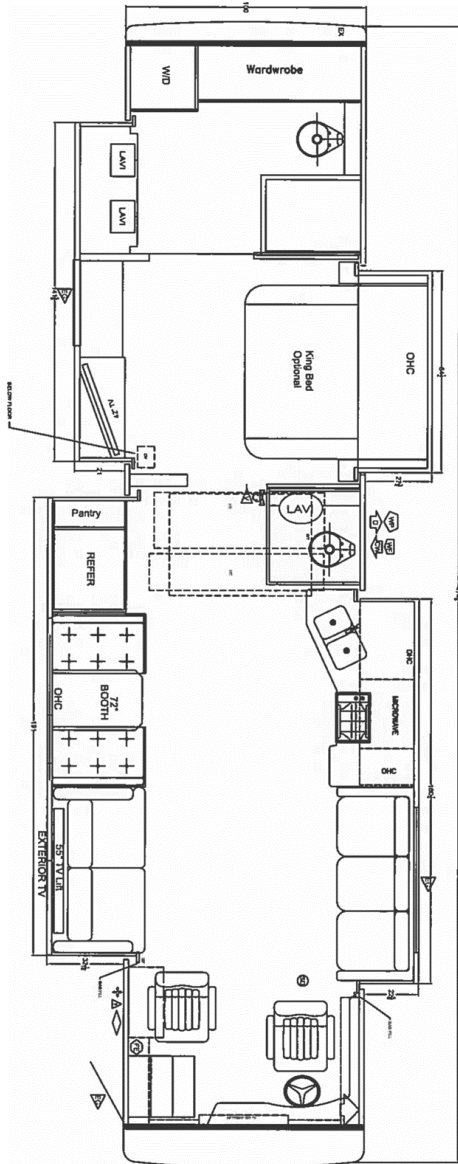

ITEM QTY	UNIT	DESCRIPTION	MATERIAL	QTY
1	1	1/2" HDG PIP WATER LINE	1/2" HDG PIP WATER LINE	1
2	1	1/2" HDG PIP WATER LINE	1/2" HDG PIP WATER LINE	1
3	2	1/2" HDG PIP WATER LINE	1/2" HDG PIP WATER LINE	2
4	2	1/2" HDG PIP WATER LINE	1/2" HDG PIP WATER LINE	2
5	1	1/2" HDG PIP WATER LINE	1/2" HDG PIP WATER LINE	1
6	1	1/2" HDG PIP WATER LINE	1/2" HDG PIP WATER LINE	1
7	1	1/2" HDG PIP WATER LINE	1/2" HDG PIP WATER LINE	1
8	1	1/2" HDG PIP WATER LINE	1/2" HDG PIP WATER LINE	1
9	1	1/2" HDG PIP WATER LINE	1/2" HDG PIP WATER LINE	1
10	1	1/2" HDG PIP WATER LINE	1/2" HDG PIP WATER LINE	1
11	2	1/2" HDG PIP WATER LINE	1/2" HDG PIP WATER LINE	2
12	1	1/2" HDG PIP WATER LINE	1/2" HDG PIP WATER LINE	1
13	1	1/2" HDG PIP WATER LINE	1/2" HDG PIP WATER LINE	1
14	2	1/2" HDG PIP WATER LINE	1/2" HDG PIP WATER LINE	2
15	13	1/2" HDG PIP WATER LINE	1/2" HDG PIP WATER LINE	13
16	30	1/2" HDG PIP WATER LINE	1/2" HDG PIP WATER LINE	30



# PLUMBING & BATH FEATURES

45OPP

45OPP Aqua Hot Layout and Drain Line Layout

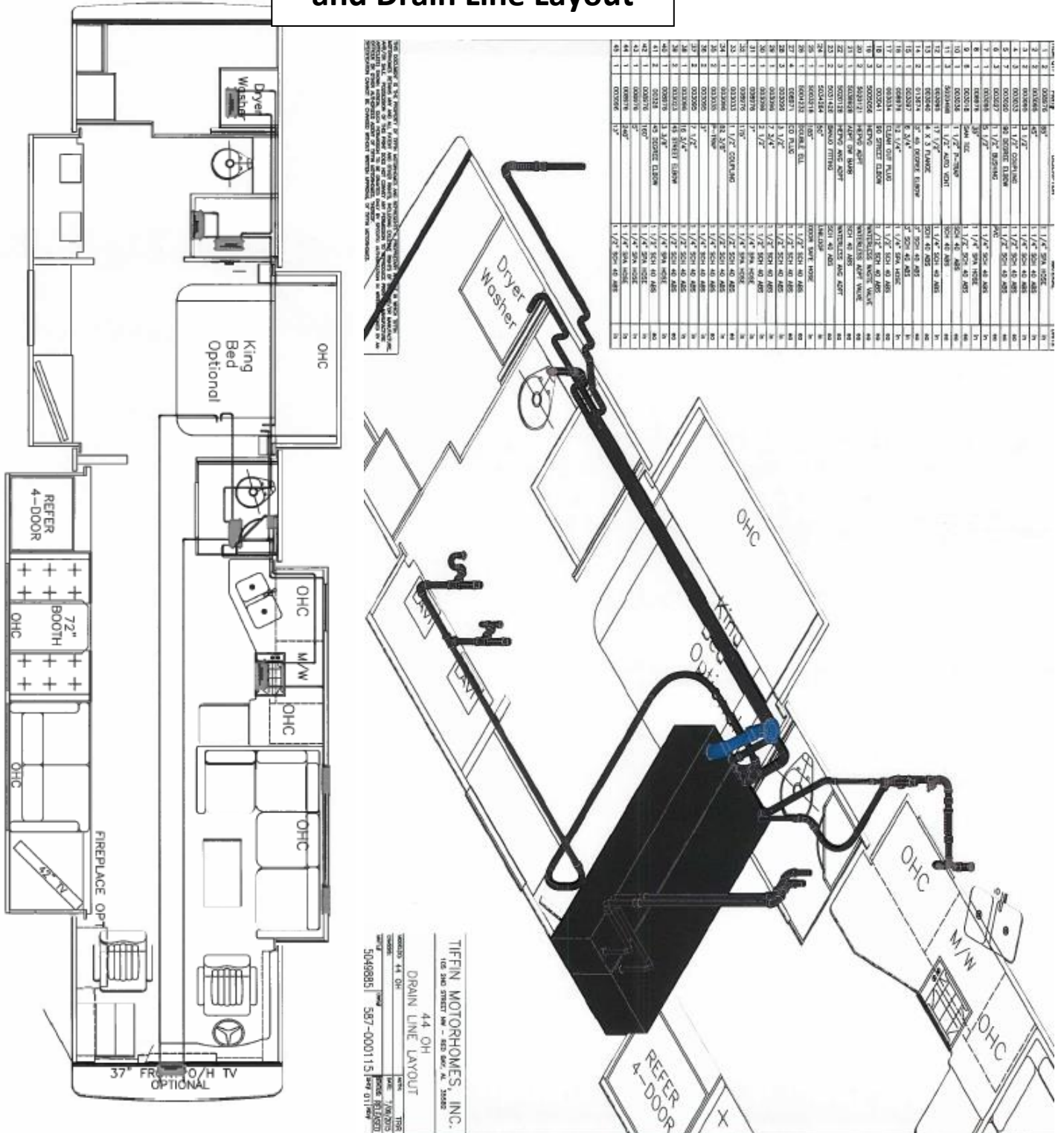

# ALLEGRO BUS

## WINDOWS, AWNINGS, VENTS, & DOORS

---

Chapter

14

## WINDOWS, AWNINGS, VENTS & DOORS

### WINDOWS

Sliding windows (Figure 14-1) are custom built for the motorhome and allow easy sliding access to open the coach to fresh outside air.

There might also be a reflective coating on the windows to reflect back a portion of the sunlight to reduce the heating of the motorhome interior and to reduce the effects of the sun's "bleaching" of interior fabrics (curtains, upholstery).

Sunshades on both the driver and passenger's sides can be deployed and moved at any time.

Windows throughout the coach are designated as "EXIT" windows in the event of an emergency.

To help make the windows slide more easily, we recommend using Plexus Plastic Cleaner, which can be purchased through the Tiffin Motor Homes Service Department.



Figure 14-1: Motorhome Windows

### AWNINGS



Figure 14-2: Awnings

The unit is equipped with Girard awnings (Figure 14-2). The awnings run on 120 VAC. The awning control switch is located in the front overhead cabinet above the driver's seat. This switch can be removed from the overhead, and used as a remote control to operate the awnings.

The awning control switch is designed to allow the user to control each awning (if optioned) individually. All function buttons are press ON. The auto-functions continue until the awning is extended or retracted to the desired position. It is not necessary to hold the button while the function is active.

#### **In case of awning power failure or to manually close the awning:**

- The Girard GG750 has a manual override to close the awning in case of power failures.
- Remove the endcap opposite the motor, by removing the 3 Philips head screws.

## WINDOWS, AWNINGS, VENTS & DOORS

- Using a 13mm wrench, turn the square manual override shaft in order to close the awning, see Figure below.  
NOTE: The manual override is one-way, it can only be used to close the awning.
- Replace endcap using the 3 Philips head screws.
- Figure below is showing a right hand motor version of the GG750. If your coach is equipped with a left hand version, the manual override will be on the opposite side.
- Once power is restored, the awning will resume normal operation.

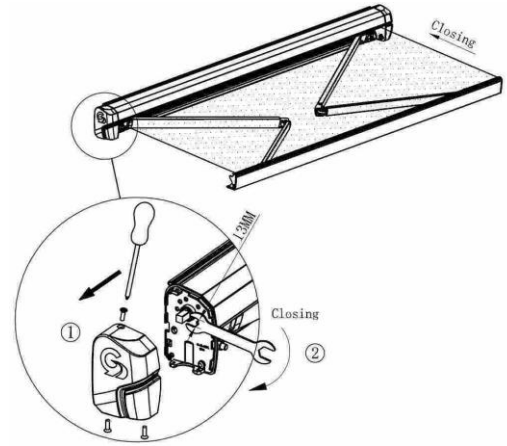

**NOTE:** This procedure can also be used to manually retract the Over the Door Awning.

### AWNING REMOTE CONTROL

A removable remote control switch is provided with the awning system (Figure 14-3). The remote functions in the same manner as the stationary control panel. The remote enables you to operate the awning from any convenient location.

There are arrows located on the bottom left and right corners of the awning control switch. These arrows allow you to select front or rear awning.

---

**NOTE:** The numbers range from 0 to 5, but 1 (front) and 2 (rear) are used for the awnings.

---

Once the awning has been selected for operation, the light button activates the light on the awning. The arrows facing up and down on the right-hand side of the switch allow the awning to extend and retract. The button in the center (that is a line) on the right side of the switch allows the user to stop the awning at a desired location instead of fully extending or retracting. Refer to your Girard dealer for more in-depth awning questions.

---

**NOTE:** The awnings may also be controlled from the awning control boxes located in the front cargo bay on the passenger side of the unit. To operate the awnings using the white control box, touch the arrows on the side of the control module to extend and retract the desired awning. There are two white control modules.

---



Figure 14-3: Awning Remote Control

## WINDOWS, AWNINGS, VENTS & DOORS



Figure 14-4: Awning Remote  
(located in the front cargo bay)

### VENTS

The kitchen and bathroom are both equipped with a 12 VDC exhaust vent (Figure 14-5). The fans are controlled by the fan tab on the Spyder Controls System (Figure 14-6). A three-speed switch on each vent fan controls the fan speed.



Figure 14-5: Overhead Vent Fan



## WARNING

Since damage resulting from weather is not under warranty, anytime a heavy or prolonged rain or blustery winds are anticipated, close the awning. Similarly, if the awning is to be left unattended for any prolonged length of time, close the awning.



Figure 14-6: Vent/Fan Controls

---

**IMPORTANT:** The vent fan must be left in the ON mode only when the motorhome is parked and in use. The fan will not operate until the vent is open.

---

### DOORS

The primary entrance door to the motorhome has a key lock and a dead bolt for additional security. When the door is fully opened, the door hinge automatically holds the door in an OPEN position.

In addition, a screen door allows increased air circulation when the entrance door is open.



## WINDOWS, AWNINGS, VENTS & DOORS

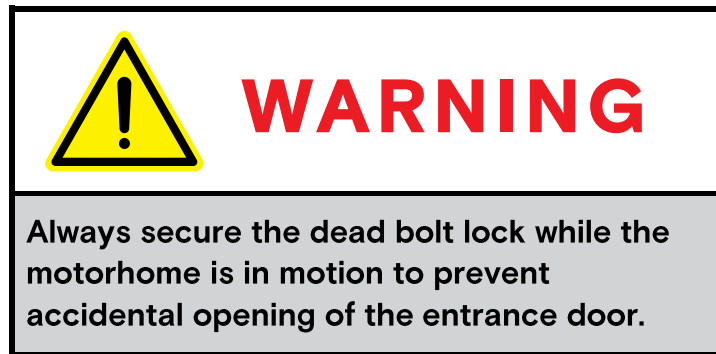

### KEYLESS LOCK

The Allegro Bus is equipped with keyless lock entry that is incorporated into the grab handle (Figure 14-7). The keyless lock entry is essentially a numeric combination lock.

This type of lock for the motorhome enables the owner to come and go without having to worry about whether the “house key” was with the owner or not. The keyless lock drastically reduces the inadvertent situation of being “locked out of one’s home” while on the road.

Also included with the keyless entry is a key fob that will lock and unlock the entrance door as well as compartment doors. The headlights and clearance lights will flash, indicating that the doors are locked when pressing the lock button on the key fob. When pressing “unlock,” the porch lights will be activated for 30 seconds.

As long as you remember the appropriate combination (settable by the owner to permit optimal remembering of a preferred numerical combination), you should never be “locked out” of the motorhome under any circumstances.

Complete directions for setting your unique keyless lock combination can be found in the Owner’s Information Package.

As a further aid for nighttime access to the motorhome, the handrail by the front door is made of transparent acrylic, which is lighted at night. This “night light” handrail permits the motorhome owner easy and safe access to the motorhome by providing a firm, easily seen handhold whenever entering or exiting.



Figure 14-7: Allegro Bus Keyless Lock and Handle



# ALLEGRO BUS

## DRIVING YOUR MOTORHOME

---

Chapter

15

## DRIVING

### INSTRUMENT PANEL

The instrument panel on your Allegro Bus serves as a multi-function device. Not only does it provide information regarding fuel level and RPM, it provides tire pressure, levelling function and Mobile Eye information (Optional) and the ATC light.

Please refer to your chassis operator's manual for details regarding the operation of these items.



### ECOMASTER CAMERA MONITOR SYSTEM



Figure 15-1: Rear-View Camera Monitor System

The rear-view monitoring system (Figure 15-1) is provided to aid the driver in backing and parking the motorhome.

A camera mounted on the rear of the vehicle feeds a televised view of the rear of the motorhome to the monitor located in the front near the driver.

If the switch is in the MANUAL mode, the monitor will be ON when the ignition switch is turned ON.

If the switch is in the AUTOMATIC mode, the monitor will display the picture from the rear-mounted camera only when the transmission is in REVERSE gear.

To use this system effectively, refer to the owner's manual for this system. This manual is in the Owner's Information Package.

### BASIC REAR VIEW CAMERA OPERATION

1. Depress the POWER switch. The picture appears on the monitor. POWER indicator lights up green. To turn off the picture, press it again to release. The monitor moves to standby condition. POWER indicator lights up red.
2. Adjust the VOLUME control.
3. Adjust the picture contrast and brightness. The DAY/NIGHT selector switch must normally be kept in the DAY (released) position. When you view the picture at night or in a tunnel, etc., depress the switch to make the picture less bright (therefore in the NIGHT position). Thus, the picture will be easy to view even in a dark place.

## DRIVING

When you set the gear level to the “R” position with the POWER switch released, the monitor is turned ON, and the picture from the camera connected to the CAMERA “A” connector appears irrespective of the INPUT knob setting.

### SIDE-MOUNT CAMERA

As an enhanced aid to driving, the motorhome features side-mounted cameras (Figure 15-2) on both sides of the motorhome.

These side-mounted cameras are activated whenever the motorhome in transit begins to make a turn. When the LEFT turn indicator is used, the left-side camera is activated and that camera displays on the back-up monitor a rearward-oriented view of the driver’s side showing that side of the motorhome and a limited panorama of what is alongside and immediately behind the motorhome as it begins to turn into that direction.

In this manner, the typical “blind spot” of most motorhomes is drastically reduced or eliminated so that the driver can make those turns with great confidence. Similarly, the “right” turn indicator operates in the same manner to show a rearward view of the right side of the motorhome when a right-hand turn is made.



Figure 15-2: Side-Mount Camera Monitor

### CB RADIO SYSTEM ANTENNA CONNECTION

As an option, the motorhome might come equipped with an antenna and coaxial cable connection to enable the owner to install a Citizens Band (CB) radio of choice, and operate it conveniently from the motorhome.

The coaxial-cable connection for the radio is found beneath the dashboard on the driver’s side. Accordingly, with an owner-provided CB radio, that radio can be used to communicate with other travelers on the road.

To use your CB system of choice, follow the directions furnished with the CB radio.

---

**NOTE:** Channel 11 is considered an emergency channel and monitoring this channel might give one information about road conditions, accidents, and related matters potentially affecting your travels.

---

## DRIVING

### AM/FM/CD STEREO SYSTEM

An AM/FM/CD stereo system (Figure 15-3) is included in the motorhome.

This system is powered by the 12-volt DC system of the motorhome and operates like any conventional car-stereo system. The coach is also SIRIUS XM compatible with a subscription.



Figure 15-3: CD Player

### DASHBOARD HEATING/COOLING CONTROLS

The dash air conditioner/heater (Figure 15-4) is not designed to heat and cool the entire interior of the motorhome. It is intended only to provide heating and cooling for the cab area.

A small amount of air will blow out of the defrost and dash vents regardless of the mode settings.



Figure 15-4: Dashboard Controls

### XCITE RADIO SYSTEM (OPTIONAL)

Another option for your Allegro Bus is the Xcite Radio System. The Xcite System is equipped with AM, FM, and Sirius XM capabilities. It also comes standard with a Rand McNally Navigation System. The system comes with three monitors: the main monitor, the aux zone monitor, and the secondary passenger monitor. The main monitor and secondary passenger monitor have touch screen capabilities while the aux zone monitor does not.

## DRIVING

### CAMERA MONITORING SYSTEM (OPTIONAL)



Figure 15-6: Camera Dashboard View

The cameras (Figure 15-6) associated with the Xcite system will be the default setting on your Aux zone monitor. However, you are able to access the camera system on your main monitor in one of two ways.

One is by selecting the CAM button on the

main monitor, and the other is by pressing MENU on the main monitor and then selecting Camera.

Once the camera is on the main monitor, you can change the camera view to the left camera, right camera, or rear camera (Figure 15-5). Making this selection will change both your main screen and your aux zone screen to this camera view.

#### Three Sixty (360) Camera (Optional)

The 360 Camera gives you the ability to view all sides of your unit and even the top. (Figure 15-2a). To activate the system, depress MENU and select HD CAM.



Figure 15-5: View from Camera



Figure 15-2a: 360 Camera

---

**NOTE:** When the turn signals are activated, the main monitor will show the camera corresponding to the turn signal that was activated. When the turn signal is deactivated, the main monitor will then return to its previous state.

---



## DRIVING

### SECONDARY PASSENGER MONITOR (OPTIONAL)



Figure 15-7: Passenger Monitor

To change the default view of your Aux Zone monitor and/or your secondary passenger monitor (Figure 15-7), press the menu button on the main monitor, and then select the Aux Zone button. Once you are on the Aux Zone page, you will be able to toggle the views of the two aforementioned screens with options, such as camera, HDMLI, navigation, etc.

For more information regarding the Xcite system, refer to the Xcite manual that is provided with the motorhome.

### LEVELLING ZERO-SET

Levelling zero-set adjusts the level reference used when the vehicle is in AUTO or MANUAL levelling mode. This allows the system to level to the same level every time.

### MOBILEYE COLLISION MITIGATION SYSTEM

The Allegro Bus might be equipped with an optional Mobileye collision mitigation system that aids drivers in avoiding accidents. Features of the Mobileye collision mitigation system include the following:

- Forward collision warning indicates when a vehicle is detected in the same lane.
- Lane departure warning indicators are active above 34 MPH and if turn signals are not used when changing lanes.
- Headway monitoring and warning is active above 19 MPH and displays the number of seconds to the vehicle directly in front of you whenever that distance/time becomes 2.5 seconds or less.
- Pedestrian and bicycle collision warning indicators are active under 31 MPH.
- Intelligent, high-beam controls automatically switch headlights from low beam to high beam on dark roads without traffic.
- Speed limit indication is active at any speed and notifies the driver if the vehicle exceeds the allowed speed limit detected on speed signs.





## DRIVING

### **AFO SUPPLEMENTAL BRAKING SYSTEM**

Your BUS is equipped with the **Air Force One Supplemental** braking system. This system will provide years of maintenance and adjustment-free service. This proportional braking system uses the air pressure from your RV's brakes to apply the brakes in your towed car in the same manner. Low-profile design installs out of your way and is always at the ready. Please refer to the Manufacturer's manual, which is a part of your operator's packet.



### **ADAPTIVE CRUISE CONTROL**

Your 2022 Allegro Bus is equipped with ACC. This system combines stability control and collision mitigation with a dynamic cruise control system. We encourage you to learn more about each of the components from the chassis manufacturer's operation manual included in this binder.

# ALLEGRO BUS

## ROUTINE MAINTENANCE

---

Chapter

16

## ROUTINE MAINTENANCE

# NOTICE

**Damage caused by improperly performed maintenance or inadequate maintenance is not covered by your Tiffin Motor Homes limited warranty.**

## WASHING

The paint on your Tiffin motorhome has a polyurethane base called Diamont. While multiple layers of clear coat sealants protect the paint against oxidation, the sealant must be protected from deterioration (Figure 16-1).

Paint manufacturers advise against using harsh cleaners such as Simple Green, Mr. Clean, or liquid dish washing soaps. The degreasing agents in these cleaners leave a residue on the sealant, which soften and damage the clear coat in time.

Baby shampoo provides an effective yet gentle cleaner. Without the typical heavy degreasers of most detergents, baby shampoo cleans without leaving a residue to gum up the clear coat finish. Generally, one ounce (1 oz.) is all you need per five-gallon bucket of water. Add one cup of food grade distilled white vinegar to your wash bucket.

Tiffin Motor Homes recommends the lamb's wool pad sold by Mary Moppins. This enables you to safely wash your coach from the ground by placing the pad on an extension.

Do not mistake lamb's wool with imitations. Imitation pads are made from 100% polyester, which is plastic. Plastic imitations will scratch the finish of the motorhome. For this same reason, avoid microfiber products to wash or dry your motorhome. Microfiber is made from 80% polyester.



Figure 16-1: Typical Motorhome Exterior



## CAUTION

**DO NOT use any type of brush or plastic wash materials on the exterior paint as this could cause damage to the finish of your motorhome. Even though you might not see brush marks now, the damage will happen as the bristles wear down.**

## ROUTINE MAINTENANCE

Use only 100% cotton towels to dry your vehicle. Adding vinegar to your wash water and washing in the morning or evening will help prevent water spots. Water spots damage the exterior of your coach the same way they damage glass shower doors. They etch their way into the surface and removal becomes difficult. Prevention becomes the key.

Wash one side at a time, rinse, and then dry quickly using a squeegee followed by a towel placed over the cleaning head.

To remove oil and grease, remember an important rule of cleaning: give your product time to work. Dab a bit of concentrated cleaner like CleanEz by Mary Moppins—never an orange-based cleaner or one with petroleum distillates—onto a soft cloth. Apply to the oil spot and wait for 10 to 15 minutes before rubbing lightly to remove the oil. Rinse immediately.

## SEALS

The seals around the doors, windows, vents, slide-out trim and external seams must be checked at least semi-annually. Additionally, the roof seams must be inspected for cracking or peeling semi-annually. If deterioration is noted during a routine maintenance inspection, reseal the seams or seals with an approved sealant to prevent leaks.

Your Tiffin Motor Homes dealer can perform resealing inspections and subsequent work for you. Tiffin Motor Homes recommends that a Tiffin Motor Homes authorized service center perform these inspections periodically and perform necessary resealing when necessary.

## PROPER SEALANTS FOR APPLICATION

The following sealants are recommended for specific sealing applications, as noted in the table. These can be purchased through the Tiffin Motor Homes parts and service department by calling 256-356-0261.

RECOMMENDED SEALANTS FOR SPECIFIC SEALING APPLICATIONS	
SEALANT	APPLICATION
Plas-T-Code	Metal or fiberglass roof
Surebond #SB-140	Rubber laminated to metal roof and ALL SKYLIGHTS
Carlisle #502-LSW self leveling sealant	Rubber roof over wood base
Silicone sealant	To cover butyl and other sealants; not to be used as the main sealant
Parbond	To seal across tops of windows on exterior surfaces where silicone is not used

## ROUTINE MAINTENANCE

### NOTICE

Do not use solvents such as acetone, MEK, toluene, and the like on the decals. Any solvent including alcohol might soften and smear colors. Do not use lacquer thinner or paint thinner on decals. Do not overcoat the decals with clear paint. Do not allow gasoline or other fuels to come into prolonged contact with the decals. However, if this should occur, immediately flush the affected area with water.

## ROAD SALT AND OTHER ROAD TREATMENTS

While many owners do not normally operate their coach on salt or otherwise treated winter roads, the following is suggested: Thoroughly wash the exterior, the undercarriage, and the engine compartment of your coach. If you find it necessary to utilize a commercial wash service, refrain from using brushes or highly caustic wash agents on your coach. Also, when washing the engine compartment, always remain mindful of the electrical and electronic components. Do not spray high-pressure water directly on these components.

## WHEEL CARE

The care and maintenance of your wheels are simple and require no special material or products; follow the directions included in the Owner's Information Package for these. Timely care and cleaning will maintain the appearance of these wheel products for many years.

Be sure to completely wash the aluminum wheels free of all road treatment salt or other chemicals, paying close attention to the area behind the decorative lug nut covers.



### CAUTION

Do not use harsh detergents, acids, or abrasives, which might scratch or dull the surfaces. The applicator cloth, sponge, or soft-bristled brush must be non-metallic and non-abrasive. Also, remember to check the tightness of the wheel lug nuts frequently.

## ROUTINE MAINTENANCE

### ROOF CARE & MAINTENANCE

Proper care and maintenance of your motorhome, including your roof, is important for sustained, trouble-free performance. Normal maintenance is simple and easy and does not require special materials.

The roof of the motorhome is fiberglass and can be cared for in the conventional manner. Clean the roof at least every three months. The roof must be professionally inspected by a dealer annually.



### MOISTURE MANAGEMENT

This section outlines important recommendations to manage moisture in your motorhome to avoid moisture-related damage, such as mold. The materials and methods used to construct your motorhome were selected in part to minimize air leakage and to create a weather-tight exterior shell. However, in order to protect your investment, and reduce the risk of moisture-related damage and costly repairs, attention and care has to be taken to manage moisture inside your RV.

---

**NOTE:** These are only suggestions intended to minimize moisture-related issues with your motorhome. If any concerns arise, contact Tiffin Motor Homes' Service Department at (256) 356-0261.

---

### INTERIOR CARE OF YOUR RV

Signs of excessive moisture can be obvious, such as water droplets forming on surfaces or wet carpet. Conversely, signs of excess moisture can be subtle, such as condensation forming on metal surfaces. When symptoms appear, it is important to immediately determine the cause of the excess moisture and take appropriate corrective action to prevent moisture-related damage.

### CONTROL RELATIVE HUMIDITY

Monitoring and controlling relative humidity within the motorhome is one of the most important steps to minimize the risk for moisture-related damage. Ideally, relative humidity should be at 60% or less. Relative humidity can be monitored utilizing a portable hygrometer, which is a small device that measures temperature and relative humidity.



## **ROUTINE MAINTENANCE**

Use exhaust fans, the air conditioner, and/or a portable dehumidifier to manage moisture inside the RV to maintain relative humidity at 60% or less. In cold climates, relative humidity might need to be at 35% or less to avoid window condensation issues. If the motorhome is used, the majority of the time in a hot, humid climate, it might be difficult to keep relative humidity below 60%. A dehumidifier will help, but check the condensation (water) collection bucket regularly or discharge the condensation (water) directly to a drain.

### **AVOID DRASTIC THERMOSTAT SETBACKS**

To minimize the opportunity for condensation to form on interior surfaces, maintain a comfortable temperature in your RV, and avoid nighttime setbacks of 10 degrees or more. Drastic setbacks that reduce the indoor air temperature quickly can increase the chance for airborne moisture to condense on cool surfaces such as windows. If you are away from your RV for an extended number of days, do not set the temperature back without taking other measures to manage relative humidity, including operating a dehumidifier with a continuous drain.

### **MANAGE WINDOW CONDENSATION**

Window condensation issues can be identified by water or ice build-up, usually at the base of the window. The majority of these problems can be addressed by managing moisture generated inside the motorhome. Minor condensation issues are not unusual, especially for RVs used in colder climates. To help minimize window condensation, use exhaust fans vented to the outside, avoid drastic changes in thermostat settings, do not use “vent-free” heaters, and use window coverings wisely. For example, make sure to open curtains or blinds during the day to allow air to circulate and warm the window surface.

### **CARPET CARE AND MOISTURE MANAGEMENT**

The carpet must be cleaned when it shows signs of discoloration or traffic patterns. A steam cleaning system must be used to clean the carpet unless otherwise noted in your warranty information. To manage moisture from the cleaning process, the cleaning system needs to be capable of extracting the excess water from the carpet after it has been cleaned.

---

**IMPORTANT:** Be sure the carpet is thoroughly dry before closing up the RV for storage. Water from the cleaning process can cause significant damage to the RV if the carpet is not completely dry before closing up the motorhome for an extended period.

---

### **CLEANING TILE AND WOOD FLOORS**

Most floors only require a mild detergent and warm water for cleaning. More water on the floor is not always better for cleaning. Use a damp cloth to clean on a regular basis rather than wet mopping each time.

### **STORAGE AND OTHER ISOLATED AREAS WITHIN THE RV**

Storage areas are more difficult to condition since the areas are isolated from the main body of the RV. The surfaces of these areas are more at risk for condensation and surface mold growth. To minimize this

## **ROUTINE MAINTENANCE**

risk, clean storage areas regularly, and allow an air space between stored items and the exterior wall to promote air circulation.

### **USE OF UN-VENTED COMBUSTION EQUIPMENT**

Un-vented combustion equipment, such as propane stovetops are a source of moisture within the RV. For every gallon of fuel consumed, approximately one gallon of water vapor is evaporated into the air. Whenever possible, operate an exhaust fan in combination with the use of any un-vented combustion appliance within the RV. Water vapor and other combustion by-products must be vented to the exterior of the RV. The RV owner must strictly follow use and maintenance instructions for safe operation of any combustion equipment, particularly un-vented equipment.

### **EXTERIOR CARE OF YOUR RV**

The exterior shell of the RV is the primary weather and moisture barrier. Over the life of the vehicle, the shell will require regular care and maintenance in accordance with other instructions for exterior care. The shell includes the roof, sidewalls, windows, doors, and under-floor of the vehicle. Particular attention needs to be devoted to ensure these components are maintained to ensure a tight barrier against bulk water intrusion. The shell must be inspected periodically for tears, gaps, and condition of sealants in accordance with this owner's manual. Areas that require maintenance must be resealed using a similar, high-quality sealant used by the manufacturer. Particular attention must be devoted to ensure the slide outs are functioning properly. Each time a slide out is used, it must be inspected to ensure proper operation and sealing. The slide out gaskets must also be inspected to ensure proper sealing when the slide out is operated.

### **USE OF YOUR RV**

The square footage of an RV is significantly less than that of a single-family residence. This fact alone will elevate the relative humidity because there is less volume of air to help absorb or dissipate the humidity. For example, showering and cooking create a lot of humidity in a small area. In these instances, use of an exhaust fan and opening windows should reduce the relative humidity, particularly when living in the RV for an extended period.

### **SEVERE ENVIRONMENTS**

Prolonged use of your RV in severe environments—for example in extremely cold or hot-humid climates, will require extra care and maintenance to avoid moisture-related issues. In both extremely cold and hot humid climates, more attention needs to be focused on controlling the relative humidity within the RV. It also might require the use of a portable dehumidifier to manage the relative humidity within an acceptable range.

### **STORAGE OF YOUR RV**

During periods when your motorhome is not in use, care must be taken to ensure that moisture sources are addressed. Ideal storage of your RV would be in an enclosed, climate-controlled environment. When this is not possible, the following steps must be taken to ensure moisture is controlled:

- Turn off all water sources.

## **ROUTINE MAINTENANCE**

- Turn off all combustion appliances.
- Drain the water tanks.
- Drain the water heater.
- Open all closets, cabinet doors, and drawers.
- Close all windows and entrance doors.
- Open a vent or a window enough to allow for some limited ventilation airflow, but not so far as to allow snow or rain to enter.
- When storing the RV in high humidity climates, add a dehumidifier drained to exterior to control the humidity inside the RV during storage.
- Refer to other sections of this owner's manual for additional recommendations.

## **MODIFICATIONS TO YOUR RV**

Consult Tiffin Motor Homes for guidance before making any modifications to your RV. It is important that changes be completed by a qualified service firm to ensure that moisture intrusion or accumulation problems do not occur.

## **WET AREAS**

Areas that are exposed to water spills or leaks must be dried as soon as possible and definitely within 24 to 48 hours. Drying areas quickly minimizes the chance for moisture damage and possible mold growth, which can begin to form colonies within 48 hours. A variety of methods can be used to help the drying process:

- Remove excess water with an extraction vacuum.
- Use a dehumidifier to aid drying.
- Use portable fans to move air across the surface.
- Because moisture is key to mold issues, treat all signs of condensation and spills seriously and deal with promptly. Failure to deal with a moisture issue promptly might cause more severe issues where none initially existed, or might make a small problem much worse.
- Learn to recognize signs of mold—do not paint over or cover up suspicious discoloration until you are sure it is not mold. The affected surface must first be cleaned and dried; residual staining may be painted.
- Be sure to understand and eliminate the source of moisture accumulation as a part of the cleanup. Otherwise, the same issues will reoccur.
- Small amounts of mold must be cleaned as soon as it appears. Small areas of mold must be cleaned using a detergent/soapy solution or an appropriate RV household cleaner. Gloves must be worn during cleaning. The cleaned area must then be thoroughly dried. Dispose of any sponges or rags used to clean the mold.

# ROUTINE MAINTENANCE

## TIRE & SAFETY INFORMATION

This portion of the Owner's Manual contains tire safety information as required by 49 CFR 575.6. The National Traffic Safety Administration (NHTSA) can be contacted at 1-888-327-4236. Their website is <http://www.safercar.gov> and their address is NHTSA, 400 Seventh St, S.W., Washington, D.C. 20590.

### SECTION ONE

The National Traffic Safety (NHTSA) has published a brochure (DOT HS 809 361) that discusses all aspects of Tire Safety, as required by CFR 575.6. This brochure is reproduced in part below. It can be obtained and downloaded from NHTSA, free of charge, from the following website: <https://one.nhtsa.gov/cars/rules/TireSafety/ridesonit/brochure.html>

Studies of tire safety show that maintaining proper tire pressure, observing tire and vehicle load limits, avoiding road hazards, and inspecting tires for cuts, slashes, and other irregularities are the most important things you can do to avoid tire failure, such as tread separation or blowout, and flat tires.

These actions, along with other care and maintenance activities, can also:

- Improve vehicle handling.
- Help protect you and others from avoidable breakdowns and accidents.
- Improve fuel economy.
- Increase the life of your tires.

This section presents a comprehensive overview of tire safety, including information on the following topics:

- Basic tire maintenance.
- Uniform Tire Quality Grading System.
- Fundamental characteristics of tires.
- Tire safety tips.

Use this information to make tire safety a regular part of your vehicle maintenance routine. Recognize that the time you spend is minimal compared with the inconvenience and safety consequences of a flat tire or other tire failure.

### Safety First-Basic Tire Maintenance

Properly maintained tires improve the steering, stopping, traction, and load-carrying capability of your vehicle. Under-inflated tires and overloaded vehicles are a major cause of tire failure. Therefore, as mentioned above, to avoid flat tires and other types of tire failure, you must maintain proper tire pressure, observe tire and vehicle load limits, avoid road hazards, and regularly inspect your tires.

### Finding Your Vehicle's Recommended Tire Pressure and Load Limits

Tire information placards and vehicle certification labels contain information on tires and load limits. These labels indicate the vehicle manufacturer's information including:

- Recommended tire size.

## **ROUTINE MAINTENANCE**

- Recommended tire inflation pressure.
- Vehicle capacity weight (VCW—the maximum occupant and cargo weight a vehicle is designed to carry).
- Front and rear gross axle weight ratings (GAWR—the maximum weight the axle systems are designed to carry).

**For motorhomes:** Both placards and certification labels are on a sticker that is located in the rear closet.

### **Understanding Tire Pressure and Load Limits**

Tire inflation pressure is the level of air in the tire that provides it with load-carrying capacity and affects the overall performance of the vehicle. The tire inflation pressure is a number that indicates the amount of air pressure—measured in pounds per square inch (psi)—a tire requires to be properly inflated. (You will also find this number on the vehicle information placard expressed in kilopascals (kPa), which is the metric measure used internationally).

Vehicle manufacturers determine this number based on the vehicle's design load limit, that is, the greatest amount of weight a vehicle can safely carry, and the vehicle's tire size. The proper tire pressure for your vehicle is referred to as the "recommended cold-inflation pressure."

Because tires are designed to be used on more than one type of vehicle, tire manufacturers list the "maximum permissible inflation pressure" on the tire sidewall. This number is the greatest amount of air pressure that can ever be put in the tire under normal driving conditions.

### **Checking Tire Pressure**

It is important to check your vehicle's tire pressure at least once a month for the following reasons:

- Most tires naturally lose air over time.
- Tires can lose air suddenly if you drive over a pothole or other object, or if you strike the curb when parking.
- With radial tires, it is usually not possible to determine under-inflation by visual inspection.

For convenience, purchase a tire pressure gauge to keep in your vehicle. Gauges can be purchased at tire dealerships, auto supply stores, and other retail outlets.

The recommended tire inflation pressure that vehicle manufacturers provide reflects the proper psi when a tire is cold. The term cold does not relate to the outside temperature. Rather, a cold tire is one that has not been driven on for at least three hours. When you drive, your tires get warmer, causing the air pressure within them to increase. Therefore, to get an accurate tire pressure reading, you must measure tire pressure when the tires are cold or compensate for the extra pressure in warm tires.

### **Steps for Maintaining Proper Tire Pressure**

1. Locate the recommended tire pressure on the vehicle's tire information placard, certification label, or in the owner's manual.
2. Record the tire pressure of all tires.

## **ROUTINE MAINTENANCE**

3. If the tire pressure is too high in any of the tires, slowly release air by gently pressing on the tire valve stem with the edge of your tire gauge until you get to the correct pressure.
4. If the tire pressure is too low, note the difference between the measured tire pressure and correct tire pressure. These “missing” pounds of pressure are what you will need to add.
5. At a service station, add the missing pounds of air pressure to each tire that is under-inflated.
6. Check all the tires to make sure they have the same air pressure (except in cases in which the front and rear tires are supposed to have different amounts of pressure).

If you have been driving your vehicle and think that a tire is under-inflated, fill it to the recommended cold-inflation pressure indicated on your vehicle’s tire information placard or certification label.

While your tire might still be slightly under-inflated due to the extra pounds of pressure in the warm tire, it is safer to drive with air pressure that is slightly lower than the vehicle manufacturer’s recommended cold-inflation pressure than to drive with a significantly under-inflated tire. Since this is a temporary fix, do not forget to recheck and adjust the tire’s pressure when you can obtain a cold reading.

### **Tire Size**

To maintain tire safety, purchase new tires that are of the same size as the vehicle’s original tires or another size recommended by the manufacturer. Look at the tire information placard, the owner’s manual, or the sidewall of the tire you are replacing to find this information. If you have any doubt about the correct size to choose, consult with the tire dealer.

### **Tire Tread**

The tire tread provides the gripping action and traction that prevent your vehicle from slipping or sliding, especially when the road is wet or icy. In general, tires are not safe and must be replaced when the tread is worn down to 1/16 of an inch. Tires have built-in tread-wear indicators that let you know when it is time to replace your tires. These indicators are raised sections spaced intermittently in the bottom of the tread grooves. When they appear “even” with the outside of the tread, it is time to replace your tires.

Another method for checking tread depth is to place a penny in the tread with Lincoln’s head upside down and facing you. If you can see the top of Lincoln’s head, you are ready for new tires.

### **Tire Balance and Wheel Alignment**

To avoid vibration or shaking of the vehicle when a tire rotates, the tire must be properly balanced. This balance is achieved by positioning weights on the wheel to counterbalance heavy spots on the wheel-and-tire assembly. A wheel alignment adjusts the angles of the wheels so that they are positioned correctly relative to the vehicle’s frame. This adjustment maximizes the life of your tires. These adjustments require special equipment and must be performed by a qualified technician.



## **ROUTINE MAINTENANCE**

### **Tire Rotation**

Rotating tires from front to back and from side-to-side can reduce irregular wear (for vehicles that have tires that are all of the same size). Look in your owner's manual for information on how frequently the tires on your vehicle must be rotated and the best pattern for rotation.

### **Tire Repair**

The proper repair of a punctured tire requires a plug for the hole and a patch for the area inside the tire that surrounds the puncture hole. Punctures through the tread can be repaired if they are not too large, but punctures to the sidewall must not be repaired. Tires must be removed from the rim to be properly inspected before being plugged and patched.

# ROUTINE MAINTENANCE

## A Tire Rotation Example

For maximum mileage, rotate your tires every 5,000 miles. Follow correct rotation patterns.

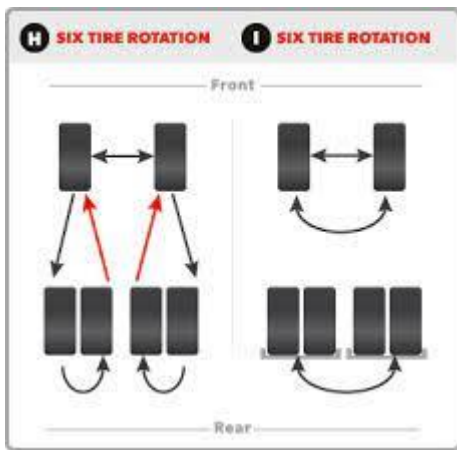
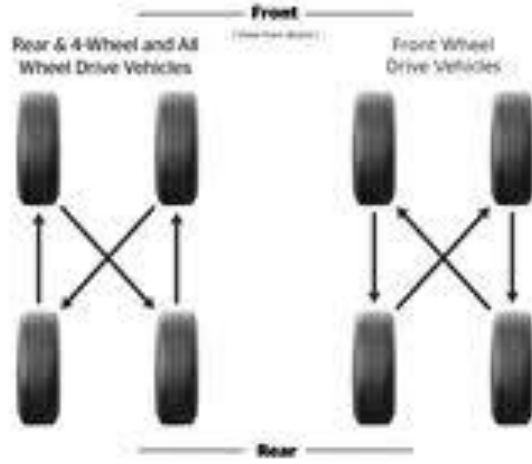
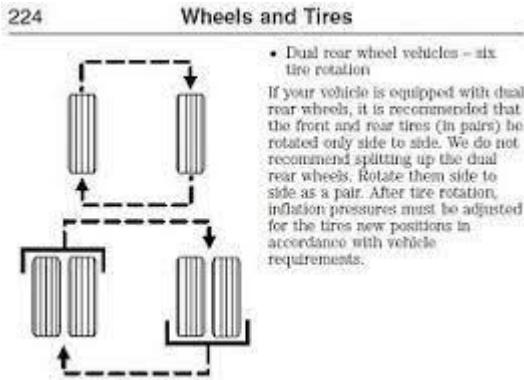
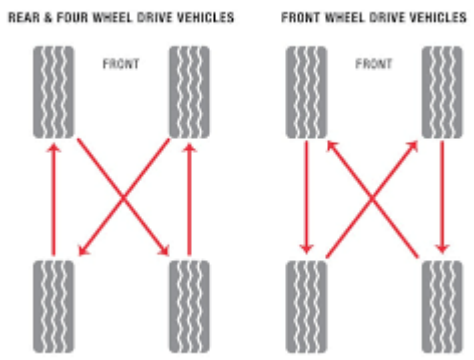
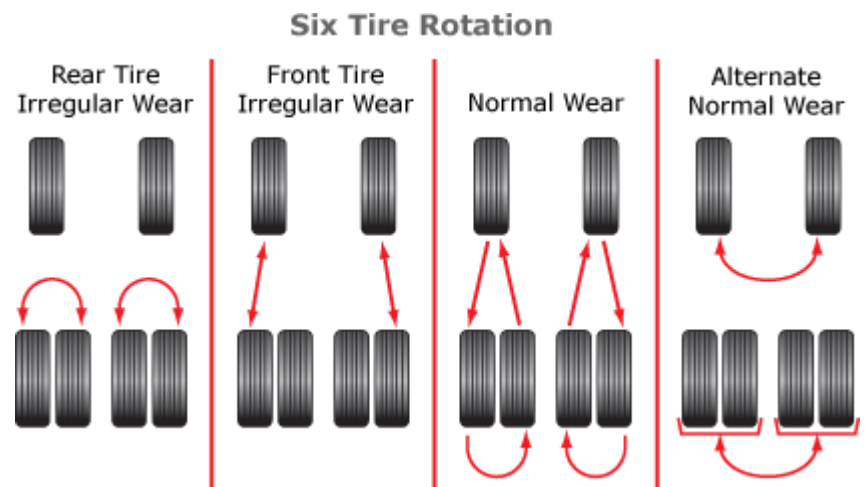

Figure 16-2: Rotation



Tire



## ROUTINE MAINTENANCE

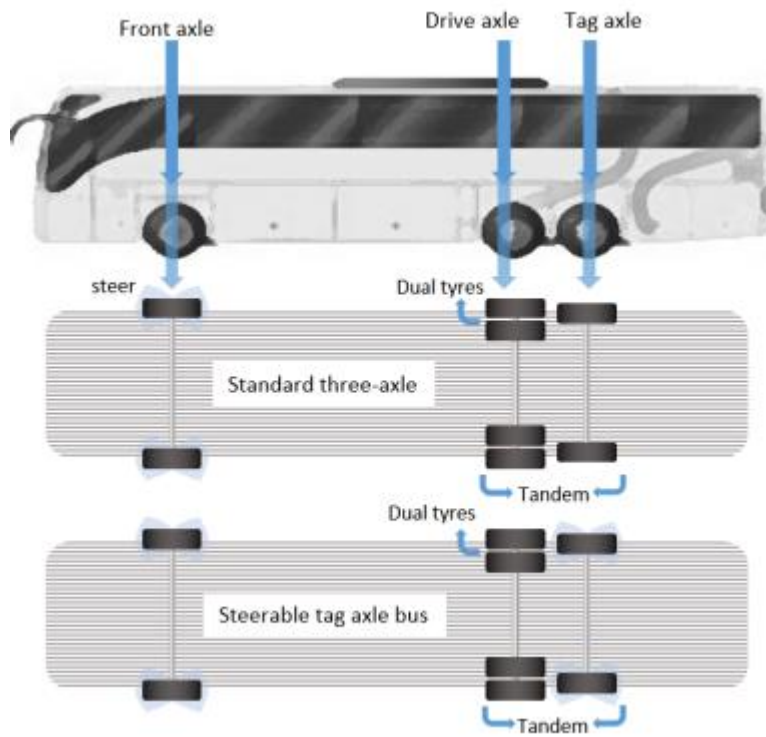

Three-axle diagram from the side and underneath perspectives

# ROUTINE MAINTENANCE

## Information on Passenger Vehicle Tires

# TIRE SIDEWALL MARKINGS

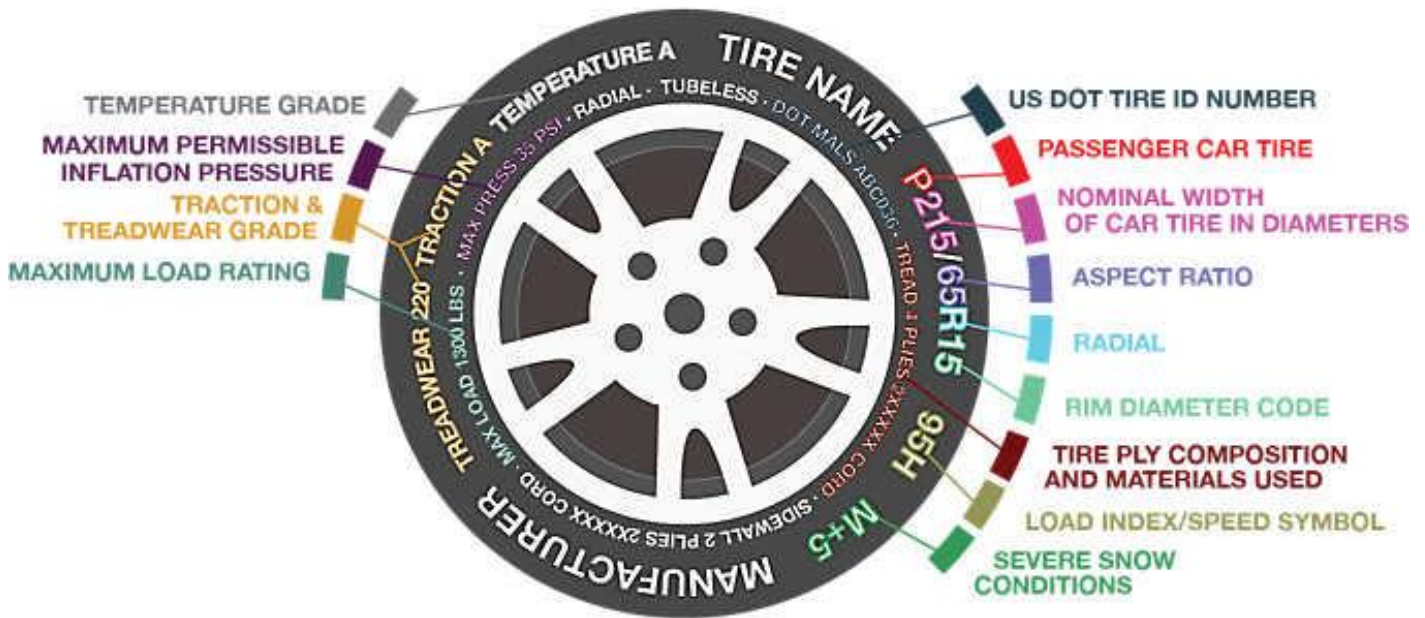

Figure 16-3: Vehicle Tire Information

P—The “P” indicates the tire is for passenger vehicles.

**NOTE:** Passenger car tires are not recommended for use on trailers, because the capacity ratings are not marked on the side walls of these tires. In the event that a passenger car tire is used, the capacity must be de-rated by 10%.

**Next number**—This three-digit number gives the width in millimeters of the tire from sidewall edge to sidewall edge. In general, the larger the number, the wider the tire.

**Next number**—This two-digit number, known as the aspect ratio, gives the tire’s ratio of height to width. Numbers of 70 or lower indicate a short sidewall for improved steering response and better overall handling on dry pavement.

R—The “R” stands for radial. Radial ply construction of tires has been the industry standard for more than 20 years.

**Next number**—This two-digit number is the wheel or rim diameter in inches. If you change your wheel size, you will have to purchase new tires to match the new wheel number.

**Next number**—This two or three-digit number is the tire’s load index. It is a measurement of how much weight each tire can support. You might find this information in your owner’s manual. If not, contact a local tire dealer.

**NOTE:** You might not find this information on all tires because it is not required by law.

## **ROUTINE MAINTENANCE**

**M+S**—The “M+S” or “M/S” indicates that the tire has some mud and snow capability. Most radial tires have these markings.

**Speed Rating**—The speed rating denotes the speed at which a tire is designed to be driven for extended periods of time.

**U.S. DOT Tire Identification Number**—This begins with the letters “DOT” and indicates that the tire meets all federal standards. The next two numbers or letters are the plant code where it was manufactured, and the last four numbers represent the week and year the tire was built. For example, the numbers 1612 means the 16th week of 2012. The other numbers are marketing codes used at the manufacturer’s discretion. This information is used to contact customers if a tire defect requires a recall.

**Tire Ply Composition and Materials Used**—The number of plies indicates the number of layers of rubber-coated fabric in the tire. In general, the greater the number of plies, the more weight a tire can support. Tire manufacturers also must indicate the materials in the tire, which include steel, nylon, polyester, and others.

**Maximum Load Rating**—This number indicates the maximum load in kilograms and pounds that can be carried by the tire.

**Maximum Permissible Inflation Pressure**—This number is the greatest amount of air pressure that should ever be put in the tire under normal driving conditions.

### **Vehicle Load Limits**

Determining the load limits of a vehicle includes more than understanding the load limits of the tires alone. On a motorhome, there is a federal certification label that is affixed in the rear closet. The certification label will indicate the vehicle’s gross vehicle weight rating (GVWR). This is the most weight the fully loaded vehicle can weigh.

It will also provide the gross axle weight rating (GAWR). This is the most a particular axle can weigh. If there are multiple axles, the GAWR of each axle will be provided. For motorhomes, in the same location as the certification label described above, there is a vehicle placard in the entry door frame. This placard provides tire and loading information. In addition, this placard will show the vehicle’s seating capacity for people and a statement regarding maximum cargo capacity.

### **Cargo Capacities**

For motorhomes, cargo can be added to the vehicle, up to the maximum weight specified on the placard. For motorized vehicles, the combined weight of passengers and cargo is provided as a single number. If fewer people are traveling, more cargo can be added. If more people are involved, the weight of cargo must be reduced. In any case, the total weight of a fully loaded vehicle, including passengers, cannot exceed the stated GVWR.

For motorhomes, the water and propane also need to be considered. The weight of fully filled propane containers is considered part of the weight of the RV before it is loaded with people or cargo and is not considered part of the disposable cargo load. Water, however, is a cargo weight and is treated as such. If there is a fresh water storage tank of 50 gallons, this tank when filled would weigh about 400 pounds. If more cargo or people are being transported, water can be off-loaded to keep the total amount of cargo added to the vehicle within the limits of the GVWR so as to not overload the vehicle.

## **ROUTINE MAINTENANCE**

Understanding this flexibility will allow you to make choices that fit your travel and camping needs. When loading your cargo, be sure it is distributed evenly to prevent overloading from front to back and side-to-side. Heavy items must be placed low and as close to the axle positions as reasonable. Too many items on one side might overload a tire.

The best way to know the actual weight of the vehicle is to weigh it at a certified public scale. Talk to your RV dealer to discuss the weighing methods needed to determine the various weights related to the RV. This will include weights for axles, wheels, hitch, and total weight.

### **How Overloading Affects Your RV and Tires**

The results of overloading can have serious consequences for passenger safety. Too much weight on your vehicle's suspension system can cause spring, shock absorber, or brake failure, handling or steering problems, irregular tire wear, tire failure, or other damage.

An overloaded vehicle is hard to drive and hard to stop. In cases of serious overloading, brakes can fail completely, particularly on steep hills. The load a tire will safely carry is a combination of the size of tire, its load range, and corresponding inflation pressure.

Excessive loads and/or under-inflation cause tire overloading and, as a result, abnormal tire flexing occurs. This situation can generate an excessive amount of heat within the tire. Excessive heat might lead to tire wear and eventually, tire failure.

It is the air pressure that enables a tire to support the load, so proper inflation is critical. Since RVs can be configured and loaded in many ways, air pressures must be determined from actual loads (determined by weighing) and taken from the load and inflation tables provided by the tire manufacturer. These air pressures might differ from those found on the certification label. However, they must never exceed the tire limitation for load or air pressure.

### **Tire Safety Tips**

#### **Preventing Tire Damage**

- Slow down if you have to go over a pothole or other object in the road.
- Do not run over curbs or other foreign objects in the roadway, and try not to strike the curb when parking.

#### **Tire Safety Checklist**

- ✓ Check tire pressure regularly (at least once a month), including the spare.
- ✓ Inspect tires for uneven wear patterns on the tread, cracks, foreign objects, or other signs of wear or trauma.
- ✓ Remove bits of glass and foreign objects wedged in the tread.
- ✓ Make sure your tire valves have valve caps.
- ✓ Check tire pressure before going on a long trip.



## ROUTINE MAINTENANCE

- ✓ Do not overload your vehicle. Check the Tire Information and Loading Placard or User's Manual for the maximum recommended load for the vehicle.

### SECTION TWO

#### Steps for Determining Correct Load Limit

1. Locate the statement "The combined weight of occupants and cargo should never exceed XXX lbs" on your vehicles placard.
2. Determine the combined weight of the driver and passengers that will be riding in your vehicle.
3. Subtract the combined weight of the driver and passengers from XXX kilograms or XXX pounds.
4. The resulting figure equals the available amount of cargo and luggage capacity. For example, if "XXX" equals 1400 lbs. and there will be five 150 lb. passengers in your vehicle, the amount of available cargo and luggage capacity is 650 lbs.  $(1400 - 750 (5 \times 150) = 650 \text{ lbs.})$
5. Determine the combined weight of luggage and cargo being loaded on the vehicle. That weight may not safely exceed the available cargo and luggage capacity calculated in Step #4.
6. If your vehicle will be towing a trailer, load from your trailer will be transferred to your vehicle. Consult this section to determine how this reduces the available cargo and luggage capacity of your vehicle.

### SECTION THREE

#### Glossary of Tire Terminology

**Accessory weight**—The combined weight (in excess of those standard items, which may be replaced) of automatic transmission, power steering, power brakes, power windows, power seats, radio and heater, to the extent that these items are available as factory-installed equipment (whether installed or not).

**Bead**—The part of the tire that is made of steel wires, wrapped or reinforced by ply cords and that is shaped to fit the rim.

**Bead separation**—This is the breakdown of the bond between components in the bead.

**Bias ply tire**—A pneumatic tire in which the ply cords that extend to the beads are laid at alternate angles substantially less than 90 degrees to the centerline of the tread.

**Carcass**—The tire structure, except tread and sidewall rubber which, when inflated, bears the load.

**Chunking**—The breaking away of pieces of the tread or sidewall.

**Cold-inflation pressure**—The pressure in the tire before you drive.

**Cord**—The strands forming the plies in the tire.

**Cord separation**—The parting of cords from adjacent rubber compounds.

**Cracking**—Any parting within the tread, sidewall, or inner liner of the tire extending to cord material.

## **ROUTINE MAINTENANCE**

**CT**—A pneumatic tire with an inverted flange tire and rim system in which the rim is designed with rim flanges pointed radially inward and the tire is designed to fit on the underside of the rim in a manner that encloses the rim flanges inside the air cavity of the tire.

**Curb weight**—The weight of a motor vehicle with standard equipment including the maximum capacity of fuel, oil, and coolant, and, if so equipped, air conditioning and additional weight optional engine.

**Extra load tire**—A tire designed to operate at higher loads and at higher inflation pressures than the corresponding standard tire.

**Groove**—The space between two adjacent tread ribs.

**Gross Vehicle Weight Rating (GVWR)**—The maximum permissible weight of this fully loaded motorhome.

**Gross Axle Weight Rating (GAWR)**—The value specified as the load carrying capacity of a single axle system, as measured at the tire-ground interfaces.

**Hitch Weight**—The vertical trailer load supported by the hitch ball.

**Innerliner separation**—The parting of the innerliner from cord material in the carcass.

**Intended outboard sidewall**—The sidewall that contains a white-wall, bears white lettering or bears manufacturer, brand, and/or model name molding that is higher or deeper than the same molding on the other sidewall of the tire or the outward facing sidewall of an asymmetrical tire that has a particular side that must always face outward when mounted on a vehicle.

**Light truck (LT) tire**—A tire designated by its manufacturer as primarily intended for use on light-weight trucks or multipurpose passenger vehicles.

**Load rating**—The maximum load that a tire is rated to carry for a given inflation pressure.

**Maximum load rating**—The load rating for a tire at the maximum permissible inflation pressure for that tire.

**Maximum permissible inflation pressure**—The maximum cold-inflation pressure to which a tire may be inflated.

**Maximum loaded vehicle weight**—The sum of curb weight, accessory weight, vehicle capacity weight, and production options weight.

**Measuring rim**—The rim on which a tire is fitted for physical dimension requirements.

**Non-pneumatic rim**—A mechanical device which, when a non-pneumatic tire assembly incorporates a wheel, supports the tire, and attaches, either integrally or separably, to the wheel center member and upon which the tire is attached.

**Non-pneumatic tire assembly**—A non-pneumatic tire, alone or in combination with a wheel or wheel center member, which can be mounted on a vehicle.

**Normal occupant weight**—This means 68 kilograms (150 lbs.) times the number of occupants specified in the second column of Table I of 49 CFR 571.110.

**Occupant distribution**—The distribution of occupants in a vehicle as specified in the third column of Table I of 49 CFR 571.110.

## **ROUTINE MAINTENANCE**

**Open splice**—Any parting at any junction of tread, sidewall, or innerliner that extends to cord material.

**Outer diameter**—The overall diameter of an inflated new tire.

**Overall width**—The linear distance between the exteriors of the sidewalls of an inflated tire, including elevations due to labeling, decorations, or protective bands or ribs.

**Pin Weight**—The vertical trailer load supported by the king pin of a fifth wheel hitch.

**Ply**—A layer of rubber-coated parallel cords.

**Ply separation**—A parting of rubber compound between adjacent plies.

**Pneumatic tire**—A mechanical device made of rubber, chemicals, fabric and steel, or other materials, that, when mounted on an automotive wheel, provides the traction and contains the gas or fluid that sustains the load.

**Production options weight**—The combined weight of those installed regular production options weighing over 2.3 kilograms (5 lbs.) in excess of those standard items which they replace, not previously considered in curb weight or accessory weight, including heavy duty brakes, ride levelers, roof rack, heavy duty battery, and special trim.

**Radial ply tire**—A pneumatic tire in which the ply cords that extend to the beads are laid at substantially 90 degrees to the centerline of the tread.

**Recommended inflation pressure**—This is the inflation pressure provided by the vehicle manufacturer on the Tire Information label and on the Certification/VIN tag.

**Reinforced tire**—A tire designed to operate at higher loads and at higher inflation pressures than the corresponding standard tire.

**Rim**—A metal support for a tire or a tire and tube assembly upon which the tire beads are seated.

**Rim diameter**—This means the nominal diameter of the bead seat.

**Rim size designation**—This means the rim diameter and width.

**Rim type designation**—This means the industry of manufacturer's designation for a rim by style or code.

**Rim width**—This means the nominal distance between rim flanges.

**Section width**—The linear distance between the exteriors of the sidewalls of an inflated tire, excluding elevations due to labeling, decoration, or protective bands.

**Sidewall**—That portion of a tire between the tread and bead.

**Sidewall separation**—The parting of the rubber compound from the cord material in the sidewall.

**Test rim**—The rim on which a tire is fitted for testing, and may be any rim listed as appropriate for use with that tire.

**Tread**—That portion of a tire that comes into contact with the road.

**Tread rib**—A tread section running circumferentially around a tire.

**Tread separation**—Pulling away of the tread from the tire carcass.

## **ROUTINE MAINTENANCE**

**Treadwear indicators (TWI)**—The projections within the principal grooves designed to give a visual indication of the degrees of wear of the tread.

**Vehicle capacity weight**—The rated cargo and luggage load plus 68 kilograms (150 lbs.) times the vehicle's designated seating capacity.

**Vehicle maximum load on the tire**—The load on an individual tire that is determined by distributing to each axle its share of the maximum loaded vehicle weight and dividing by two.

**Vehicle normal load on the tire**—The load on an individual tire that is determined by distributing to each axle its share of the curb weight, accessory weight, and normal occupant weight (distributed in accordance with Table I of CFR 49 571.110) and dividing by 2.

**Weather side**—The surface area of the rim not covered by the inflated tire.

**Wheel center member**—In the case of a non-pneumatic tire assembly incorporating a wheel, a mechanical device which attached, either integrally or separably, to the non-pneumatic rim and provides the connection between the non-pneumatic rim and the vehicle; or, in the case of a non-pneumatic tire assembly not incorporating a wheel, a mechanical device which attaches, either integrally or separably, to the non-pneumatic tire and provides the connection between tire and the vehicle.

## **TIRE PRESSURE**

Correct tire inflation pressure is essential to maximizing the life of the tires and assuring the safety of the vehicle and its occupants. Driving with tires that are not correctly inflated for the load of the motorhome is dangerous and might cause premature wear, tire damage, and/or loss of control of the motorhome.

An underinflated tire will build up excessive heat that might actually approach the vulcanization temperature of the rubber and lead to tread separation and/or disintegration of the tire.

Underinflated tires will also cause poor handling of the motorhome, rapid and/or irregular tire wear, and an increase in rolling resistance of the motorhome which, in turn, produces a decrease in fuel economy of operation.

An overinflated tire will reduce the tire's "footprint" (i.e., its actual contact with the road); thus, reducing the traction, braking capacity, and handling of the motorhome. A tire that is over-inflated for the load that it is carrying will also contribute to a harsh ride, uneven tire wear, and the tire itself will be more susceptible to impact damage.

Maintaining correct tire pressure for each loaded wheel position on the motorhome is critically important and must be a part of regular vehicle maintenance.

### **Tire Maximum Load Rating**

Federal law requires that the maximum load rating be molded into the sidewall of the tire. If you look at a tire sidewall, you might see some "typical" information, such as:

**Max. Load Single 3640 Lbs at 85 psi cold**

**Max. Load Dual 3415 Lbs at 85 psi cold**

## ROUTINE MAINTENANCE

The maximum load allowed for the size of the tire and load rating and the minimum cold air-inflation pressure needed to carry that stated maximum load are noted on the tire. Using less air pressure would reduce the load-carrying capacity of the tire.

---

**NOTE:** The amount of air pressure you need depends on the weight of the fully loaded motorhome. You cannot determine the correct air-inflation pressure, unless you know the actual weights of the motorhome.

---

### Frequency of Checking Tire Inflation Pressures

When you have determined the “correct” tire inflation pressures for each of the motorhome tires (Figure 16-4 and Figure 16-5) and inflated the tires under “cold” conditions, meaning the tires haven’t been driven for more than one mile, then the air pressures in the tires must be periodically checked to make sure that they retain their proper pressures. It is recommended that tire pressures be checked at least once a month, or preferably, every two weeks, and before any major trip.

On long trips, the tires must be checked every “drive” morning. On short trips (a day or less), the tires must be checked before one departs on the trip and again before one returns home.

Check tire pressures when they are “cold”; that is, the tires have not been driven at all or, at most, less than one mile before being measured. In this manner, the tire pressure has not been increased by the heating associated with tire sidewall and tread flexure associated with traveling. If you check tires that are warm or hot, remember that they will necessarily read higher than normal. Do not “bleed” these tires down to the “cold pressure” readings, as they will probably then be underinflated when they are actually cool.

Do not make any adjustments to tire pressures when the tires are warm or hot, if such can be avoided. To make these tire-pressure measurements, purchase a high-quality truck-tire air gauge, which has an angled dual head. This type of gauge enables you to check inflation pressures of both the inner dual wheel, which has the valve stem pointing toward one, and on the outer wheel, which has the valve stem pointing away from one.

Pressure-sealing valve caps must always be used to protect the valve stems and prevent air from escaping from the valve stems



Figure 16-4: Rear Tire



Figure 16-5: Front Tire

## **ROUTINE MAINTENANCE**

### **Weighing the Motorhome**

Earlier, in Chapter 1, the procedures for weighing the motorhome were presented. These procedures provided the weighing of a “non-loaded” (i.e., not stocked with the possessions and provisions the user would normally have onboard for travel) motorhome. Obviously, any additional weight stored onboard (inside and underneath) the motorhome will contribute to the overall weight of the motorhome.

If not stored uniformly throughout the motorhome, additional weight of the possessions and provisions of the motorhome user will load each axle and each tire differently (front-to-rear and side-to-side distribution of that additional weight). Accordingly, **it is necessary to weigh the motorhome fully loaded as the user would have it for travel.** Moreover, **it is necessary to weigh each tire position individually.**

Overloading the motorhome can produce problems with the tires, wheels, springs, brakes, drive train, and other motorhome assemblies. In addition, an overloaded motorhome uses more fuel, is more difficult to handle properly, and can lead to driver fatigue more quickly. In a worst-case condition, if any component should fail, this could result in loss of control of the motorhome and subsequent damage.

# ROUTINE MAINTENANCE

In certain states, the Highway Patrol routinely weighs motorhomes to check for overloaded axle weights. Therefore, there are many good reasons for assuring that the motorhome is properly loaded and not overloaded—this can be accomplished through a proper weighing of the fully loaded motorhome.

## A brief overview of the procedure for weighing the motorhome WEIGHING YOUR SINGLE AXLE RECREATIONAL VEHICLE

### RV: To Obtain Individual Axle and Gross Vehicle Weights:

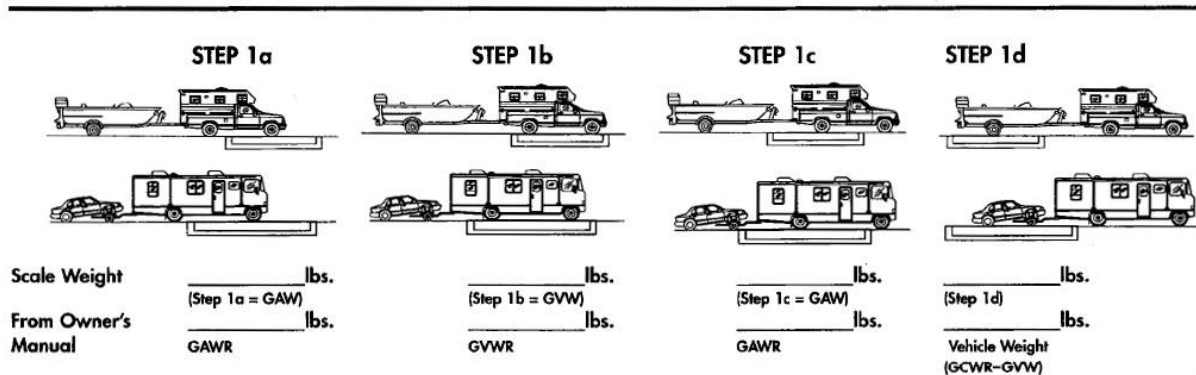

### To Obtain Individual Wheel Position Weights:

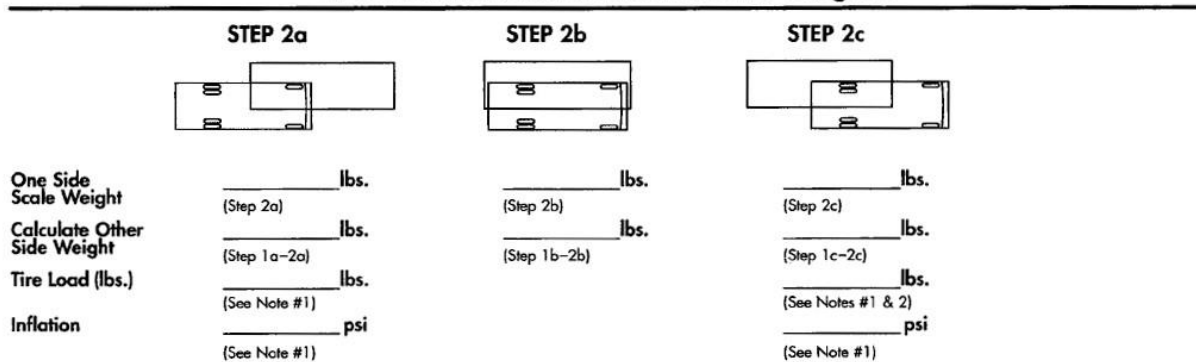

You can find various places that have certified public scales where your motorhome can be weighed. For example, moving and storage company lots, farm suppliers with grain elevators, gravel pits, recycling companies, and large-scale commercial-truck stops are some of the possible locations for weighing the motorhome. You can also check the Yellow Pages of the telephone book for “scales – public” or “weighers” to determine other locations for weighing the motorhome.

Figure 16-6: Motorhome Weighing Procedures

**NOTE:** Tire manufacturer’s load and inflation tables can be found on the sidewall of the tires mounted on the motorhome.

**NOTE:** If the motorhome has duals, read dual capacity from the tire and multiply by 2 (two) to obtain dual-assembly load-carrying capacity.



## ROUTINE MAINTENANCE

More detailed information can be found in the manufacturer's literature associated with the chassis and/or the tires provided with the motorhome. For example, the above graphic illustrates the inflation pressures for Michelin tires as a function of the loads per position for a specified speed of the motorhome. You can determine the appropriate inflation pressures for each of the tires on the motorhome, as a function of the loads they are to carry on a trip. Whenever there is a significant change in the loading regimen of the motorhome, it would be wise to re-calculate the load weights of the tires to ensure optimal use of the motorhome.

### Tire Wear, Balance, and Wheel Alignment

In addition to tire inflation considerations, the tires must also be periodically examined for other types of normal "wear and tear." If installed and maintained properly, all tires mounted on the motorhome must wear in a smooth, even pattern. If the tires begin to show irregular wear patterns and the motorhome alignment is still correct, then sometimes just rotating the tires by changing wheel position and rotation of the tires will allow the tires to wear evenly.

Check with the chassis manufacturer (Power Glide) and its literature in the Owner's Information Package for particulars on maintaining proper wheel alignment.

### Tire Cleaning

Proper cleaning of the tires will ensure maximum years of service. A soft brush and the normal mild soap must be used to clean the tires. Use care in applying any tire "dressing" product as these contain petroleum derivatives, alcohol, or silicones, which might cause deterioration of the rubber, possibly leading to cracking, and accelerate the aging process. In many instances, it is not the actual dressing itself, but the reaction of that product with the antioxidant in the tire. Heat can also compound this problem.

## INTERIOR CARE

### NOTICE

**The fading of upholstery, carpet, and other interior fabrics is generally caused by excessive sunlight. The drapes, blinds, or other shades must be kept closed when the vehicle is parked for an extended period of time to minimize the fading. Normal deterioration of the appearance of such items caused by wear and/or exposure to strong lighting is not covered by the Tiffin Motor Homes Limited Warranty.**

### Carpet

A weekly routine of vacuuming the carpet and fabrics throughout the vehicle is recommended. The optional vacuum system has a central connection within the motorhome wherein a vacuum hose can be connected and the necessary vacuuming performed, as desired.

## ROUTINE MAINTENANCE

Remember to empty or replace vacuum bags before they become overly full—this practice will ensure that sufficient vacuuming capability is readily available to handle all cleaning situations that might arise. In carpet areas that receive the most sunlight, keeping the curtains closed whenever possible will minimize fading. Also, act quickly when anything is spilled or dropped onto the carpet to prevent or minimize staining.

To connect the cleaning hose, raise the wall remote inlet valve door and align hose-end coupling with the slots on each side of the intake opening. Firmly push into the intake opening. Make sure the hose-end coupling is connected and is locked in place. To disconnect the hose, push in the slots on each side of the hose coupling and pull the hose end straight out.

---

**NOTE:** The vacuum cleaner hose must be plugged into the outlet to activate the vacuum motor.

---

### To start the vacuum cleaner:

1. Lift inlet valve cover on the wall.
2. Insert the hose cuff with a twist and push. The vacuum cleaner will start automatically.
3. To remove, turn the hose in either direction while pulling the hose toward you.

To change the dust bag, you will need to open the door on the vacuum cleaner by pushing the latch upward and removing the door completely. Remove the full bag and discard. Next, locate the pipe inside the vacuum chamber. Holding the new bag's cardboard collar at approximately a 45 degree angle, insert the cardboard part of the bag against the upper back of the vacuum cleaner chamber behind the pipe. Lift the front of the collar over the pipe as far as possible.



## WARNING

**This appliance has a THERMAL PROTECTOR built in the motor to prevent overheating. If the motor will not operate or shuts down while in operation, wait for 30 minutes; it will reset automatically. Turn the unit OFF while it resets. If the motor does not come on, or Thermal Protector trips off again after a short period, service might be needed. A qualified service technician must perform the service.**

When closing the door, tuck in the left and right corners of the bag so that the door is properly sealed and the latch clicks into place. The vacuum cleaning system comes with an array of attachments that can be connected to the hose ends for extensive cleaning purposes. Make sure they are firmly pushed in, and twist to hold in place.

## ROUTINE MAINTENANCE

For further instructions to change the dust bag, use the attachments, and proper cleaning technique, refer to the specific Owner's Manual located in your motorhome.

### FABRICS

The fabrics (Figure 16-7 and Figure 16-8), used in this Tiffin motorhome for the bedspread, draperies, headboard, and valances contain fire-retardant additives that might be damaged by use of improper cleaning products.

These items are DRY CLEAN ONLY. Water-based products are not recommended for cleaning the fabrics in your new vehicle. Most water-based, household-cleaning products are not formulated for use on these fabrics and might cause excessive shrinkage or fading. For best results, the fabrics in this vehicle must be cleaned by a professional carpet and upholstery cleaner.



Figure 16-7: Furniture Fabrics



Figure 16-8: Bedroom Fabrics

Spills, spots, or stains must be treated as soon as possible to avoid permanent damage to the fabrics. If a spill occurs, blot the fluid with a dry towel, do not rub the spill as rubbing might cause the liquid to “set” in the fabric and cause a stain. When attempting to clean a spot or stain, always start from the outside and work inward to avoid spreading the stain further. Some stains or soils are extremely difficult or impossible to be removed completely. These stains must receive immediate professional attention. Spills, spots, stains, or soiled areas are the responsibility of the owner and are not covered by Tiffin Motor Homes Limited Warranty.



## WARNING

**When cleaning the upholstery and fabric of the motorhome, do not use lacquer thinner, nail polish remover, laundry soaps, or bleach. Never use carbon tetrachloride or gasoline for cleaning purposes. These substances might cause damage to the materials being cleaned and most are highly flammable.**

## ROUTINE MAINTENANCE

### WALLS & CEILING

The wall and ceiling coverings must be cleaned periodically to maintain a new appearance. Use a non-abrasive cleaner with a soft cloth on the walls. Do not use solvents of any kind, as those solvents might damage the surfaces being cleaned.

### DASHBOARD

To keep the motorhome dashboard (Figure 16-9) in like-new condition, regularly follow these guidelines:

#### DOs

- Dust and clean the dashboard with a soft, damp cloth or chamois, wiping the service gently.
- Use a mild detergent and lukewarm water.
- After washing and rinsing the dashboard, dry it by blotting with a damp cloth or chamois.



Figure 16-9: Dashboard

#### DON'Ts

- Use harsh chemicals that might damage the dashboard.
- Use cloths containing grit or abrasive particles or kitchen-scouring compounds to clean or dust the dashboard.
- Subject the dashboard to hard, direct blows.
- Use boiling water, strong solvents, or other such materials to clean the dashboard, as they will soften the plastic.

### WOODWORK & FLOORS



Figure 16-10: Wood Cabinetry

The wood cabinetry must be cared for with furniture polish to sustain the natural beauty and luster of the wood. This procedure will also keep the cabinetry (Figure 16-10) looking new, prevent the wood from drying, and reduce chances of accidental staining or aging.

Use area rugs and floor mats by the entrance door to trap dirt.

## ROUTINE MAINTENANCE

Use soap and water to clean the flooring, begin by vacuuming the floor to remove loose dust and dirt. Then, damp mop the floor with a cleaning solution consisting of any standard cleaning solution. The mop must be damp, but not dripping. For further tips, see the manufacturer's information sheet in your Tiffin Motor Homes Owner's Information Package.

## COUNTERTOPS

To care properly for the countertops in your new vehicle, always use a heat pad or trivet to protect the surface from hot objects that might mar or damage the countertop surface. Hot pans and heat-producing appliances (such as electric skillets), when set directly on top of the countertop, can possibly mar the beauty and finish of the product.

Additionally, since heat-producing appliances can also damage countertop seams, it is essential to check with Tiffin Motor Homes to identify seam locations to avoid them during subsequent use of the motorhome. Although solid surfacing is repaired easily, certain steps must be taken to protect it.



Figure 16-11: Kitchen Countertops

Be sure to use a cutting board, rather than cutting directly on the countertop (Figure 16-11) surfaces. Although minor scratches and cuts can be repaired, a little care will ensure that the counter-top surfaces will keep looking new for years.

Avoid using harsh chemicals on the countertop. Wipe the countertop with a damp cloth to remove water spots. For most dirt and stains, wipe with a damp cloth and use soapy water or ammonia-based cleaners (e.g., Windex). If a stain does not respond to soap and water, for a matte finish, apply an abrasive cleanser and buff it with a Scotch-Brite pad, using a circular motion. Use the same technique in the case of a cigarette burn. If the finish is a gloss finish, contact the dealer for specific cleaning instructions.

Do not expose the surface to harsh chemicals, such as paint remover, turpentine, nail polish remover, or any stove and drain cleansers. If these chemicals come into contact with the countertop surfaces, immediately wash off these chemicals, using appropriate safety measures to avoid injury.

In the event of subsequent staining or spotting, sand the affected surface lightly with fine sandpaper (400 grit or finer), then buff in a circular motion with a Scotch-Brite pad.

## ACCESSORIES

The metallic light fixtures, bath accessories, and faucets can be cleaned by wiping with a soft, damp cloth. Washing with warm water will remove dry water spots. Polishing those fixtures with a soft cloth will also enhance their appearance. Do not use cleaners that contain harsh or abrasive chemicals. Alcohol or other similar solvents must never be used.



## ROUTINE MAINTENANCE

### DETECTORS

The CO/LP gas detectors (Figure 16-12) are self-contained and DO NOT require any maintenance other than normal cleaning and periodic testing. The smoke detector installed in the motorhome is a 9 volt, battery-operated detector. The CO/LP gas detector is wired directly to the house batteries.

The batteries in the smoke detector need to be tested periodically and replaced when necessary. When cleaning the case on any of the detectors, use a damp cloth or paper towel. Do not spray cleaners or wax directly into the case as this action might cause false alarms or hinder the normal operation of the detectors.

Tiffin Motor Homes recommends purchasing an inexpensive battery tester. This tester will allow checking of the batteries in the various alarms, any flashlights used in the motorhome, and batteries in other appliances, which might be in the motorhome during travels.

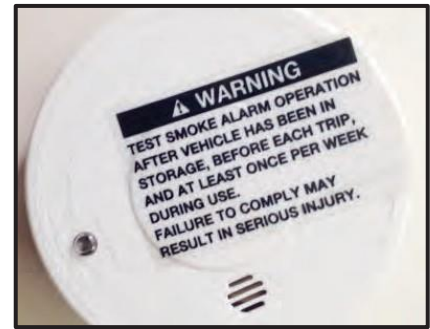

Figure 16-12: Smoke Detector

### CONDENSATION

## NOTICE

**Since surface condensation within the motorhome cannot be controlled by the manufacturer, damage caused by condensation is not covered by the Tiffin Motor Homes Limited Warranty.**

Damage might occur to your vehicle if excessive condensation exists. Accumulation of condensation on surfaces within your motorhome occurs when warm, moist air contacts a cool surface. It is most evident on the inside of windows, but this problem can be controlled by:

1. Slightly opening a window or roof vent to allow the moisture to escape from the motorhome.
2. Using a small dehumidifier to remove moisture from the air.

Condensation levels are highest during times when a person is cooking or taking a shower in the motorhome, but these occasions are not the only times that condensation is present. Walls and ceiling panels might become wet when the moisture accumulates on these surfaces. Tiffin Motor Homes does not recommend the use of any catalytic heaters because of resulting extensive condensation.

## ROUTINE MAINTENANCE

### ROUTINE MAINTENANCE SCHEDULES

#### NOTICE

**Always follow the chassis maintenance guidelines outlined in the chassis manufacturer's owner's manual.**

All routine maintenance is the responsibility of the owner and is not covered by the Tiffin Motor Homes Limited Warranty. Use the maintenance record in Chapter 17 to record all performed maintenance as required.

Any damage caused by improper or unperformed maintenance is not covered by the Tiffin Motor Homes Limited Warranty. Items supplied by other manufacturers might require specific individual maintenance not listed herein. Refer to the manufacturers' suggested maintenance guidelines in the Owner's Information Package.

#### NOTICE

**Cosmetic adjustments and alignments must be performed within the first three months from the date of original purchase for warranty consideration. Thereafter, these items are considered routine maintenance.**

#### Monthly

- Check the water levels of the batteries.

#### Every Three Months

- Check LP gas lines for leaks with soap solution or leak detector.
- Clean the microwave hood exhaust fan filter and blades.
- Test smoke alarm and carbon monoxide/LP gas detector.
- Check operation of windows, latches, and hinges.
- Clean the roof-ducted air conditioner filters.
- Clean and inspect door and window seals; reseal where necessary.
- Inspect and reseal around the tub and shower area where necessary.
- Lubricate the exterior door hinges and latches with a graphite (silicone) lubricant.
- Check, clean, and tighten battery cables and inspect batteries for proper fluid levels.



## ROUTINE MAINTENANCE

### Every Six Months

- Inspect the slide-out for proper seal. If realignment is necessary, contact an authorized Tiffin Motor Homes Service Center.
- Inspect the exterior rubber slide-out seals and apply a UV inhibitor, such as 303 Protectant.
- Change the battery in the smoke detector.
- Rotate tires as recommended by the tire manufacturer.
- Check all gas appliances for proper operation.
- Have the LP system inspected by a qualified technician.
- Lubricate the movable parts on the entrance step.
- Change the batteries in both the smoke detectors.
- For the optional washer/dryer, inspect the water hoses (both the hot and cold supply lines) to note any bulges, kinks, cuts, wear, or leaks. Especially note the hot-water hose, as this tends to degrade faster than the cold-water hose. Replace if hose feels “soft” or “spongy.”

### Annually

- Inspection of roof seams and joints must be performed by an authorized Motor Homes Service Center. If resealing is necessary, it is the owner’s responsibility and is not covered by the Tiffin Motor Homes Limited Warranty.
- Sanitize the fresh water system.
- Wax and buff all gel-coat surfaces on the vehicle as described previously in this chapter.

## WINTERIZING

To store your vehicle for the winter months, it is necessary to winterize the water system to help prevent freezing of this system. To do this, follow these instructions:

1. Drain all the water from the water system including the holding tanks and freshwater tank. Also, drain the water filter. For the holding tanks, open the gate valves to drain the tanks.

---

**NOTE:** This procedure is to be performed only at a wastewater pumping station to prevent dumping of contaminated water elsewhere.

---

Remove the filter cartridge from the water filter and store it in a clean environment. Empty any excess water from the filter housing and replace the housing.

2. Turn the by-pass valve located in the exterior sanitation compartment to the “by-pass” position to prevent filling the water heater tank with antifreeze.
3. Disconnect the inlet connection to the water pump located in the sanitary service compartment under the motorhome. Attach the supplied vinyl hose (through the plastic coupling on the hose) to the inlet connection and hand-tighten that connection. Do not over-tighten.

## ROUTINE MAINTENANCE

4. Place the other end of the hose into a gallon of freshwater system antifreeze (one can refer to the local Tiffin Motor Homes dealer or representative for the freshwater antifreeze formulation for your specific area).

---

**NOTE:** Do not use automotive antifreeze; use only antifreeze approved for RV applications. Otherwise, damage to the systems being protected might result.

---

5. Turn ON the water pump to start the flow of antifreeze. Turn ON each faucet, one at a time and allow pure antifreeze to run through that piping. Let about one cup drop into the drains to protect the traps.
6. When all the antifreeze is withdrawn from the bottle, disconnect the clear vinyl hose from the water-pump inlet connection and reconnect the inlet line to the water pump. (This might require more than one gallon of antifreeze).
7. When the winterizing process is completed, turn the water pump OFF and then reconnect the water line. Store the vinyl hose for future use.
8. Open the water supply valve that controls flow from the pump to the tank to help prevent freezing on that water line.

---

**NOTE:** The motorhome also has an exterior shower that must be winterized, as well.

---

If the motorhome is equipped with an optional icemaker, the following additional steps must be taken.

### Whirlpool Residential Refrigerator Ice Maker

1. Unplug refrigerator or disconnect power.
2. Locate the water supply shut off valve and turn OFF the water supply.
3. Disconnect the water supply line at the refrigerator and drain the supply line completely.
4. Locate the icemaker fill tube at the rear of the refrigerator and follow the water line down to the water valve.
5. Remove any covers if necessary.
6. Disconnect the water line from the water valve, and drain the water from the line and the valve. Use a small pan to catch water.
7. Remove the water filter cartridge (if applicable.)

---

**NOTE:** Reinstall a new water filter cartridge when the refrigerator is put back into service.

---

## DE-WINTERIZING

1. Open both of the low-point drains to allow the antifreeze solution to drain from the water system.
2. Close the low-point drains and connect your vehicle to the city water system. Put water in the freshwater tank and pump at least one gallon through the water pump to remove the antifreeze from the water pump. Keep the water heater in the bypass mode.

## **ROUTINE MAINTENANCE**

3. Open the kitchen faucet, bath faucet, and inside and outside showers, turning ON both the hot and cold-water valves, and flushing the stool until the antifreeze solution is flushed out of the system and the water flow is clear.
4. Open the water heater bypass valve. Open the freshwater tank supply valve from the pump and the icemaker valve.
5. Reinstall the (optional) water filter.
6. Be sure to close the fresh water tank drain valves to allow the tank to fill.

# ALLEGRO BUS

## MAINTENANCE & DATA CHARTS

---

Chapter

17

# RV OWNER DATA SHEET

Enter the following information in the table for your future use:

Allegro Bus: Year: _____ Model # _____ Tiffin Serial# _____			
Appliance	Brand	Model No.	Serial No.
Refrigerator			
Aqua-Hot			
Microwave			
Inverter/Converter			
Television, Front			
Back-up monitor			
Stereo/CD			
DVD home theater			
Air conditioner			
Generator			

**Reproduction Master** – Copy this sheet and use copy to maintain your maintenance records. You might wish to keep the completed sheets in a three-ring binder for your permanent record.



















# TIFFIN

MOTORHOMES

Tiffin Motor Homes, Inc. | 105 2nd St. NW | Red Bay, AL 35582

**[tiffinmotorhomes.com](http://tiffinmotorhomes.com)**

Phone: 256-356-8661 | Email: [customersupport@tiffinmotorhomes.com](mailto:customersupport@tiffinmotorhomes.com)

To view or download a full color, printable version of this owner's manual, visit

[www.tiffinmotorhomes.com/resources/owners-manual](http://www.tiffinmotorhomes.com/resources/owners-manual)

OR SCAN BELOW

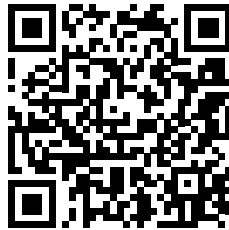

Because of progressive improvements and specifications, standard and optional equipment are subject to change without notice or obligation. For a complete and up-to-date list of available options and specifications, visit [tiffinmotorhomes.com](http://tiffinmotorhomes.com).

All trademarks and logos are owned or used under license by Tiffin Motor Homes, Inc. and include, but are not limited to: Tiffin®, Many Adventures. One Dream.™, Allegro®, Allegro Breeze®, Allegro RED®, Phaeton®, Allegro Bus®, Zephyr®, Wayfarer®, Roughing It Smoothly®, Open Road®, PowerGlide®, Cahaba®, Byway™, Convoy™, Bronze™, and associated logos and emblems. Unauthorized use of any trademark of Tiffin Motor Homes, Inc. is strictly prohibited. © Copyright 2024 Tiffin Motor Homes, Inc